



TECHNICAL DOCUMENT 3289
April 2016

**A Pictorial History of the
Code 717 Unmanned Systems
Group: Air, Land, and Sea
Volume 1: 1970–1999**

H. R. Everett

Approved for public release.

SSC Pacific
San Diego, CA 92152-5001

TECHNICAL DOCUMENT 3289
April 2016

**A Pictorial History of the
Code 717 Unmanned Systems
Group: Air, Land, and Sea
Volume 1: 1970–1999**

H. R. Everett

Approved for public release.



SSC Pacific
San Diego, CA 92152-5001

SSC Pacific
San Diego, California 92152-5001

K. J. Rothenhaus, CAPT, USN
Commanding Officer

C. A. Keeney
Executive Director

ADMINISTRATIVE INFORMATION

The work described in the first volume of the Pictorial History of the Code 717 Unmanned Systems Group covers the historical development of robotics at what is now Space and Naval Warfare Systems Center Pacific (SSC Pacific) from 1970–1999, when it was named Naval Ocean Systems Center (NOSC). The Autonomous Systems Branch (Code 422) and the Advanced Technology Development Branch (Code 535) paved the way for further developments in robotics that will be covered in Volumes 2 and 3.

Released under authority of
A. D. Ramirez, Head
Advanced Systems & Applied
Sciences Division

This is a work of the United States Government and therefore is not copyrighted. This work may be copied and disseminated without restriction.

IN MEMORIUM

This Pictorial History of the Code 717 Unmanned Systems Group at the Space and Naval Warfare Systems Center Pacific, San Diego, CA, is dedicated to the following members of our team whom we lost all too soon, and whose contributions and friendship we will never forget:

Joan Baker	1942–2008
William Thomas Gex	1952–2010
Susan P. Hower	1962–2015
Jeffrey Muehlhauser	1978–2003
ET1 Joseph Sadek, USNR	1957–2013
Captain Robert A. Wells, USN	1921–2012
Michael L. Wills	1957–2010

PREFACE

Due to the large number of projects involved, this Pictorial History of the Code 717 Unmanned Systems Group is chronologically presented in three successive volumes:

- Volume 1 (TD 3289) provides background information on the organizational structure, technology focus areas, key service areas, and facilities, followed by detailed project summaries for early work over the period 1970 through 1999.
- Volume 2 (TD 3301) continues the project-summary discussions for those efforts begun in 2000 through 2009.
- Volume 3 (TD 3302) continues the project-summary discussions for those efforts begun in 2010 through 2016.

This is Volume I.

CONTENTS

IN MEMORIUM	v
PREFACE	vi
INTRODUCTION	1
UNMANNED AIR VEHICLES	1
UNMANNED GROUND VEHICLES	2
UNMANNED SURFACE VEHICLES	3
UNMANNED UNDERSEA VEHICLES.....	4
BACKGROUND AND MISSION	5
ORGANIZATIONAL STRUCTURE	6
NAVSEA Office of Robotics and Autonomous Systems (SEA-90G).....	6
NOSC Autonomous Systems Branch (Code 442)	9
Advanced Systems Division (Code 53)	10
NOSC Autonomous Systems Branch (Code 535)	16
TECHNOLOGY FOCUS AREAS	29
Command, Control, and Communications.....	30
Autonomy.....	31
Perception.....	36
Data Mining.....	37
Visualization.....	39
KEY SERVICE AREAS	40
Evolutionary Systems Engineering.....	41
Standardized Test Methods	42
Rapid Prototyping	43
FACILITIES	46
PROJECT SUMMARIES	55
CHRONOLOGICAL PROJECT SUMMARIES (1970–1979)	55
<i>Remote Unmanned Work System</i> (1970-1980).....	55
CHRONOLOGICAL PROJECT SUMMARIES (1980–1989)	58
<i>ROBART I</i> (1980–1982).....	58
<i>Ground Surveillance Robot</i> (1981–1987)	65
<i>Remote-Presence Demonstration System</i> (1981–1985)	68

<i>ROBART II</i> (1982-1992).....	69
<i>Advanced Teleoperator Technology</i> (1983–1985).....	82
<i>Airborne Remotely Operated Device</i> (1984–1988).....	84
<i>Ground Air TEleRobotic System</i> (1985–1987)	86
<i>TeleOperated Vehicle</i> (1985–1989)	87
<i>Advanced Tethered Vehicle</i> (1986–1991)	95
<i>TeleOPerator Telepresence System</i> (1988–1992)	101
<i>Modular Robotic Architecture</i> (1988–1992)	102
CHRONOLOGICAL PROJECT SUMMARIES (1990–1999)	111
<i>Surrogate Teleoperated Vehicle</i> (1990–1992).....	111
<i>Mobile Detection Assessment Response System-Interior</i> (1990–2003)	115
<i>ROBART III</i> (1992–2007).....	131
<i>Mobile Detection Assessment Response System-Exterior</i> (1992–2011)	145
<i>Remote Vehicle Attitude Awareness</i> (1990–1992)	151
<i>Mission Payload Prototype</i> (1992–1994).....	157
<i>Air-Mobile Ground Security and Surveillance System</i> (1992–1996)	157
<i>Multipurpose Security and Surveillance Mission Platform</i> (1996–1997)	157
<i>Sensor Motor Transformation</i> (1993–1997).....	162
<i>Man-Portable Networked Sensor Package</i> (1997–1999).....	165
<i>DARPA Tactical Mobile Robotics</i> (1997–2003)	169
<i>Man-Portable Robotic System</i> (1999–2012).....	174
APPENDICES	
A – NAVSEA POLICY ON AUTOMATION AND ROBOTICS	A-1
B – WHITE PAPER PRESENTED TO ONR/ONT	B-1
C – CAPTAIN GARRITSON LETTER	C-1
D – NAVSEA MEMO TO NMPC	D-1
E – CENTER AND BRANCH NAMES	E-1
F – PATENT AWARDS AND APPLICATIONS	F-1
G – PROJECT HISTORY CHART	G-1
GLOSSARY	GLOSSARY-1
REFERENCES/BIBLIOGRAPHY	REFERENCES-1

“Those who cannot remember the past are condemned to repeat it.”

George Santayana

INTRODUCTION

From a military-application perspective, unmanned systems often serve as remotely operated or autonomous intelligence, surveillance, and reconnaissance (ISR) platforms, which is especially relevant for the following reasons:

- ISR is the primary mission for small unmanned surface vehicles (USVs) per the Navy *Unmanned Surface Vehicles (USVs) Master Plan (USVMP, 2007)*.
- ISR is the top priority mission according to the OPNAV N6/N7 *Unmanned Underwater Vehicles (UUVs) Master Plan (UUVMP, 2004)*.
- Urban ISR is a primary mission for small unmanned ground vehicles (UGVs) per the *Joint Robotics Program Master Plan (JRPMP, 2004)*.

Although the Code 717 Unmanned Systems Group has traditionally been more associated with ground robotics, the full scope of its involvement actually encompasses all operational domains of air, land, and sea, as further discussed below.

UNMANNED AIR VEHICLES

The Unmanned System Group’s involvement in the Unmanned Air Vehicle (UAV) domain began in the early 1980s in the form of an electrically powered quad-rotor platform intended to transport a remote-presence stereoscopic vision system for ISR missions. This feasibility prototype of the *Airborne Remotely Operated Device (AROD)* was developed by Moller International as a subcontractor to Perceptronics for the Hawaii Laboratory of the Naval Ocean Systems Center (NOSC), a predecessor organization of Space and Naval Warfare Systems Center Pacific (SSC Pacific). Code 717 has since expanded its air-domain involvement to include ducted-fan, helicopter, and fixed-wing aircraft, often mated to supporting UGVs (Figure 1).



Figure 1. Pilot and flight-electronics engineer Nick Stroumtsos, holding a 4-inch semi-autonomous Syma *Sky Thunder RC D63* quadrotor in his right hand, is surrounded by the Unmanned Systems Group’s growing fleet of unmanned aerial vehicles, circa March 2016.

As of January 2016, our growing collection of UAV assets included the following:

- One Allied Aerospace *iStar* ducted-fan vertical takeoff and landing (VTOL) UAV
- One Guided Systems helicopter with Piccolo flight management unit
- One spare airframe for a Guided Systems helicopter
- One Guided Systems electric helicopter
- One *Senior Telemaster* (fixed-wing) UAS with Piccolo flight-management unit
- One spare Piccolo flight-management unit
- One Arcturus *T-15* fixed-wing UAV with ground control station and launcher
- Three 3DRobotics *Iris* quadrotor UAVs
- One Applied Research Associates *Tactical Mini UAV (TACMAV)*
- Three AeroVironment *RQ-11A RavenA* aircraft with two ground control stations (on loan from PM-UAS)
- Six AeroVironment *RQ-11B RavenB* aircraft with three ground control stations (three on loan from PM-UAS)
- Three AeroVironment *RQ-20 Puma* UAVs and ground control stations
- One Aeryon *SkyRanger* UAS with ground control station (on loan from U.S. Pacific Fleet (USPACFLEET))
- One Black Diamond *MTS* common ground control unit
- Two Honeywell *RQ-16B T-Hawk* VTOL micro-air vehicles (MAVs) and control station

UNMANNED GROUND VEHICLES

The Code 717 Unmanned Systems Group at SSC Pacific has long been involved in ground robotics for two compelling reasons:

1. The Navy's joint-service explosive-ordnance-disposal (EOD) charter
2. Navy science and technology support for the United States Marine Corps

Under DoD Directive 5160.62, the Department of the Navy is formally assigned as executive manager for all DoD RDT&E involving EOD, and for decades robotics has been a big part of that picture. The Naval Surface Warfare Center (NSWC) Indian Head Explosive Ordnance Disposal Technology Division (IHEODTD), formerly Naval Explosive Ordnance Disposal Technology Division (NAVEODTECHDIV), manages UGV acquisition and development for Joint EOD operations under the auspices of the Naval Sea Systems Command (NAVSEA). SSC Pacific provides technical support to IHEODTD for the man-portable robots used to neutralize improvised explosive devices (IEDs), the number-one threat faced by warfighters in Iraq and Afghanistan.

As of January 2016, the Unmanned Systems Group's collection of teleoperated man-portable UGV assets included the following:

- Five iRobot *PackBots*
- Nine QinetiQ *Talons*
- Nine EOD Performance *Vanguard* robots
- One four-wheel *Segway* robot
- Two tracked *Segway*-based robots
- Numerous smaller ground robots

The autonomous ground vehicles under development onsite included:

- Two commercial *Rzrs* with drive-by-wire kits
- One militarized *Rzr* with drive-by-wire kit

- One Polaris *Ranger* with QinetiQ drive-by-wire kit
- One roboticized drive-by-wire Ford *Escape*
- One roboticized *High-Mobility Multi-Wheeled Vehicle (HMMWV)*
- One custom-built *RaDER* UGV

The Unmanned Systems Group also has a dozen or so one-of-a-kind historical ground robots in the museum area in Building 624, Seaside (Figure 2).



Figure 2. Ground robots in the museum area of Building 624 (left to right across the back wall) include two *ModBots*, A *Denning Sentry*, an *MDARS-Interior* security robot, *ROBERT I*, *ROBERT II*, and *ROBERT III*. An *iRobot All Terrain Robotic Vehicle* is at image center, with the original prototype of the *URBOT* at lower right. A few prototype ducted-fan air vehicles are at foreground left.

UNMANNED SURFACE VEHICLES

The Code 717 Unmanned Systems Group has an extensive history in developing component technologies required for robust USV operation in real-world environments, with a focus on autonomous navigation, obstacle avoidance, and path planning. This work began in 2002 with the transition of supporting technologies developed under UGV programs funded by the US Army and Marine Corps. After early evaluation of the Science Applications International Corporation (SAIC) *Owl Mk III* platform,¹ the Code 717 Unmanned Systems Group developed two sophisticated USVs based upon a jet-drive *Sea Doo Challenger* and an outboard *Boston Whaler* (Figure 3). See *Unmanned Surface Vehicle* in the Project Summaries section, Volume 2.

¹ The *Owl* was developed by International Robotic Systems in 1983, followed by a new-design *Owl MK II* in 1992. In 1995, International Robotic Systems became NAVTEC, Inc., which later partnered with SAIC on the *Owl Mk III*.

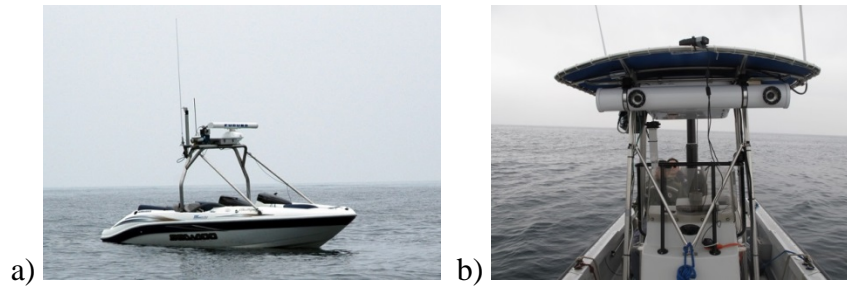

Figure 3. a) Our initial USV was based upon a jet-drive *Sea Doo Challenger* outfitted with GPS, video, lidar, and radar sensors. b) Similarly equipped, the second-generation USV was based on a *Boston Whaler* outboard drive.

UNMANNED UNDERSEA VEHICLES

The Space and Naval Warfare Systems Center Pacific has been developing and improving remotely-operated undersea vehicles since 1965. Early Center experience included development of the *Cable-controlled Underwater Recovery Vehicle (CURV)*,² the *Remote Unmanned Work System (RUWS)*, the *Mine Neutralization Vehicle (MNV)*, and the *Work Systems Package* (Morinaga & Hoffman, 1991). The development and testing of unmanned underwater vehicles (UUVs) today falls under the Unmanned Maritime Vehicle Lab headed by Rich Arrietta in the Maritime Systems Division (564), Bayside.

Since 1970, there has been significant collaboration between the undersea group and the Advanced Systems Division (Code 53)³ on a number of projects at the NOSC Hawaii Detachment at Kaneohe Marine Corps Air Station on Oahu. The *Advanced Tethered Vehicle (ATV)* follow-on to *RUWS*, for example, was a purpose-built UUV intended for operation at depths as great as 20,000 feet. Initiated in 1988, the *Teleoperator Telepresence System / Concept Verification Model (TOPS/CVM)* was a highly dexterous telerobotic master–slave work system that could mimic the manipulative dexterity of humans. Both these and other joint UUV efforts will be further discussed in the chronological Project Summaries section of this volume.

Other remotely operated and autonomous development efforts managed by the Unmanned Maritime Vehicle Lab included:

- *Advanced Unmanned Search System (AUSS)*
- *Distributed Surveillance Sensor Network (DSSN)*
- *Flying Plug*
- *Free Swimming Vehicle*
- *Submersible Cable-Actuated Teleoperator (SCAT)*
- *Snoopy*
- *Solid Rocket Booster Nozzle Plug (SRB/NP)*

See http://www.public.navy.mil/spawar/Pacific/Robotics/Pages/Underwater_Vehicles.aspx.

² *CURV* was used to recover the hydrogen bomb lost off Palomares, Spain, in 1966; the third-generation *CURV III* was used to attach a recovery line and pull the two-man crew of the bottomed *PISCES III* submersible to safety off Cork, Ireland in 1973 (Christ & Wernli, 2013).

³ The Advanced Systems Division (Code 53) was the forerunner of the current Advanced Systems and Applied Sciences Division, Code 71700.

BACKGROUND AND MISSION

With over 35 years of hands-on experience, the Code 717 Unmanned Systems Group at SSC Pacific has developed core in-house expertise in unmanned-vehicle technologies and attained a recognized leadership role in their design, development, fielding, and support. As depicted in Figure 4, the Unmanned Systems Group's fundamental role is to serve as an enabling interface between the development and DoD user communities of unmanned systems. From primary involvement with United States Marine Corps (USMC) and Army unmanned ground vehicles some 30 years ago, the Center has since led numerous S&T efforts for DoD with original research, applied research, and technology application on a wide variety of robotic platforms and missions. Within the last 10 years, the number and types of systems have increased greatly in all operational domains of air, land, and sea.

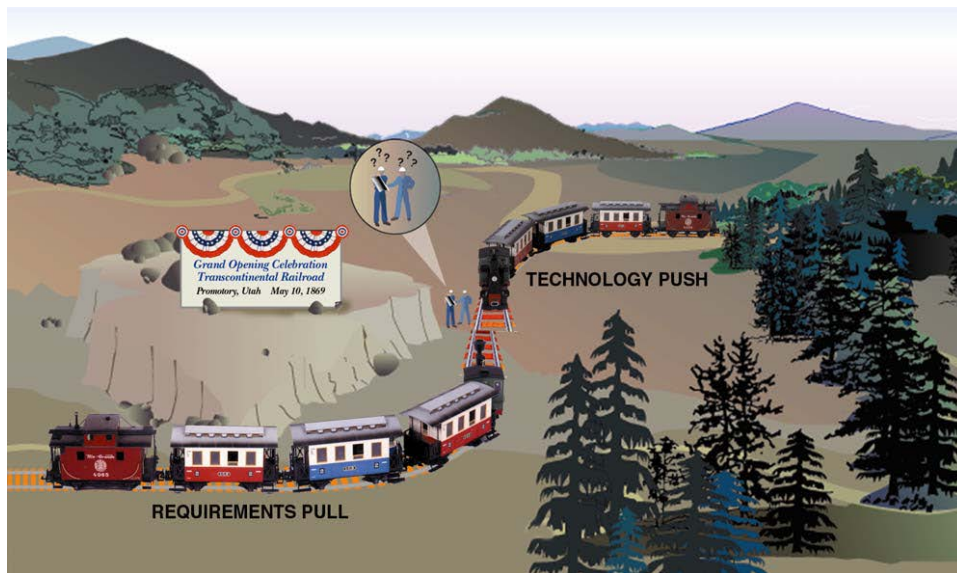

Figure 4. The primary role of the Code 717 Unmanned Systems Group at SSC Pacific is to serve as the “impedance-matching transformer” between unmanned-systems users and the supporting technical communities, two codependent groups that typically do not speak the same language.

Complementing the unmanned-vehicle development work (air, land, and sea), we are equally immersed in all aspects of the associated command, control, and communication needs, as will be further discussed under various efforts in the Project Summaries section. In addition to development, rapid prototyping, and testing, the Code 717 Unmanned Systems Group also provides quick-response incident and in-theater support when needed:

- Immediately after 9/11, we were tasked by the Robotic Systems Joint Program Office (RS JPO) to deploy a robotic search-and-rescue team to the World Trade Center.
- Just 6 months later, we provided three in-house-developed man-portable robots to Navy EOD Mobile Unit 3 for deployment to Afghanistan during *Operation Enduring Freedom*.
- Developed that same year (2002) for the US Army Chemical School, the prototype *Chemical and Hazardous Avoidance Robotic System (CHARS)* payload was ported to four iRobot *PackBot Explorers* provided via the RS JPO to the 82nd Airborne Division during *Operation Iraqi Freedom* in 2003.

- From 2004 to 2007, the Center deployed two-man Unmanned Systems Reserve Unit teams on recurring 6-month rotations to staff up the RS JPO Joint Robotics Repair Facility in Camp Victory, Iraq.

ORGANIZATIONAL STRUCTURE

The Center’s fledgling unmanned systems program reached critical mass in 1986 through the synergistic confluence of three geographically dispersed groups:

- The NAVSEA Office of Robotics and Autonomous Systems (SEA 90G), Naval Sea Systems Command, Washington, DC
- The Advanced Systems Division (Code 53), Naval Ocean Systems Center (NOSC), San Diego, CA
- The Autonomous Systems Branch (Code 442), NOSC Hawaii Laboratory, Kaneohe Marine Corps Air Station, Oahu, HI

The contributing roles played by each of these pioneering organizations are more fully described in the following subsections.

NAVSEA Office of Robotics and Autonomous Systems (SEA-90G)

In summer 1982, Vice Admiral Earl B. Fowler, Commander, Naval Sea Systems Command (NAVSEA), established a billet for the Special Assistant for Robotics within the NAVSEA Acquisition, Planning and Appraisal Directorate (SEA 90). Following completion of his thesis at the Naval Postgraduate School in Monterey, CA (Figure 5), engineering duty officer (EDO) Lieutenant Commander H.R. (Bart) Everett was assigned to this billet in November that same year as SEA 90M3 (Appendix A). The overarching intent was to identify and coordinate all NAVSEA efforts in robotics to minimize redundancy, ensure compatibility of independently developed systems, and avoid the risks of inappropriately assigned or ill-conceived applications (Everett, 1984).



Figure 5. *ROBERT I* (lower left), Lieutenant Commander Bart Everett’s thesis project at the Naval Postgraduate School in Monterey, CA, triggered a media frenzy that led to Everett’s 1982 assignment as Special Assistant for Robotics to Vice Admiral Earl Fowler, Commander, Naval Sea Systems Command (Appendix C).

To facilitate this endeavor, Lieutenant Commander Everett recruited a diverse team from two sources: 1) NAVSEA program managers interested in the application of robotic technology, and 2) evolving subject matter experts from the supporting Navy Laboratories. What would later be referred to as an Integrated Product Team (IPT), this group came to be known at the time as the NAVSEA Robotics Council. As the NAVSEA *Integrated Robotics Program* grew in scope (Figure 6), the Office of Robotics and Autonomous Systems (SEA 90G) was officially stood up under Lieutenant Commander Everett in May 1984 (Appendix B), with 70 ongoing efforts catalogued by end of the following year (Everett, 1985a). In recognition of the increased oversight requirements, former naval officer William Butler was hired to assist as SEA 90G1.

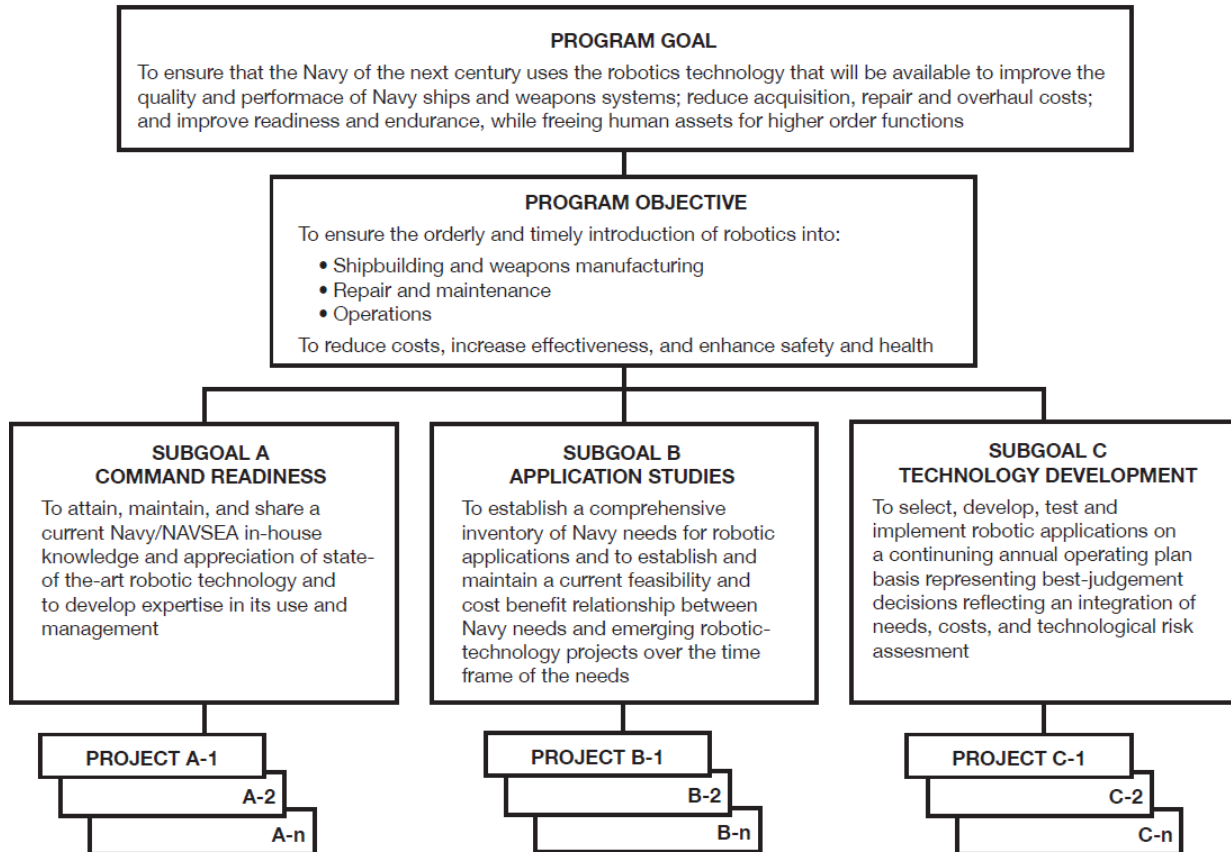

Figure 6. Program goals and objectives for the NAVSEA Integrated Robotics Program managed by the Office of Robotics and Autonomous Systems (SEA 90G), Naval Sea Systems Command, Washington, DC (adapted from Everett, 1985a).

To provide corporate awareness of all DoD development efforts, the NAVSEA *Robotics and Artificial Intelligence Database (RAID)* was established by SEA 90G (Figure 7), to be maintained by Code 9302 at NOSC in San Diego, CA. Accessible to approved DoD users via the ARPANET after coming online in 1984,⁴ this database supported three broad categories of information:

- The Project Information section identified the principal investigator, sponsor, technical synopsis, and location of the performing research/development activity.

⁴ Created by the DoD Advanced Research Projects Agency (ARPA), now the Defense Advanced Research Projects Agency (DARPA), the ARPANET was the precursor to today's internet.

- The Contacts Information section included the mailing addresses, phone numbers, special interest areas, and e-mail addresses of people and organizations in the field.
- The Bibliographic References section contained authors, titles, and short abstracts of pertinent literature from Department of Defense (DoD), industry, and academia.

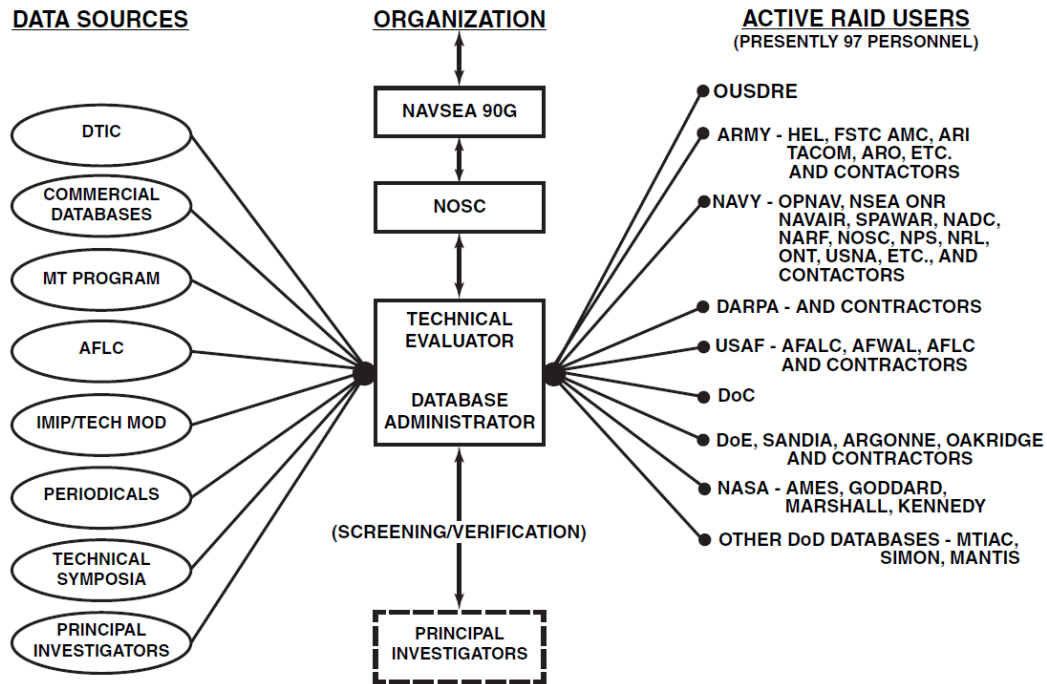

Figure 7. RAID was installed on a VAX-11/780 computer at NOSC, chosen for this role by SEA 90G because of its experience in robotics, telecommunications, and database management (adapted from Everett, 1985a).

Over 700 projects had been entered in RAID by the close of 1985, with 97 registered users from some 50 organizations (Everett, 1985a). By this point, SEA 90G had developed a structured assessment methodology that was employed by the NAVSEA Robotics Council to break down targeted application areas into associated technology needs, which were catalogued as follows:

- Those component technologies known to exist.
- Ongoing technology developments likely to become available in the near term.
- Unaddressed technology needs relatively unique to the project application.

The RAID database provided the enabling mechanism for this assessment and subsequent documentation of the results.⁵

A secondary benefit of this process was the inherent generation of a comprehensive listing of identified technology shortfalls common to multiple ongoing NAVSEA efforts (Everett, 1985b). These findings were coordinated with and endorsed by Dr. Randy Shumaker, Director of the Navy Center for Applied Research in Artificial Intelligence (NCARAI), part of the Information Technology Division within the Naval Research Laboratory. Joint NAVSEA/NCARAI recommendations to address these concerns were subsequently briefed to the Office of Naval

⁵ Following Everett's transfer to NOSC in 1986, oversight of the RAID database was handed off to Rome Air Development Center, NY, where it eventually languished and was ultimately abandoned.

Research (ONR) and Office of Naval Technology (ONT) on 6 September 1985 (Appendix B). At the suggestion of Vice Admiral Fowler, NOSC began a focused initiative to further mitigate these technology-base deficiencies, with Lieutenant Commander Everett flag-detailed to the Center to oversee this effort in November 1986 (Appendix D).

Prior to his transfer to San Diego, Everett was visited by Dr. Will Rasmussen (Code 44) and Dr. Doug Gage of NOSC, who recruited him into the Autonomous Systems Branch (Code 442). In a follow-up visit, Dr. John Silva (who headed the Center's Independent Exploratory Development (IED) program (Code 014), offered to fund a 3-year IED project entitled *Modeling the Environment of a Mobile Security Robot*, provided that *ROBART II* be made available as a supporting laboratory surrogate.⁶ This small in-house effort served as the springboard for ultimately establishing the Autonomous Systems Branch (reorganized as Code 535) at NOSC as the foremost DoD subject matter experts in robotics for physical security (Babb, 1990).

NOSC Autonomous Systems Branch (Code 442)

The Naval Ocean Systems Center in San Diego, CA, was one of four Navy Laboratories supporting the NAVSEA Office of Robotics and Autonomous Systems (SEA 90G) in the mid-1980s timeframe. As previously mentioned, Code 9302 at NOSC oversaw implementation, data entry, and technical management of the NAVSEA *Robotics and Artificial Intelligence Database (RAID)*. The Autonomous Systems Branch (Code 442), which supported SEA 90G via the NAVSEA Robotics Council, was developing a weld process-control expert system. This work was funded by the Manufacturing Technology Program, Naval Material Command (NAVMAT), as part of the SEA-070A *Integrated Flexible Welding System (IFWS)* project (Everett, 1985c).

Code 442 was also funded by the USMC Exploratory Development (6.2) Surveillance Program to develop the *Ground Surveillance Robot (GSR)* shown in Figure 8 (Harmon, 1984). The *GSR* project explored the design of a modular, flexible, distributed architecture for the integration and control of complex robotic systems, using a fully actuated 7-ton *M-114 Command and Reconnaissance Carrier* as the testbed host vehicle. With an array of ultrasonic sensors (fixed and steerable) and a distributed blackboard architecture implemented on multiple PCs, the vehicle successfully demonstrated autonomous following of both a lead vehicle and a walking human in 1986 (Harmon, 1987). Shortly after Everett's arrival in San Diego, the Autonomous Systems Branch (Code 442) was reorganized under Code 53 as the Autonomous Systems Branch (Code 531).

⁶ *ROBART II* was a second-generation security robot constructed by Everett in the basement of his home in Springfield, VA, as follow-on to *ROBART I*, his thesis project at the Naval Postgraduate School (NPS) in Monterey, CA. Both of these systems are further discussed in the Project Summaries section of this volume.



Figure 8. The Code 442 autonomous Ground Surveillance Robot (GSR) was based upon an *M-114 Command and Reconnaissance Carrier*. At right is *ROBART II*, newly arrived from Springfield, VA, circa December 1986.

Advanced Systems Division (Code 53)

Located on the northeast shore of Oahu (Figure 9), the Advanced Systems Division (Code 53) of the NOSC Hawaii Laboratory played an early role in the development of unmanned systems for Navy and USMC customers (Table 1). Initial pursuit of underwater applications such as the *Remote Unmanned Work System (RUWS)* began in the early 1970s (see later discussion under chronological Project Summaries). In both the undersea and ground robotics domains, a key focus became teleoperated remote-presence systems (binaural audio and stereo-vision feedback via helmet-mounted displays) for reducing the control burden imposed upon human operators.



Figure 9. The NOSC Hawaii Lab (lower left) was scenically situated just south of the threshold of Runway 22 at Marine Corps Air Station Kaneohe (now Marine Corps Base Hawaii) on the northeast side of Oahu, HI.

Table 1. Code 53 branches and branch heads at the NOSC Hawaii Lab as of January 1988. Code 535, the Advanced Technology Development Branch, was stood up and located in San Diego.

Code	Branch Name	Branch Head
531	Electrical Systems Branch	D.C. Smith
532	Mechanical and Teleoperator Branch	T.W. Hughes
533	Cognitive Sciences Branch	J.K. Katayama
534	Advanced Fiber Optic Systems Branch	A.T. Nakagawa

Early investigation and development of this technology began in the late 1970s (Figure 10a), continuing under the *Remote Presence Demonstration System (RPDS)* project in 1983 using the anthropomorphic master–slave configuration shown in Figure 10b. An instrumented exoskeleton worn by the operator generated servo-commands that caused the hydraulically actuated “Green Man” slave to replicate the same motions (Figure 11a). This master–slave control strategy would also mimic head movements, with two cameras attached to the robot’s head providing stereo imagery to a pair of video-camera eyepiece monitors mounted on an aviator's helmet worn by the operator.

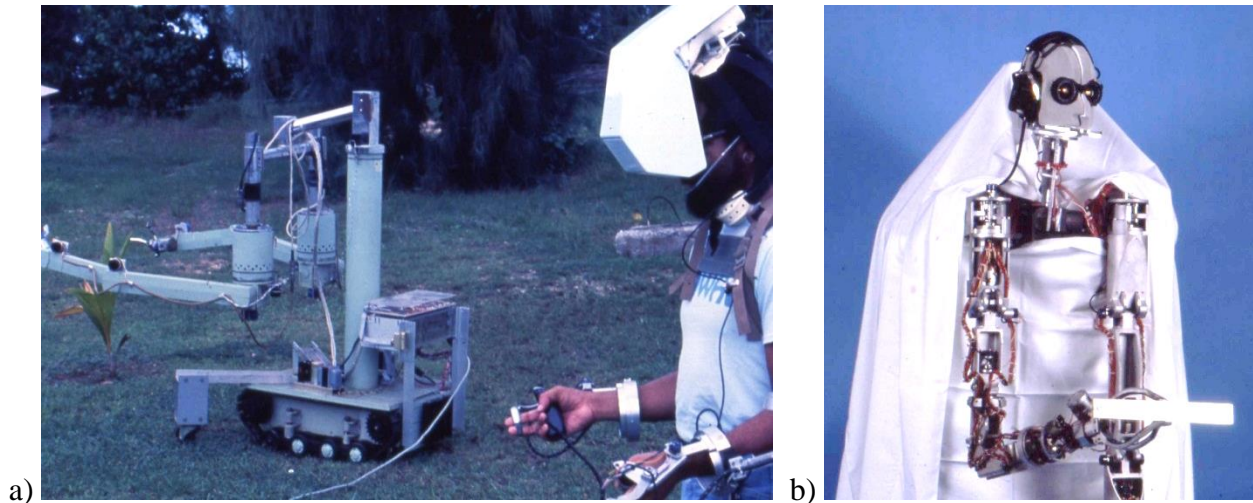

Figure 10. a) This early-70s telepresence demonstration platform was based upon a small tracked ground robot (bottom left), with a preliminary helmet-mounted stereo display worn by the operator. b) This anthropomorphic “Green Man” configuration, circa 1981, was outfitted with hydraulic arms, manipulators, and a moveable head.

This evolving remote-presence technology was especially relevant to certain ground applications of interest to the US Marine Corps. The *RPDS* prototype shown in Figure 11b was constructed by the Hawaii Lab to demonstrate how such a system could provide natural and intuitive control of teleoperated ground vehicles. Hosting an articulated dual-camera system with an associated helmet-mounted display, this small surrogate vehicle provided the operator with both stereo vision and binaural hearing, the pan-tilt actuators being slaved to the operator’s head motion and vehicle steering controls. There was also a microphone/speaker system to project the operator’s voice from an on-board speaker via the multi-conductor electrical tether (Umeda, 2015).

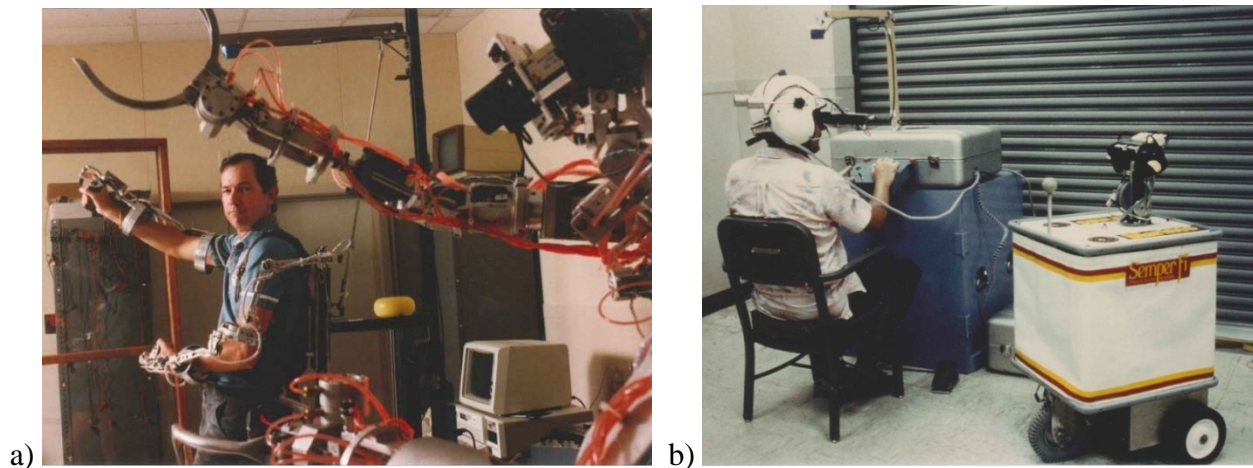

Figure 11. a) Kirk Jennings operates an improved “Green Man” master–slave system developed under the Remote Presence Demonstration System (RPDS) project. b). The elevated ball atop the front of this small indoor robot operated by Dave Smith provided a vehicle-based visual reference for the stereo camera pair, circa 1982.

In the early 1980s, two reconnaissance, surveillance, and target-acquisition (RSTA) projects were undertaken by NOSC under the auspices of the US Marine Corps Exploratory Development (6.2) Surveillance Program: 1) the *Advanced Teleoperator Technology (ATT)* effort by Codes 531 and 532 at the Hawaii Lab; and, 2) the previously mentioned *Ground Surveillance Robot (GSR)* by Code 442 in San Diego. Under the first of these, the remote-presence technology originally developed for the NAVSEA *RUWS* project was ported to a teleoperated dune buggy. A parallel air-vehicle concept involved the vertical-take-off *Airborne Remotely Operated Device (AROD)*, initially based on a quadrotor manufactured by Moller International (Figure 12).



Figure 12. The tethered *Airborne Remotely Operated Device (AROD)* was an electrically powered quadrotor developed by Moller International and tested as an airborne remote-presence system at the NOSC HI Lab.

The operator control station for the dune-buggy portion of the *ATT* thrust employed a mechanical tracking capability to measure the position and orientation of the driver's helmet (Figure 13a), which was later replaced by a non-contact inductive system (Figure 13b). This 3D-pose data was used to control the robotic pan-and-tilt unit in the driver's seat of the dune buggy (Figure 13c), which consequently mimicked the head motions of the operator. A stereo-camera pair mounted atop this pan-and-tilt unit thus looked in the same direction and elevation as the remote operator at the control station. As the focus was on high-quality telepresence to facilitate remote driving under degraded visual conditions, a fiber-optic tether was used to provide high-bandwidth communications with minimal latency.⁷

⁷ Support for this component was provided by the Advanced Fiber Optic Systems Branch (Code 534).

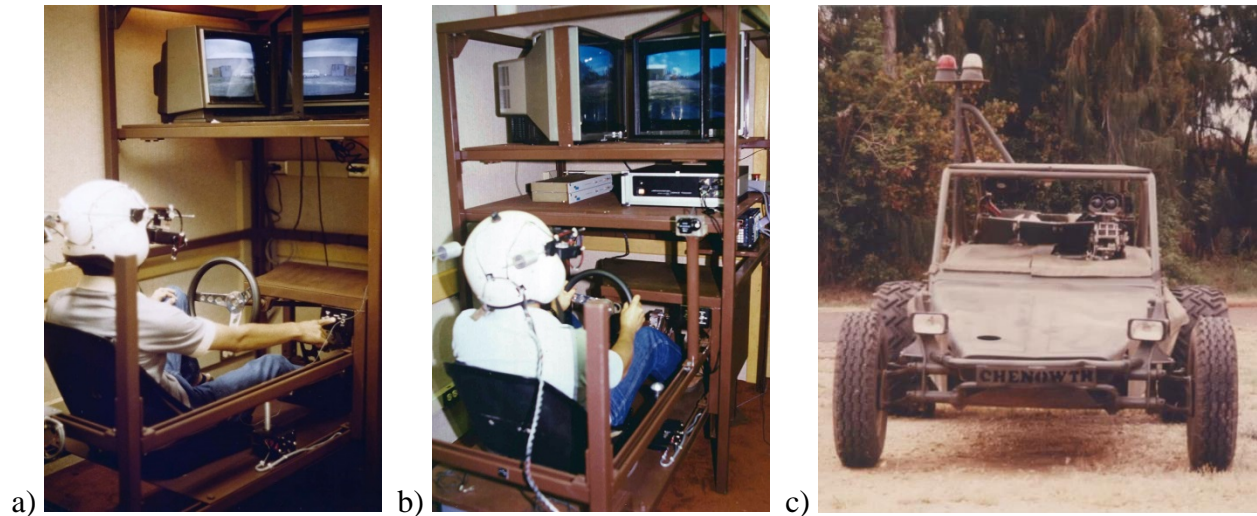

Figure 13. a) A mechanical tracking system (out of image left) attached to the white helmet measured the orientation of the operator's head. b) A Polhemus 3D tracking system has replaced the mechanical version. The displays at upper right provided visitors wearing polarized glasses with stereo vision. c) The robot's head mimicked the pose of the operator's helmet while its cameras relayed stereoscopic video to the helmet-mounted display.

A secondary project goal was to demonstrate practical applications of fiber optics in general, and Code 534's ability to design bidirectional telemetry systems with data rates up to 200 megabits per second. Challenges in this UGV application included the necessary development of cable winding (Figure 14), payout, and recovery systems, as well as maintaining reliable communications in high-vibration environments. With regard to this latter issue, a custom-fabricated fiber-optic cable for UGV applications, ruggedized with a polyurethane and Kevlar jacket, was designed and ordered for improved survivability under dynamic real-world conditions.⁸



Figure 14. Warren Hahn and Clifford Horikawa of the NOSC Hawaii Laboratory prepare a new spool of fiber-optic cable (image center) with a custom designed winding machine for this purpose. Effective cable winding, payout, and recovery were essential for reliable teleoperation in the field.

⁸ The NOSC Hawaii Lab began using fiber-optic tethers on UUVs in the late 1970s (Nakagawa & Smith, 1980).

The exploratory remote-presence development conducted on the dune-buggy UGVs ultimately transitioned to the USMC *HMMWV*-based *Ground/Air TeleRobotic System (GATERS)* prototype shown in Figure 15. A Polhemus 3D tracker replaced the mechanical version employed earlier under the dune-buggy effort to measure the human driver's head movements in real time. The 3-axis inductive sensor component mounted on the L-shaped support above the portable operator control station tracked the orientation of a 3-axis inductor mounted on top of the driver's helmet. This non-invasive approach was more accurate and far less disconcerting to the human operator.



Figure 15. This early version of the *GATERS* UGV, shown prior to installation of the Surveillance and Weapon Modules, employed a Polhemus 3D tracking system (see blue sensor on L-shaped support above operator's helmet below). The equipment at lower right comprised a portable operator control station.

An embedded version of the operator control station is shown in Figure 16a, with the blue Polhemus sensor attached to a wooden support above the driver's head. *GATERS* team members (from left to right) Scott McArthur, Tony Koyamatsu, Captain George Murray (USMC), Derrick Kusuda, Tom Hughes, Celia Metz (unknown); Tracy Heath (unknown), and Alan Umeda pose with the UGV in Figure 16b. Just left of Captain Murray, the stereo cameras on the robotic head have been enclosed in a watertight fiberglass enclosure for more rugged outdoor testing in San Diego, as further discussed under the Project Summaries section in this volume.

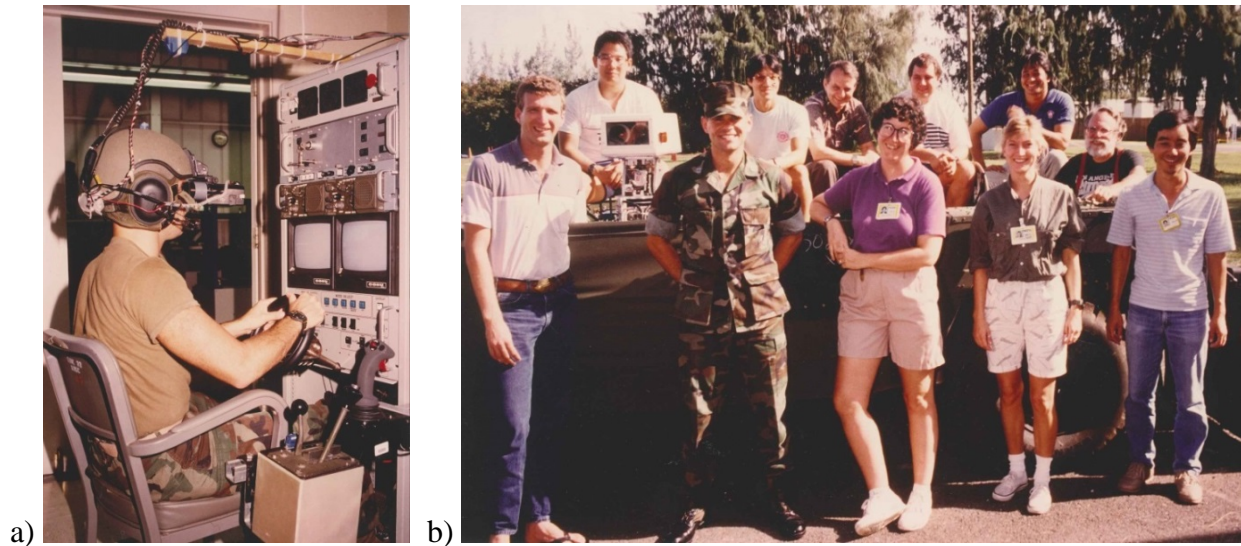

Figure 16. a) Early *GATERS* control station employing helmet-mounted display. b) The *GATERS* UGV (background) was a descendent of the exploratory ATT dune buggy. Celia Metz (foreground center) was later selected as Code 53 Division Head, while Tracy Heath to her left would become the Code 71710 branch head in 2013.

The *GATERS* project, renamed the *Teleoperated Vehicle Project (TOV)* project, transitioned in 1988 to Code 535 in San Diego for system hardening and support during field evaluation by the Marine Corps Tactical Systems Support Activity (MCTSSA), Camp Pendleton, CA. Hawaii Codes 531, 532, and 534 continued to provide valuable technical assistance during this effort through 1989. Closure of the NOSC Hawaii Laboratory, which had been recommended under the *Base Closure and Realignment Act of 1990*, was unfortunately approved in 1991. Several of the Code 53 projects briefly mentioned in this section are discussed in greater detail in the Project Summaries section.

NOSC Autonomous Systems Branch (Code 535)

Seriously outshaded by the Defense Advanced Research Projects Agency (DARPA) *Autonomous Land Vehicle (ALV)* program,⁹ all further work on the *Ground Surveillance Robot (GSR)* was cancelled by the USMC in 1986, whereupon the *M-114*-based vehicle became an air-to-ground target on San Clemente Island. When Lieutenant Commander Everett reported aboard NOSC in November of that year, much of Code 442 had already left to work in other branches or the private sector (Figure 17). Down to just five members, the Autonomous Systems Branch (Code 442) was soon reorganized under the Advanced Systems Division (Code 53) as Code 535.¹⁰

The new business strategy was to springboard off the highly successful Independent Exploratory Development *ROBART II* project to attract outside sponsors (Babb, 1990). Commander Everett was subsequently contacted by the Armament Research Development and Engineering Center (ARDEC) at Piccatinny Arsenal regarding their new-start effort for the U.S. Army Physical Security Equipment Management Office (PSEMO) at Fort Belvoir,¹¹ the *Mobile Detection Assessment Response System (MDARS)*.

⁹ The *ALV* project was part of DARPA's *Strategic Computing Initiative*, which began in 1983 (DARPA, 1986).

¹⁰ Lieutenant Commander Everett was offered the position of Officer in Charge of the NOSC Hawaii Lab by Code 53 Division Head Don Moore, but opted to remain in San Diego and pursue his NAVSEA tasking.

¹¹ Now Product Manager, Force Protection Systems (PdM-FPS) at Fort Belvoir, VA.



Figure 17. Code 442 personnel in March 1987, clockwise from upper left: Will Gex, Gary Gilbreath, Guy Bianchini, Walt Aviles, Robin Laird, Manuel Solorzano, Telford Quon, Nancy Campbell, Margaret Myers, Lieutenant Commander Bart Everett, Brian Pinz, and Doug Gage. Seven of the above personnel would leave over the next several months.

In 1989, PSEMO began funding the Branch to support a number of robotic-security programs that continued to evolve over the next 25 years (Babb, 1990). As this role expanded, Commander Everett eventually became the overall *MDARS* Technical Director in 1993, retiring from active duty in September of that same year. Following a Federal hiring freeze, Everett was rehired as Associate Division Head for Robotics (Code 5305) under Division Head Doug Murphy (Code 53) in January 1994.

In 1996, the Adaptive Systems Branch (Code 531) was redesignated as the Autonomous Systems Branch (Code D371), Advanced Systems Division (Code D37), Space and Naval Warfare Systems Center San Diego (see Appendix B). With the retirement of Doug Murphy in 1999, Celia Metz took over as Code D37 Division Head. Our primary focus during this timeframe was on the *MDARS Interior* and *Exterior* programs, plus a new start *Man Portable Robotic System (MPRS)* project funded by NAVSEA. In 2001, at the request of the RS JPO in Huntsville, AL, three *Urban Robots (URBOTs)* developed under the *MPRS* project were sent to the WTC site to assist in search and rescue operations (Figure 18).



Figure 18. Bart Everett (Code D3705 Associate Division Head for Robotics) and Robin Laird (Code D371 Branch Head) with nine shipping containers containing three *URBOTS* and associated support equipment on the ground at Stewart Air National Guard Base in Newburg, New York. (See *Man Portable Robotic System* in Project Summaries section.)

The Adaptive Systems Branch (Code D371) was reorganized as the Robotic Systems Branch (Code 2371) in early 2002, with now over ten funded projects in the air, land, and sea domains (Figure 19). The *MDARS Interior* program was undergoing Limited User Testing (LUT) at Susquehanna Army Depot, PA, while the parallel *Exterior* program had entered the System Development and Demonstration phase. The *Unmanned Surface Vehicle (USV)* project had just kicked off as an *MDARS* spinoff, with preliminary evaluation of the radio-controlled SAIC *Owl Mk III* jet-ski. A Cooperative Research and Development Agreement (CRADA) had been signed with Allied Aerospace to integrate their VTOL *iStar* UAV with an *MDARS* (BAA) robot.



Figure 19. Members of the Robotic Systems Branch pose next to newly erected Building 618 in the F-36 parking lot with representative robots from seven of its ten ongoing projects, circa March 2002. Note the 29-inch *iStar* UAV between the SAIC *Owl Mk III* (foreground center) and the *MDARS* BAA ground robot (foreground right).

On 19 July 2002, former Speaker of the House Newt Gingrich visited the Center on a fact-finding mission for Secretary of Defense Donald Rumsfeld, and spent considerable time with the Robotic Systems Branch (Code 2371). His objective was to investigate promising technologies that could potentially lead to significant operational advantages for warfighters in theater. One of the first demonstrations along these lines was the *MPRS URBOT*, which had deployed to both the World Trade Center (Mullens, 2001) and *Operation Enduring Freedom* (Mullens, 2002a), with special focus on the new marsupial-carrier payload for traditional and unmanned vehicles (Figure 20).



Figure 20. Bart Everett explains the *MDARS* (BAA version) less-lethal pepper-ball gun pod (upper left) and rear-mounted UGV marsupial carrier for the man-portable *URBOT* to Mr. Gingrich in the F-36 parking lot Seaside.

Another key event was a free-flight demonstration of the Allied Aerospace (formerly Micro Craft) *iSTAR* 29-inch lift-augmented ducted-fan UAV at Code 2371's Central Test Site on Woodward Road (Figure 21a). On 14 March 2002, the first known launch of a VTOL UAV from a host UGV had been conducted under a CRADA with Allied Aerospace at the Holtville Regional Airport just east of El Centro, CA (Mullens, 2002b). Under the new-start *Autonomous UAV Mission System (AUMS)* project, the *MDARS* UGV would soon be equipped with a payload for autonomous, launch, recovery, and refueling of VTOL UAVS, as further discussed under Project Summaries in Volume 2 (Mullens, 2002c).

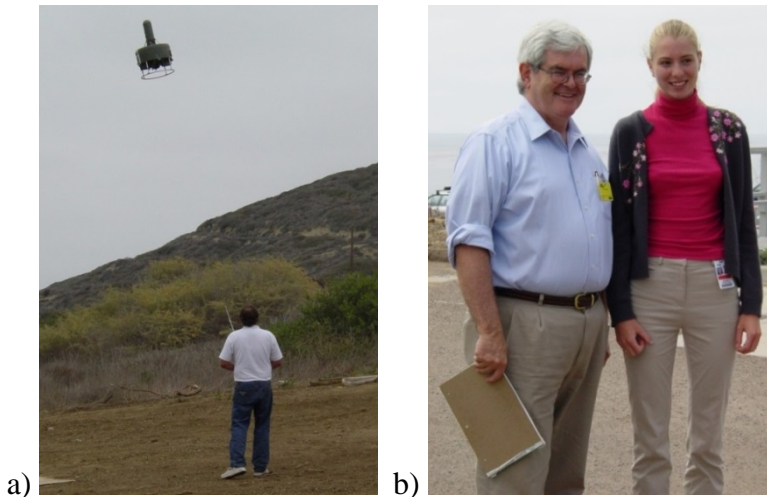

Figure 21. a) A free-flight demonstration of the Allied Aerospace *iStar* UAV. b) ONR summer intern Rachel TenWolde talks with Newt Gingrich during his visit to the Robotic Systems Branch in September 2002. A Lean-Six-Sigma Black Belt, Ms. TenWolde was hired in 2008 and selected as the Code 71720 Branch Head in 2013.

During his visit, Mr. Gingrich expressed considerable interest in countermine and humanitarian-demining applications of ground robots (Figure 22). Beginning in 1994, the Center had played a supporting role in the *Basic UXO Gathering System (BUGS)* project managed by the Naval EOD Technology Division (Gage, 1995a). The *BUGS* objective was to design, test, evaluate, and demonstrate the use of distributed robotics in clearing unexploded submunitions and minefield neutralization (DeBolt, O'Donnell, Freed, & Nguyen, 1997). With help from a number of established EOD players in the field, Bart Everett prepared a comprehensive discussion of robotic countermine opportunities, which was hand delivered to Mr. Gingrich in Washington, DC, by Commanding Officer Captain Tim Flynn.

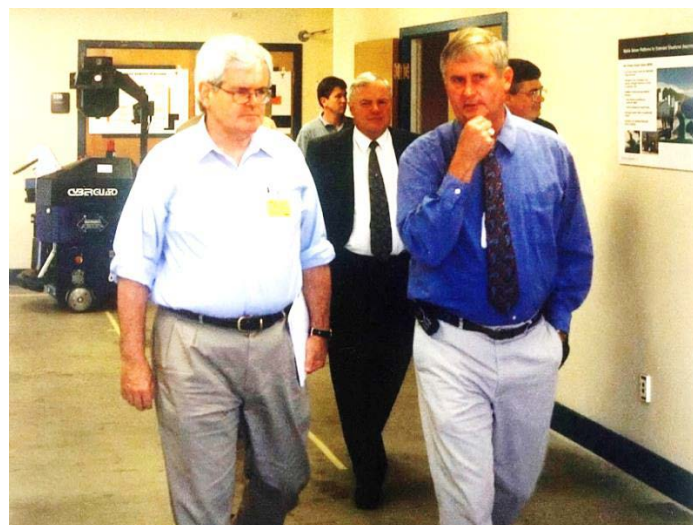

Figure 22. Newt Gingrich confers with Bart Everett regarding countermine strategies that could potentially be addressed by robotic systems. Code 2371 would later be involved in a number of mine detection, marking, excavation, and neutralization efforts, as further discussed in the Project Summaries sections of Volumes 2 and 3.

Following the 11 September 2001 terrorist attack on the World Trade Center, Code 2371 focused on expediting the spiral development of warfighter needs in the technical community, including academia, industry, and DoD/government entities. By 2002, the emphasis was on man-portable robots used in counter-IED missions, resulting in the branch's designation as a "Center of Excellence for Small Robots" in the OSD *Joint Robotics Program Master Plan* (JRP, 2002). The highlight that year was a visit from Secretary of Defense Donald Rumsfeld on 26 August (Figure 23), prompted by a recommendation from Newt Gingrich.



Figure 23. Robin Laird (foreground left) and Bart Everett (foreground right) brief Secretary of Defense Donald Rumsfeld on Code 2371's support for *Operation Enduring Freedom* during his visit to the Center on 26 August 2002. Rear Admiral Ken Slaght, Space and Naval Warfare Systems Command (SPAWAR) commander, is at background left.

Some 17 robots were presented from eight different unmanned-ground-vehicle projects, with an emphasis on various systems developed for force-protection and tactical applications, particularly those used in *Operation Enduring Freedom*. Also demonstrated was the Center's *Urban Robot (URBOT)*, which deployed to Afghanistan with Navy Explosive Ordnance Disposal Mobile Unit 3 in April 2002 (see later *Man-Portable Robotic System* section). Assisting was Colonel Bruce Jette (Figure 24), who led the Robotic Tiger Team that performed a quick-response technology insertion in Afghanistan that summer, placing small-robot systems in the hands of warfighters engaged in life-threatening roles.



Figure 24. Colonel Bruce Jette (right), recently returned from Afghanistan and future head of the U.S. Army Rapid Equipping Force (REF), assisted in the presentation to Secretary of Defense Rumsfeld.

On 15 May 2002, Chief of Naval Operations Admiral Vern Clark and several members of his staff visited and were briefed on a number of key Center programs, then given an unmanned systems demonstration by Robin Laird, Code 2371 Branch Head (Figure 25a). The following week, the Honorable Hansford T. Johnson, acting secretary of the Navy, toured the Center, receiving an unmanned systems briefing from Bart Everett, Code 237's Associate Division Head for Robotics, followed by a demonstration of man-portable robots from the *Robotic Systems Pool* (Figure 25b). Considerable interest was expressed in several of the 19 projects then underway, with focused attention on support to Navy SEALs and Explosive Ordnance Disposal (EOD) units deployed in Iraq and Afghanistan (Mullens, 2003b).



a)



b)

Figure 25. a) Code 2371 Branch Head Robin Laird (right) and EM1 Thomas Hoover (left) demonstrate the *URBOT* for CNO Admiral Vern Clark on 15 May 2003. b) Associate Division Head for Robotics Bart Everett (center) and Branch Head Robin Laird (right) brief the Honorable Hansford T. Johnson, acting secretary of the Navy, the following week.

Rear Admiral Albert “Bert” Calland, Commander, Naval Special Warfare Command (NSWC) briefed senior management and other interested parties on Special Operations during *Operation Enduring Freedom* in Afghanistan on 28 May 2003 (Figure 29). Admiral Calland and his staff were presented various briefings by Center personnel, with a focus on intelligence, surveillance and reconnaissance (ISR) information supporting special operations. An important part of the latter included a visit to the Robotic Systems Branch for live demonstrations of unmanned systems for surface, ground, air, and underwater vehicle applications (Mullens, 2003b).



Figure 26. SPAWAR Commander Rear Admiral Ken Slaght (center), and Executive Director Dr. Bob Kolb (right), host Rear Admiral Bert Calland, Naval Special Warfare Command (left), during his visit to the Center on 28 May 2003.

Beginning in 2004, the Robotic Systems Branch deployed several active-duty officers and Reservists to Iraq and Afghanistan to support UGV operations by Joint Forces EOD units (Figure 27), to include establishment of the *Joint Robotics Repair Facility* for the RS JPO at Camp Victory, Iraq (see also *Navy Unmanned Systems Reserve Unit* section, Volume 2). This assignment turned out to be a wonderful opportunity to gather valuable user feedback, which is often hard to obtain. That same year, the Robotic Systems Branch (Code 2371) was renamed the Unmanned Systems Branch, which was later redesignated as Code 7171 in 2007 (Appendix E).



Figure 27. IT2 Jennifer Smith and AT1 Jim Overton of the SPAWAR Unmanned Systems Reserve Unit are recognized by the 184th Ordnance Battalion (EOD) for their services at Camp Victory (October 2004 through April 2005).

On 24 February 2005, Brigadier General Stephen Reeves (U.S. Army), Joint Program Executive Officer for Chemical and Biological Defense (PEOCBD), visited the Unmanned Systems Branch to become familiar with Code 2371's technical capabilities (Figure 28). He was accompanied by Colonel Camille Nichols, program manager for Guardian (PM Guardian). She had visited the our lab the previous fall (Thomas, 2004). Brigadier General Reeves and Colonel Nichols were given status updates on two key Army programs the Center was supporting for the Product Manager, Force Protection Systems (PM-FPS): the *Mobile Detection Assessment Response System* and the *Family of Integrated Rapid Response Equipment* (Mullens, 2005).



Figure 28. Bart Everett (right) describes the operation of the marsupial payload mounted on the back of an *MDARS Exterior* robot (BAA version) to Brigadier General Reeves (center) as a man-portable *URBOT* is recovered for transport. Navigation and Applied Sciences Department Head Dr. Frank Gordon is at background right.

On 11 May 2005, SPAWAR Commander Rear Admiral Kenneth Slaght hosted a visit to the Unmanned Systems Group for SPECWARCOM Deputy Commander Captain John McTighe, and his science advisor, John Young (Mullens, 2005). The purpose of this visit was to view the innovative stabilization technology of Motion Picture Marine of Marina del Rey, CA. In 2003, SSC San Diego acquired one of the company's *Perfect Horizon* stabilization systems for incorporation on our *Unmanned Surface Vehicle (USV)* project, which has since been in use stabilizing camera/sensor systems aboard the USV in both pitch and roll. The Navy SEALs were interested in stabilization of camera sensor systems and potentially also weapons (Figure 29).



Figure 29. Mike Bruch (foreground right) explains the Perfect Horizon active-stabilization mount for a 0.50-caliber *M2* machine gun to SPAWAR Commander Rear Admiral Ken Slaght (background right), and Captain John McTighe, deputy commander of Naval Special Warfare Command (background center). Captain John Barron, executive officer of Space and Naval Warfare Systems Center San Diego, is at background left.

On 19 November 2008, the Unmanned Systems Branch hosted a visit from Major General Robert G.F. Lee, adjutant general of the Department of Defense for the state of Hawaii, and Clifton Cheng of the Naval Undersea Warfare Center Detachment (Figure 30a). Following a high-level overview of the branch's history and mission by Bart Everett, Major General Lee received an in-depth presentation from Robin Laird on the *Joint Battlespace Command and Control System*, recently demonstrated at the *Force Protection Joint Experiment*. He was also briefed on the *Robotics Systems Pool* by John Andrews (Figure 30b), and the *Networked Remotely Operated Weapon System* project by electrical engineer Amin Rahimi.



Figure 30. a) Robin Laird (background center) briefs Major General Robert Lee (foreground right), on the *Joint Battlespace Command and Control System* used at the *Force Protection Joint Experiment*. b) John Andrews answers questions following his comprehensive overview of the *Robotic Systems Pool* managed by the Unmanned System Reserve Unit.

On October 27th, 2009, SPAWAR Commander Rear Admiral Michael Bachmann hosted a VIP visit to the Unmanned Systems Branch for J.M. “Raleigh” Durham of the Pentagon’s Director of Defense Research and Engineering (DDR&E). Following a high-level introductory overview by Bart Everett, selected branch projects related to vehicle autonomy and collaboration were presented by Branch Head Hoa Nguyen (Curd, 2009). The principal focus of Mr. Durham’s visit, however, was on live demonstrations of autonomous unmanned vehicles across all operational domains of air, land, and sea, with command and control provided by the *Multi-robot Operator Control Unit (MOCU)* software (Figure 31).



Figure 31. Estrellina Pacis (foreground right) briefs Rear Admiral Michael Bachman (center) and J.M. “Raleigh” Durham (background left) on the *Urban Environment Exploration (URBEE)* project in Building 624 on 27 October 2009, with *URBEE* software engineer Donnie Fellers overseeing the demonstration (foreground left).

On 10 June 2010, the Center hosted prospective SPAWAR Commander Rear Admiral Patrick H. Brady, who took command of the Space and Naval Warfare Systems Command in August that same year. One of the stops on his agenda included the Unmanned Systems Group, where he was briefed by Bart Everett on how unmanned systems fit the Center's role in command, control, and communications. The walk-through systems tour illustrated how some degree of vehicle autonomy facilitated command and control while reducing the communication bandwidth, and how the on-board sensors supporting such autonomy could significantly contribute to information warfare (Figure 32).



Figure 32. Bart Everett briefs prospective SPAWAR Commander Rear Admiral Patrick Brady on the commercial 3D stereo-camera pair and *Velodyne 64* lidar employed on the six-wheel *MAX ATV* (left), in contrast with the massive custom-built counterpart used on the earlier *MDARS-Exterior* vehicle in background.

As more and more employees were brought on board to meet the expanding project load, a split into two branches was required in 2012 under the Code 717 Advanced Systems and Applied Sciences Division: Code 71710 under Branch Head Tracy Heath, and Code 71720 under Branch Head Rachel TenWolde. These two branches, which collectively came to be known as the Code 717 Unmanned Systems Group, remained high on the list of potential tour opportunities for Center visitors and VIPs. The most recent highlight in this regard was a visit from Secretary of Defense Ashton B. Carter on 3 February 2016 (Figure 33).

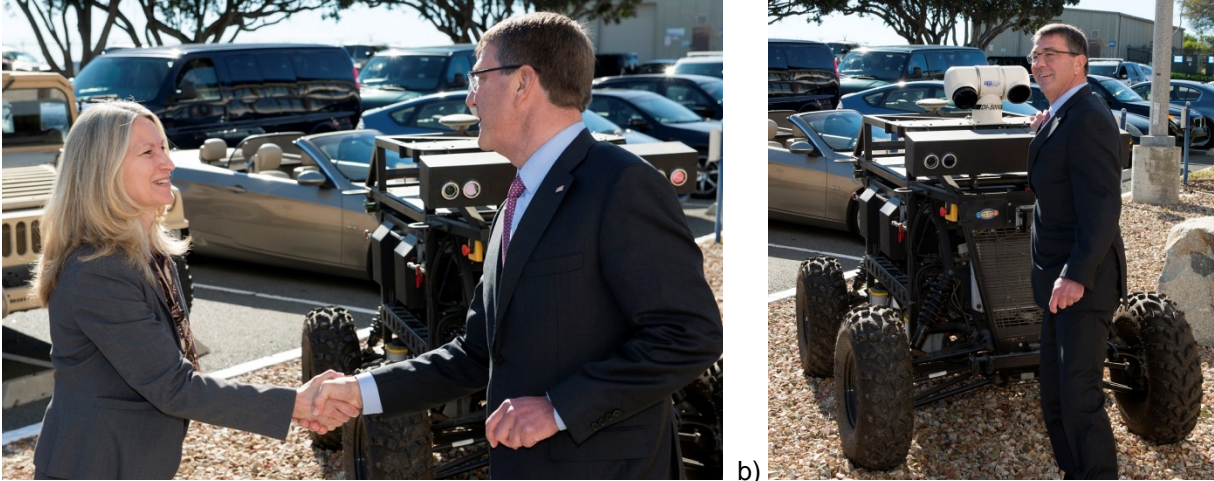

Figure 33. a) Code 71710 Branch Head Tracy Heath-Pastore greets Secretary of Defense Ashton Carter during his visit on 3 February 2016. b) Secretary of Defense Carter coins a *Reconnaissance and Detection Expendable Rover (RaDER)* vehicle designed by SSC Pacific engineers to support U.S. Marine Corps battlefield operations.

Carter was visiting the Center to meet with SSC Pacific’s workforce, tour the Center’s *Battlespace Exploitation Mixed Reality (BEMR)* lab, and gain a deeper understanding of the many futuristic technologies and systems being developed to ensure America’s warfighters have a strategic and technological advantage. Following the visit, Tracy Heath-Pastore and Mike Bruch further briefed SPAWAR Commander Rear Admiral David H. Lewis on ONR-funded unmanned ground vehicle work (Figure 34), which represents state of the art in off-road and expeditionary autonomous navigation. (See further discussion of these efforts in the Project Summaries section of Volume 3.)



Figure 34. Code 717 Chief Engineer for Robotics Mike Bruch (center) holds the commemorative coin presented to the RaDER vehicle by SECDEF while describing the ONR-funded project to Rear Admiral David H. Lewis, the new SPAWAR commander, on 3 February 2016.

TECHNOLOGY FOCUS AREAS

The *Department of the Navy Objectives for FY 2012 and Beyond* contained the following paragraph (DoN, 2012):

- “5. Dominate in Unmanned Systems
 - a. Integrate Unmanned Systems into the DON Culture
 - b. Develop Unmanned Systems in the Air
 - c. Deploy and Establish Unmanned Systems on/under Sea
 - d. Field Unmanned Systems on the Ground”

Three years later, the *Department of the Navy Objectives for FY-15 and Beyond* reiterated this continuing objective as follows (DON, 2015):

- “5. Proliferate Unmanned Systems
 - a. Integrate Unmanned Systems into the DON Culture
 - b. Develop, Field, and Deploy Unmanned Systems in the Air, on/under the Sea, and on the Ground”

By this time, unmanned systems had increasingly been employed in various operations ranging from combat to disaster-relief across all operational domains of air, land, and sea, with growing appreciation of the results.

This wide variety of applications required configurable command, control, and communication (C3) systems designed to fit the assigned mission, capable of clearly displaying relevant mission-specific information to the warfighter. Across this spectrum of opportunity, we identified five common technology-focus areas that over time have evolved into core business units (Figure 35), greatly facilitating inter-project technology transfer and subsequent system interoperability. The degree of information dominance ultimately achieved by unmanned systems is a direct function of how these factors interrelate and are consequently exploited, as will be further discussed in the following subsections.



Figure 35. The degree of information dominance achieved by unmanned systems is directly influenced by many interrelated factors that must be well understood and properly integrated.

The Center’s mantra is command, control, and communications, and providing such for unmanned vehicles can be greatly facilitated if these systems have some degree of supervised autonomy, as opposed to just teleoperated. Enabling intelligent on-vehicle autonomy requires appropriate local perception, typically from radar, lidar, sonar, and/or vision-based sensors. A “smart” unmanned

system must effectively perceive its surroundings to make appropriate behavioral decisions, and in the early history of UGV development, this was the dominating theme. More recently, however, considerable attention has been given to exploiting on-board perception capability for purposes of intelligence, surveillance, and reconnaissance (ISR), through data mining and visualization. Each of these five business units will be further discussed in the following subsections.

Command, Control, and Communications

SSC Pacific's Unmanned Systems Group has developed command, control, and communication (C3) systems for unmanned vehicles and sensors for over 35 years, and is currently supporting acquisition programs in several services. The *Multiple Resource Host Architecture (MRHA)*, for example, provided C3 for the US Army Product Manager – Force Protection Systems (PdM–FPS) on the *Mobile Detection Assessment Response System (MDARS)* program of record. *MDARS* envisioned up to 32 interior and exterior security robots patrolling INCONUS Government sites, with a later force-protection variant of the concept evaluated for possible USMC deployment.

The *Multi-robot Operator Control Unit (MOCU)* evolved as a tactical derivative of the *MRHA* (Figure 36). Originally developed to support the *Man Portable Robot System (MPRS)* program for PMS-EOD, *MOCU* was later selected to provide C3 for the prototype USV mission modules on the Navy's *Littoral Combat Ship (LCS)*. The modularity of *MOCU* facilitated extension to meet the individual goals of multiple projects, with the inherent ability to quickly adapt to emergent needs. With over 70 *MOCU* modules developed by multiple partners, the software is able to control ground, surface, air, and underwater vehicles. The extremely flexible user interface features a game-like look and feel, with multiple users spanning the full range from academia to formal DoD programs of record.



Figure 36. Cathy Mullens (left) and Bart Everett (right) brief Dr. Dave Thomas of TARDEC on the Center's evolution of unmanned-vehicle command and control. The wall poster shows a timeline for *MRHA* expansion into *MOCU*, which by 2005 was already being used by a number of different organizations within industry and DoD.

Effective communication is obviously necessary to link the command-and-control architecture with the relevant assets, which could well include a mix of unmanned vehicles, conventional manned systems, and distributed sensors. During *Operations Iraqi Freedom* and *Enduring Freedom*, the

emphasis was on addressing the C3 needs of man-portable robots (Figure 37), which were deployed in large numbers to address the growing IED threat. The high-bandwidth RF communications links for these systems required line of sight, which presented numerous problems for teleoperation, especially for the small man-portable class of UGVs (Nguyen et al., 2013). Their inherent low antenna height causes signal occlusion due to dips and rises in the terrain, which can also significantly reduce the Fresnel-zone clearance, and operation in urban environments typical of Iraq only exacerbates the problem (Figure 37).

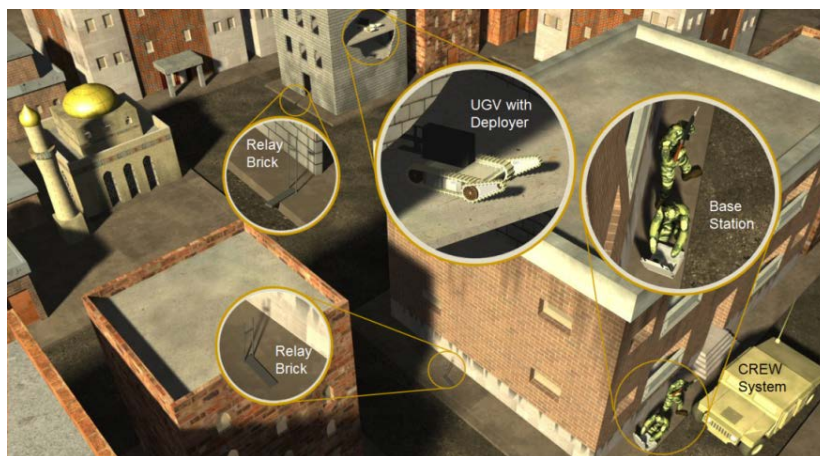

Figure 37. Joint Urgent Operational Needs Statement (JUONS) CC-0333 called for reliable communications between a *Man Transportable Robotic System (MTRS)* operating inside a building and its operator stationed outside. This critical need was addressed by the *Automatically Deployed Communication Relays (ADCR)* project in 2010.

In the early 2000s, the DARPA *Mobile Autonomous Robot Software (MARS)* program funded the Center to develop ad hoc networking radios and software under the *Autonomous Mobile Communication Relays (AMCR)* project. This technology was later leveraged on a more practical and logistically simpler system, the *Automatically Deployed Communication Relays (ADCR)* project. Funded by the Joint Ground Robotics Enterprise, several generations of *ADCR* systems introduced increasingly more capable hardware and software for automatic communication-link maintenance by deploying static relay nodes from mobile robots. This capability was tapped in 2010 to fulfill an urgent need from theater, resulting in 243 kits of ruggedized robot-deployable communication relays that were sent to Afghanistan to extend the range of EOD and tactical ground robots in 2012 (Nguyen et al., 2013).

Autonomy

The Code 717 Unmanned Systems Group has developed autonomous vehicles (air, land, and sea) for over 30 years, more recently specializing in mapping, localization, path planning, and route execution in complex GPS-denied indoor and outdoor environments. The branch's first autonomous UGV was the *Ground Surveillance Robot*, which in 1986 could automatically follow a pedestrian or slowly moving lead vehicle with no human intervention (Gage, 1995b). In the pre-GPS era of unmanned systems development, however, this early research surrogate also lacked dead-reckoning

encoder input and carried no inertial navigation unit, and thus was incapable of accurate localization.¹²



Figure 38. The *Ground Surveillance Robot (GSR)* was a surplus *M-114 Command and Reconnaissance Carrier* outfitted by Code 442 to serve as a surrogate testbed for autonomous navigation and collision avoidance, circa 1986.

For indoor applications, more sophisticated autonomous navigation strategies were introduced at the Center with the arrival of *ROBART I* (Figure 39a) and *ROBART II* (Figure 39b) in late 1986.¹³ The mapping, localization, path planning, and collision-avoidance algorithms developed by Gary Gilbreath on *ROBART II* were subsequently improved for incorporation on the Army's *Mobile Detection Assessment and Response Interior (MDARS-I)* robotic security program in 1990 (Figure 39c). The *MDARS-Interior* robot autonomy was ported to the *MDARS-Exterior* robot in 1995, and transitioned in 2003 to our *Unmanned Surface Vehicle (USV)* project for supervised autonomous operation in the maritime domain.

¹² It was, however, equipped with an agricultural John Deere Doppler radar for measuring forward velocity, and a modified laser rangefinder intended for landmark referencing.

¹³ *ROBART I* demonstrated fully autonomous indoor navigation and room-level localization in 1981 (Everett, 1982; 2005), followed by a much improved *ROBART II* in 1987 (Everett et al., 1988; Everett & Gilbreath, 1989).

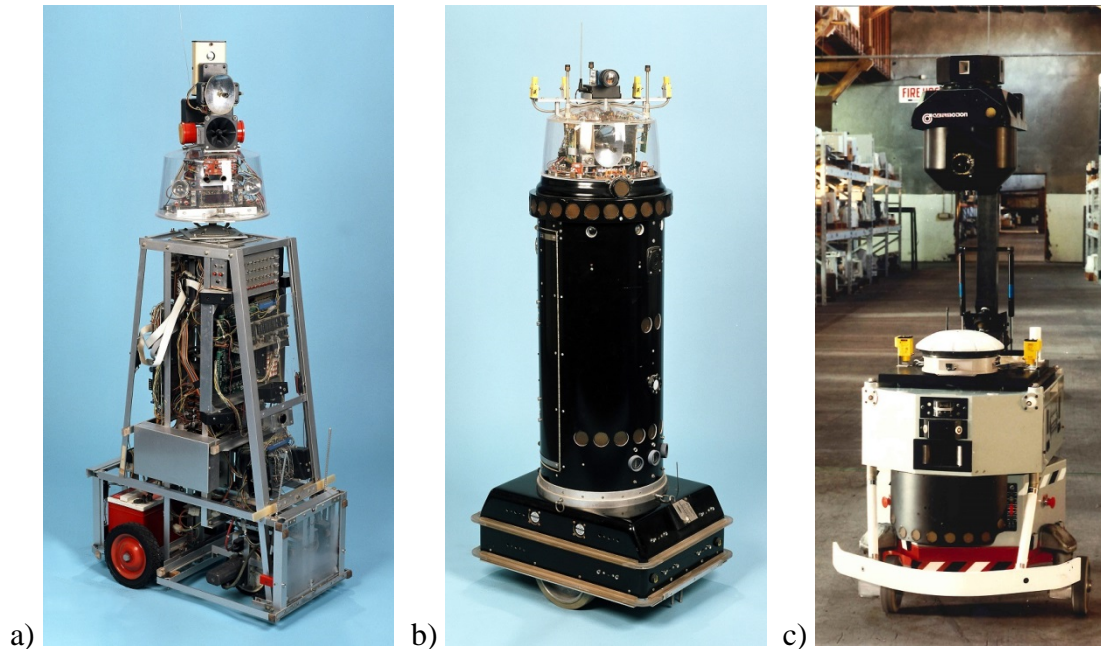

Figure 39. a) *ROBART I* (1980-1982). b) *ROBART II* (1982-1992). c) *MDARS-Interior* prototype (circa 1997).

The term “autonomy” is often overused and less often well understood, however, and the popular descriptor “fully autonomous” even more so. While a detailed discussion of this particular issue is given under the *Technology Transfer* project (2003-2007) in the chronological Project Summaries section of Volume 2, for introductory purposes here we shall focus on autonomy as applied to unmanned vehicle navigation. To further simplify things, the discussion will be constrained to unmanned ground vehicles (UGVs), with implied extension to other operational domains such as air and sea.

That being said, autonomous navigation for UGVs can be generally decomposed into four key components: 1) mapping, 2) localization, 3) path planning, and 4) route execution. Mapping involves generating some type of world model or map representation in which the unmanned vehicle can be localized, and which supports subsequent path planning to generate a series of waypoints leading to some desired destination. While early UGVs relied upon *a priori* map data, real-world operations require simultaneous localization and mapping (SLAM), in which the moving vehicle accurately perceives its surroundings to build its own map (Figure 40).

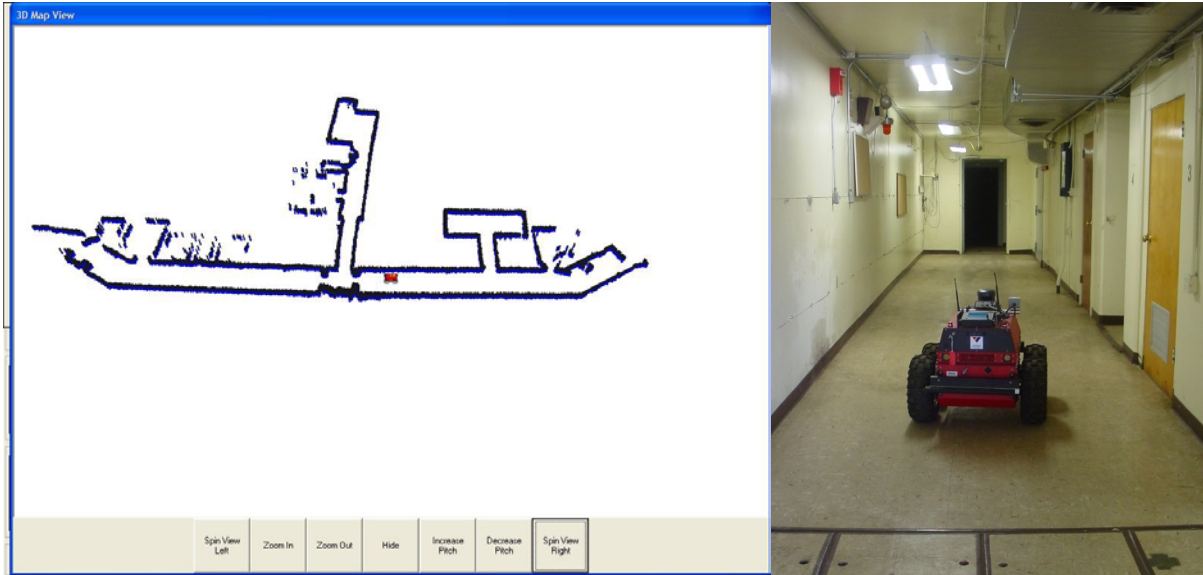

Figure 40. This robot-generated SLAM map (left) of Battery Woodward (right), a 15-room underground WWII bunker located on the Unmanned Systems Group's Central Test Site, was created from lidar range data collected by a Sick *LMS-200*-equipped iRobot *ATRV* as it autonomously explored the previously unmapped structure, circa May 2004.

The localization component involves incremental determination of vehicle position and orientation along the route being executed, and there are a number of synergistic strategies that make this possible, to include SLAM (Figure 40) and inertial measurement (Figure 41a), with a Kalman filter or fuzzy logic (Figure 41b) to optimally fuse the results. Path planning algorithms work on the world model representation (map) to calculate the most effective or desired route to achieve the destination goal, to include dynamic route replanning in response to actual real-world conditions encountered during transit. Once the path planner has determined an appropriate set of waypoints defining the desired path segment, the route-execution component encompasses all the behaviors required to successfully traverse from point A to point B to point C, etc.

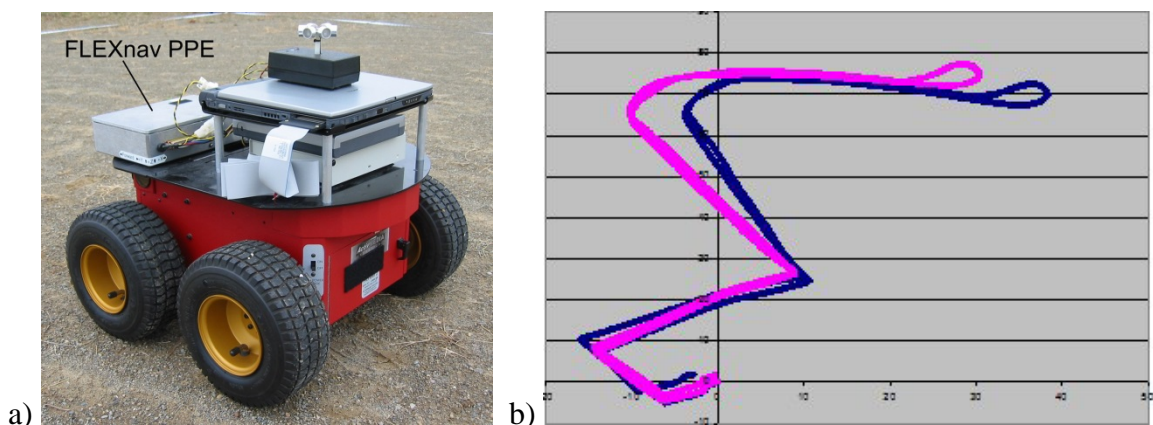

Figure 41. a) The University of Michigan's *FLEXnav PPE* (proprioceptive position estimation) precision dead reckoning system is shown installed on an ActivMedia *P2AT* (Ojedo, Reina, Cruz, & Borenstein, 2006). b) Comparison of Kalman-filter (pink) and fuzzy-logic (blue) fusion following a round-robin run that started at the graph origin (Pacis et al., 2006).

Probably the most obvious of these behaviors is collision avoidance, the intent being to safely execute each route segment without running into anything. Positive (above-ground) static obstacles are the easiest to detect, typically using lidar, radar, and/or video-based sensors, with predictive avoidance of moving objects a bit more difficult. Detection of negative-obstacles (below-grade hazards such as ditches or potholes) is tougher still, as they are largely occluded from view and hence hard to spot at a distance, particularly from fast-moving or low-profile vehicles (Figure 42). Effective slope determination is required for establishing ground truth in both the above scenarios, as well as for warning of unsafe terrain conditions.

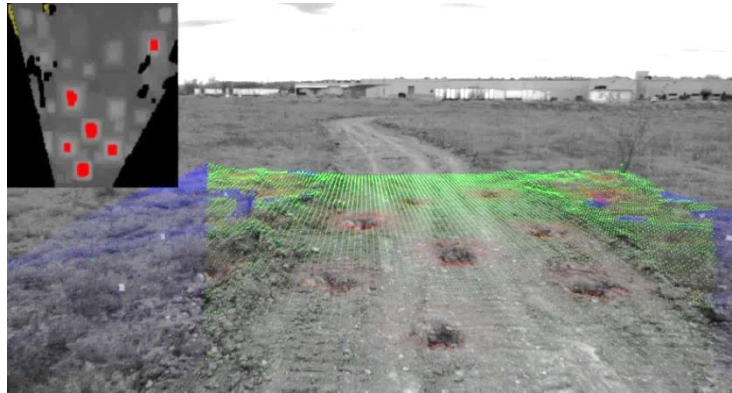

Figure 42. The red-colored areas in the inset at upper left correspond to perceived negative obstacles in the robot's path, based on 3D lidar scans of the unpaved road as shown in the main image.

Our more recent development of tip-over detection, warning, and prevention behaviors that analyze inertial forces acting upon the vehicle further lessen the chances of mishap (Figure 43). The software's ability to detect the vehicle model and any installed payloads can enable dynamic recalculation of the center of gravity, even while in motion, so corrective action can be taken to avoid accidents. This algorithm can be extended to accommodate proactive center-of-gravity reconfiguration to push the envelope of traversability, as for example extending the manipulator forward when climbing stairs.



Figure 43. Developed by Aaron Burmeister, Leah Kelly, and Kurt Talke, the tip-over prevention algorithm assesses the various accelerations acting upon the robot relative to its center of gravity (lower left quadrant) as it traverses the slope shown at upper right to detect, warn of, and/or prevent an impending accident.

Small-robot autonomy involving the above navigational components has always been a challenge, for three reasons: 1) limited space and payload capacity, 2) limited available energy, and 3) close proximity to the ground, which complicates both perception and communications. Addressing these issues became the highest priority, as man-portable EOD robots were being deployed in large numbers to Afghanistan and Iraq to address the growing IED threat. Accordingly, the group focused on expediting the development of autonomous navigation for man-portable robots (Figure 44), as well as the small lightweight perception sensors required to support same (Figure 45).

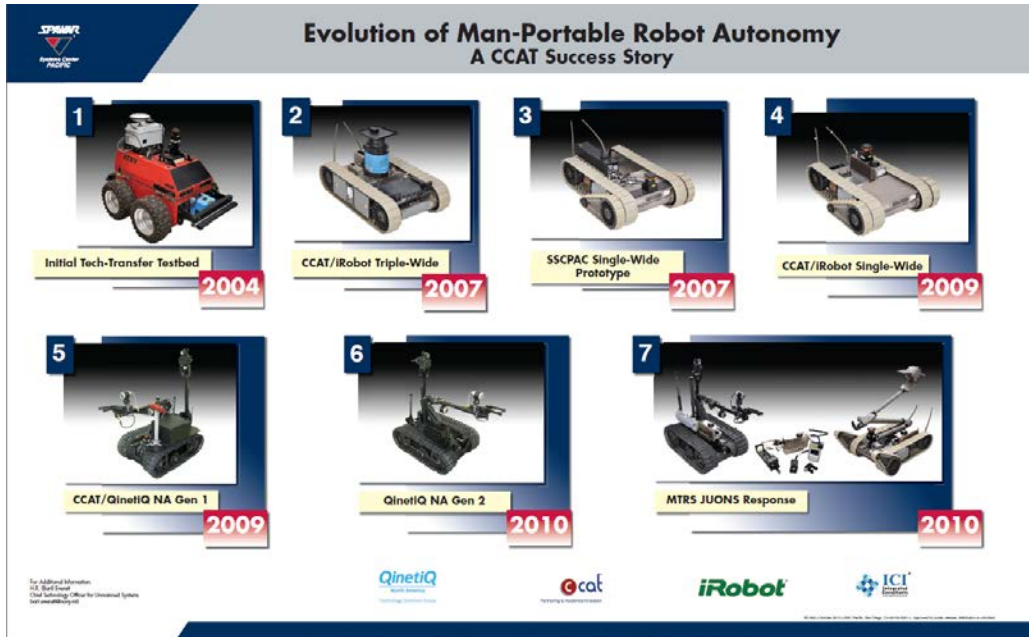

Figure 44. The development of man-portable robot autonomy for EOD applications was expedited by a focused effort that grew a 2004 laboratory prototype into a hardened system on a commercial robot by 2009, which was competitively selected in response to a Joint Urgent Operational Needs Statement (JUONS) the following year.

Perception

Localization, path planning, and route-execution behaviors such as collision avoidance and tip-over prevention rely heavily on perception to collect the geometric data required for creating high-fidelity world models that support autonomous navigation. The Unmanned Systems Group's use of the *CommonSense* cross-platform library facilitates integration of 3D sensors with the modular *Autonomous Capabilities Suite (ACS)* and *Robot Operating System (ROS)* unmanned-vehicle architectures. Primary focus areas include 2D and 3D lidar, monocular/stereo vision, and radar sensor systems collectively supporting the following:

- Multi-view stereo
- 360-degree camera arrays
- Fused 3D lidar and color images
- Point-cloud processing
- Spatial-phase sensing
- Large-scene and small-scene 2D and 3D modeling
- Feature estimation, surface reconstruction, and segmentation

Typical applications include:

- Enhanced depth perception and improved operator situational awareness
- 3D visualization for man-portable EOD robots
- Positive and negative obstacle detection and avoidance
- Visual odometry for enhanced dead reckoning
- GPS-denied navigation and localization
- Terrain-traversability assessment
- Autonomous stair detection, climbing, and descending
- Large-scale multi-story mapping
- Human motion and presence detection
- Tunnel exploration, mapping, and characterization
- Terrestrial and maritime force protection and security
- Intelligence, surveillance, and reconnaissance (ISR)

The evolution of perception sensors supporting the man-portable robot autonomy advancements shown earlier in Figure 44 is similarly depicted in Figure 45.

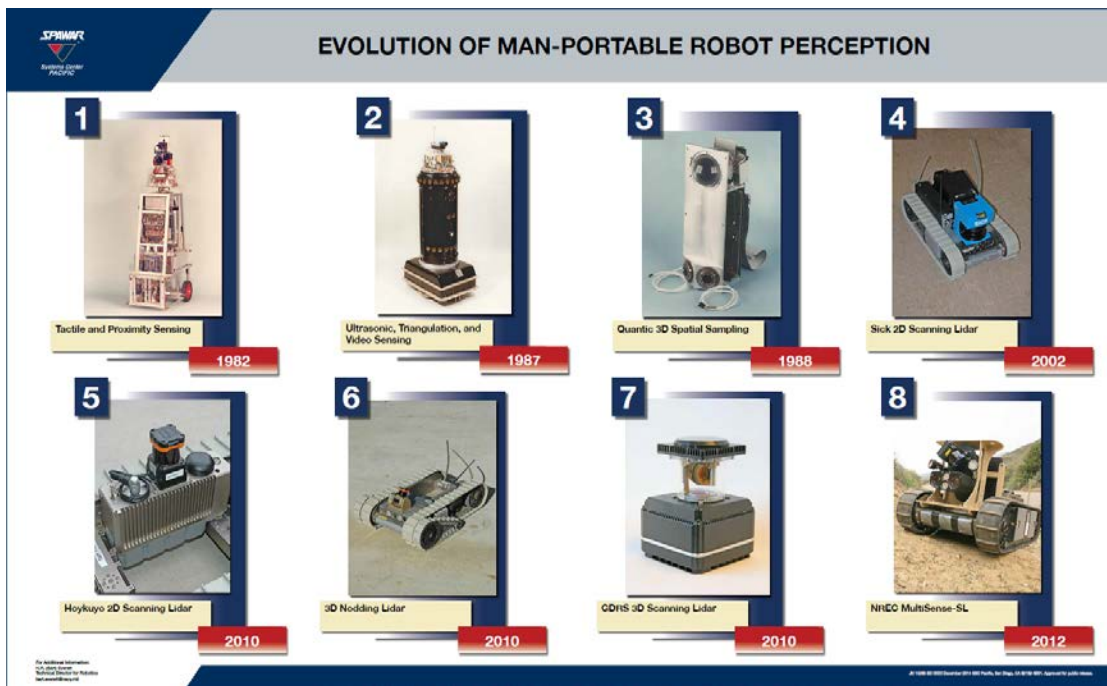

Figure 45. The development of practical perception sensors to support man-portable robot autonomy was challenged by the inherent size, weight, and power restrictions of small UGV platforms.

Data Mining

Prior to the drawdown of coalition forces in Iraq and Afghanistan, almost 8,000 counter-IED UGVs were operating on the ground in theater, each sending back 15 frames of video per second. This video data for the most part was not retained after the mission, as the primary role of the real-time perception was to provide operator situational awareness during teleoperation. The later introduction of limited autonomous navigation allowed lidar and stereo-based perceptual support for

certain intelligent behaviors that reduced the driving burden of the human operator, but to our knowledge the video stream was never used for such purposes in theater.

Thousands of UAVs were also flying in the skies above American troops on the ground, collecting and sending back even higher resolution video imagery. Most of this data was saved, as the ISR mission was the main reason the majority of these airborne drones had been launched in the first place. Analysts pouring over this flood of incoming imagery were soon overwhelmed, however, resulting in huge backlogs that forced the prioritization of post-mission analysis, which in turn reduced effectiveness and caused some degree of potentially relevant intel to inadvertently fall through the crack.

In retrospect, the collective employment of large numbers of unmanned air and ground systems can obviously generate an enormous amount of valuable ISR data, which could be “mined” post-mission to great tactical advantage. There currently are three fundamental problems hindering practical attainment of this goal, however, the first being it cannot be done quickly through conventional analysis. Secondly, effectively reviewing archived video data for targeted mission-relevant intelligence on short notice is also impractical using current practice. And thirdly, even if such timely and targeted retrieval were possible, traditional storage requirements for so much video data would quickly become unmanageable.

Our growing experience with 3D world modeling in support of autonomous UGV navigation suggested a very promising potential solution to all three of the above problems. In 2012, the *3D Visualization* project developed an ability to stitch successive UGV video frames together in near-real-time to create an accurate three-dimensional representation of a small volume of interest, such as a suspected IED site (Figure 46). This achievement was accomplished using structure-from-motion and feature-tracking algorithms developed by the University of North Carolina (UNC).



Figure 46. Created by stitching successive video frames together in 2 minutes or less, this 3D model of a training IED could be viewed by the UGV operator from any desired perspective for detailed near-real-time analysis.

A post-processing approach developed by the University of Washington for the Unmanned Systems Group’s *Urban Environment Modeling* project leveraged the UNC reconstruction algorithms and high-powered graphics-processing-unit (GPU) pipeline for stitching together asynchronous still images and video frames. The resulting capability to model a building (Figure 47) was later expanded to cover a full city block. This early work was based on the *Photo Tourism* research project pursued by graduate student Noah Snavely at the University of Washington

(Wikipedia, 2015),¹⁴ which was brought under contract for this project through the JGRE Robotics Technology Consortium.

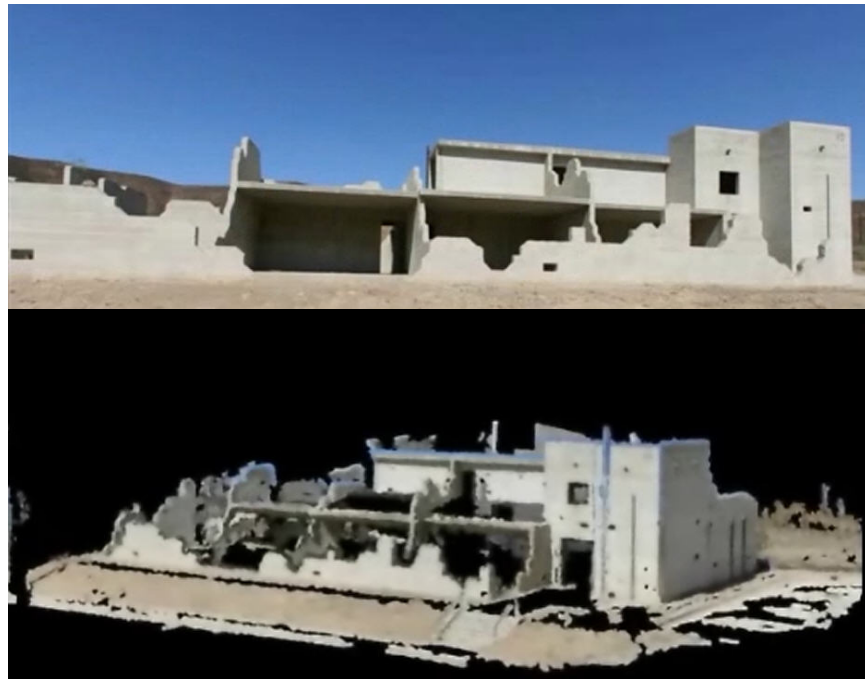

Figure 47. Numerous asynchronously gathered 35-mm still shots, such as this upper image of a “battle-damaged” structure at the Camp Pendleton MOUT site, were post-processed to generate the 3D representation at bottom. The user could intuitively fly through this model using the mouse to more closely view regions of specific interest.

In 2006, the *Photo Tourism* project used a huge assortment of asynchronously gathered Web images of varying resolution and standoff to generate a 3D model and point cloud of famous world landmarks, as for example the Eiffel Tower and Notre Dame Cathedral. Such a process could be continuously applied to the offline aggregation of individual video frames collected from air and land vehicles, creating a composite 3D representation that provided rapid and intuitive access to a warfighter’s specific region of interest. An additional benefit would be an upper bound on storage requirements, as redundant data would simply be discarded.¹⁵

Visualization

As previously discussed, effective visualization of video imagery can play an important role in two primary scenarios: 1) improved depth perception and situational awareness for the immediate user in the field, and 2) improved situational awareness during post-mission analysis.¹⁶ In either case, the collected perception data, while perhaps locally valuable to the unmanned system that gathered it, must be presented to the user in a manner that quickly conveys the needed information in intuitive fashion. If the human operator cannot readily visualize the significance of what he or she is looking at on the display, it is consequently of little tactical value in either of the above two scenarios.

¹⁴ Microsoft’s desktop application *Photosynth* is a refined version of *Photo Tourism* (Wikipedia, 2015).

¹⁵ While this would be a data-heavy and time-consuming process, it likely will become more practical as more capable APUs become readily available and new parallel processing techniques emerge.

¹⁶ Other potential applications include training and forensics (change detection).

In the first scenario, appropriate rendering of relevant data describing the task at hand via an optimal man-machine interface can greatly enhance operator situational awareness in ways never before possible, as illustrated in Figure 48. Before an operator cuts a command wire just uncovered on top of the pallet, for example, he or she may want to verify what color wire goes where on that part of the device behind the pallet. In the past, this meant driving the robot around to the back to physically take one more look, as opposed to manipulating the virtual camera perspective to accomplish the same goal while the robot stays put.



Figure 48. This 3D model of a mock-up suspected IED (left), created from video streams collected by the stereo-camera pair (top),¹⁷ has been merged with an avatar of the iRobot *PackBot*, which moves in concert with the actual robot to provide the operator with otherwise unobtainable near-real-time situational awareness.

As for the second scenario, the ability to generate large-scale high-resolution 3D models of the operating environment in near real time also opens up new opportunities for post-mission ISR analysis, which are significantly enhanced by appropriate rendering of the data-mining results. Such models could also support automatic change-detection algorithms that would substantially reduce the analysts' workload by alerting unusual activity that could then be visualized on a prioritized basis. In addition to fulfilling the navigational needs of supervised autonomous unmanned air and ground vehicles, 3D models of large urban environments could also be used to support warfighter training via mission simulation.

KEY SERVICE AREAS

The U.S. Department of Defense spends an enormous amount of money each year on the development of new and improved technology, and an even larger sum of money is annually expended to support the use of technology, both on and off the battlefield. For a variety of reasons beyond the scope of this document, however, the most persistent problem is rapid and effective transition of newly developed technology into the actual hands of the warfighter in theater. In recognition of this potentially crippling limitation (commonly known as the “valley of death”), we implemented several key service areas aimed at expediting far more timely response to emerging threats, three of which are briefly summarized below.

¹⁷ This stereo-camera vision system was developed by the NASA Jet Propulsion Laboratory (JPL), Pasadena, CA.

Evolutionary Systems Engineering

The *Evolutionary Systems Engineering Model for Unmanned Systems* shown in Figure 49 is based on a wave model adopted by DoD as best practices for Systems of Systems Engineering (SEG, 2008; Dahmann et al., 2011; Scrapper et al., 2016; Dove et al., 2016).¹⁸ In 2013, this DoD model was extended by the Code 717 Unmanned Systems Group to support the integration, test, and experimentation of autonomous systems (Scrapper, 2014). The result was a continuous improvement process for: 1) assessing system capabilities and limitations; 2) maturing needed technologies based on key performance parameters; and, 3) reducing project risk by understanding performance tradeoffs and associated costs as the system evolves.

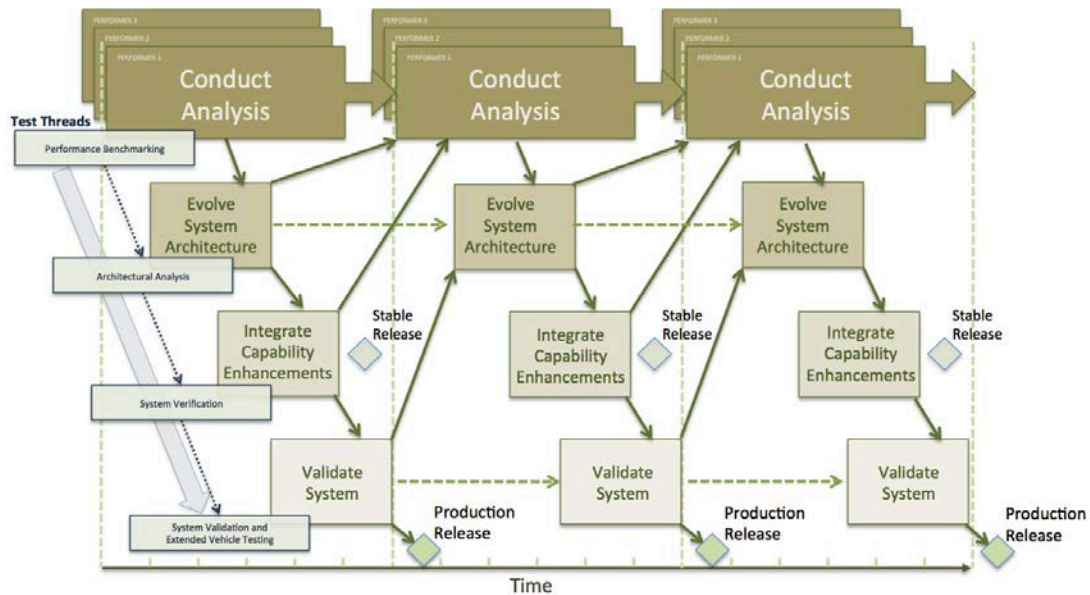

Figure 49. Developed by the Code 717 Unmanned Systems Group under the direction of Chris Scrapper, the *Evolutionary Systems Engineering Model for Unmanned Systems* defines a systematic process and overarching strategy for insertion of new technology, accumulation of evidentiary information, and management of risk.

The strategy chart shown in Figure 50 illustrates all major processes and milestones for the development, assessment, and integration of new and maturing technologies into the baseline autonomous system. Each technology that is introduced must follow a systematic approach for diagonal progression from conception to validation. The model partitions a wave (diagonal green arrows leading to incremental production releases along timeline at bottom) into four overlapping phases: 1) conduct analysis, 2) evolve system architecture, 3) integrate capability enhancements, and 4) validate system. This wave approach decouples the maturation and integration processes, and expedites incremental delivery of evolving capabilities.

¹⁸ The concept of “Wave Planning” was developed by Dr. David Dombkins (2007).

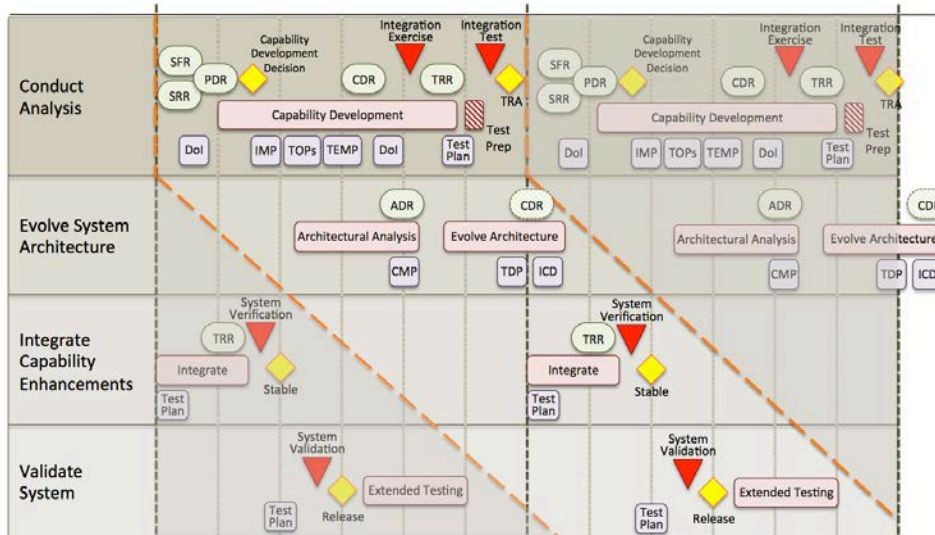

Figure 50. Wave-model-based Evolutionary Systems Engineering Strategy, with waves illustrated here by dashed red diagonals leading to incremental production releases across timeline at bottom.

This decoupling allows successive iterations of increasing capability to spin off in the form of periodic production releases for user evaluation and potential fielding, while parallel efforts continue to address the more difficult challenges. The previously discussed *TeleOperated Vehicle* project, initiated in 1985 by Code 531 at the Hawaii Lab and later handed off to Code 535 in San Diego for operational evaluation, could have significantly benefitted from such a wave approach. Instead, when the exploratory concept-development prototype proved insufficiently robust for rugged USMC field testing and demonstrations, a new version had to be designed and built from the ground up.¹⁹

Standardized Test Methods

Understanding the performance trade-offs for a variety of complex and evolving unmanned-systems configurations, then verifying that potential solutions can meet the performance objectives for a given mission set, are growing problems for DoD program managers. The lack of consistent test methods and objective evaluation procedures has seriously hampered users, developers, and program managers in comparing alternatives, understanding trade-offs between different configurations, and verifying that unmanned systems are meeting the prescribed performance objectives for a given mission set.

Standardized test methods are therefore key to expediting the achievement of technology readiness levels (TRLs) suitable for timely fielding of such systems in their respective operational domains, for the following reasons:

- Program managers can use the test methods to clearly articulate program goals in terms of desired system capabilities, to encourage innovation, and to periodically measure outcomes.
- Developers gain an understanding of specific robotic capabilities needed by various user groups through Standard Test Method apparatuses, then use them to practice and refine robot designs.
- Warfighters benefit from the expedited deployment of unmanned systems that are cheaper, more effective, and more reliable.

¹⁹ See further discussion of this case study under the Project Summaries section, this volume.

The Unmanned Systems Group has worked closely with the National Institute for Standards and Technology (NIST) to adopt their standardized test methods for unmanned systems, and have NIST-certified test fixtures in house, but insufficient space to set up and use them. The new “Unmanned Systems Integration, Test, and Experimentation facility” (Building 585) will support development of standardized test methods with appropriate test instrumentation, enabling far more effective inter-comparison of unmanned-systems performance. (See later discussion under the Facilities subsection.)

Rapid Prototyping

In 2013, at the initiative of senior mechanical engineer Kurt Talke, the machine shop was upgraded to a *Rapid Analysis Design and Prototype Center* (Figure 51), with funding provided by the Naval Innovative Science and Engineering (NISE) program and other sources. Some of the more significant equipment procured under this effort included the following:

Vertical machining center (Hurco *VM10*)
CNC lathe (Trak *1630SX*)
Waterjet cutter (Flow *Mach2*)
Knee mill (Trak *K3*)
Environmental chamber (Sub-Zero *ZP-64*)

3D printer (Stratasys *Fortus 250MC*)
3D laser scanner (Romer 7 Axis)
Laser engraver (Epilog Laser *Mini-24*)
Digital force-measurement machine
PCB manufacturing oven



Figure 51: Examples of the new rapid-prototyping equipment in productive use include the Southwestern Industries Trak *1630SX* lathe (upper left), Hurco *VM10* vertical machining center (bottom left), the *VM10* cutting aluminum (center), and the TRAK lathe in action (right).

This state-of-the-art computer-numerically-controlled (CNC) equipment greatly expedited mechanical design and fabrication over multiple prototype iterations, allowing projects to be completed in a much faster and more efficient manner. Mechanical parts and/or assemblies can now be fabricated in-house as opposed to vended out, reducing costs and long lead times associated with conventional procurement. In the past, project engineers had to design each part to perfection before

submitting for fabrication, because commercial machine shops would take a long time and charge a lot of money, all of which would be wasted in the event of a mistake. The ability to quickly 3D print a plastic prototype for a sanity check prior to final fabrication in metal is a huge advantage (Figure 52).

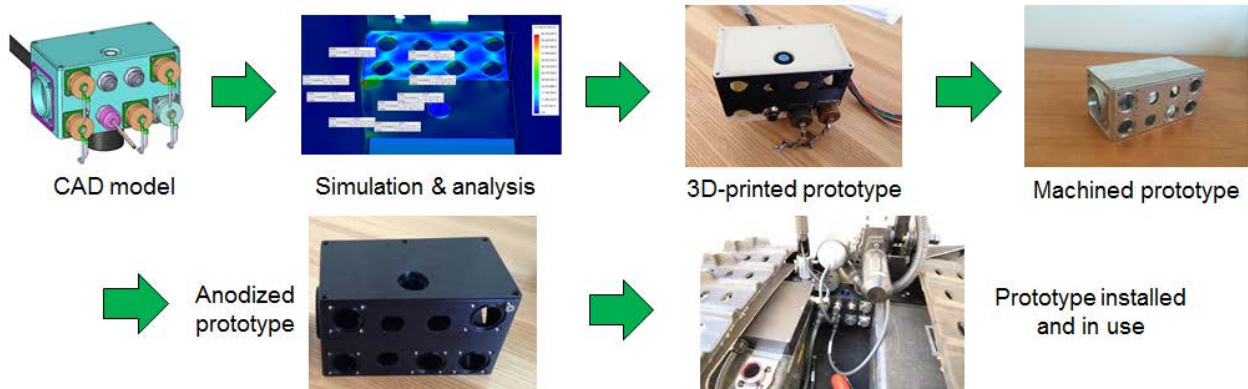

Figure 52. This typical project design, analysis, and development cycle significantly reduced both time and cost, facilitating a more rapid and effective response to emergent warfighter needs while fighting two wars where the threat could change weekly.

A few representative project examples enabled by this new facility are outlined below, each of which is further discussed under Project Summaries in Volume 3:

Retrotraverse Payload – Developed for NAVEODTECHDIV in response to *JUONS-CC0333* for use on both the iRobot *PackBot* and QinetiQ NA *Talon* EOD robots, this add-on autonomy module supported the following:

- Retrotraverse upon lost communication
- Retrotraverse to a predetermined location
- Waypoint navigation
- Leader-follower behavior
- Follow-the-OCU behavior
- Framework for implementation of other advanced behaviors

Manually Deployed Communications Relays – Also developed for NAVEODTECHDIV in response to *JUONS-CC0412* for use on both the *PackBot* and *Talon* EOD robots, this quick-turn-around effort provided communication mesh networking using all available RF nodes. This approach allowed *PackBots* and *Talons* to relay for one another and/or to use each other’s relay nodes, resulting in more CONOPS flexibility with greater operator standoff.

RoboZap – Developed in support of the U.S. Army Rapid Equipping Force (REF) for neutralizing improvised explosive devices, this system was based upon a commercial *BobCat* vehicle outfitted with a QinetiQ NA applique kit for teleoperation. The rear-mounted payload was a high-voltage generator developed by Xtreme Alternative Defense Systems (XADS) that charged two electrodes trailing over the ground, which collectively introduced a decapacitating current spike in buried IED command wires

On the electronics side, the unmanned systems group uses *Altium Designer* as the printed circuit board (PCB) design tool, which offers schematic capture, PCB layout, *SPICE* simulator and signal integrity analysis. To test specific functions of a larger circuit, we are capable of prototyping two-

layer PCBs in house using the LPKF S63 plotter (Figure 53). This plotter is capable of creating small geometries, such as 0.1 mm (4 mil) track width/separation and pads for 0201 (0.6 mm x 0.3 mm) components. With a 10-tool auto-exchanger, the plotter finishes a single side without supervision, requiring only a manual flip of the copper clad to finish the second side. PCB assembly is for the most part executed manually.

▼ Rapid PCB Prototyping

- LPKF S63 plotter with auto tool exchange
- Double-sided PCBs (upgradable to 8 layers)
- Milling down to 0.1 mm thick traces
- Milling for 0201 components (0.6 x 0.3 mm)



▼ PCB Assembly and Rework

- Precision component placement using PL550 (e.g., ball-grid array package)
- Component soldering of bottom-terminated components like BGAs and components with thermal tab using infrared soldering (IR) station IR550
- Depopulating (desoldering) components with IR550



▼ High Power Microscope

- x7 to x40 magnification Lynx microscope
- LED ring illumination
- Used for manual placement and hand-soldering of components
 - 0201 components
 - 0.5 mm pitch packages

Figure 53. Some of the equipment used in our advanced printed-circuit-board fabrication lab in Building 622.

The use of a Vision Engineering high-power *Lynx Elite* microscope with adjustable magnification (between 7x and 40x) allows 0201 components and integrated circuits with 0.5-millimeter pitch to be soldered by hand. This microscope also facilitates inspection of boards for correct assembly and identification of potentially damaged components not visible to the naked eye. Bottom-terminated components (BTCs) such as ball-grid arrays or components with thermal tabs, which cannot be manually assembled, are handled by a Kurtz Ersa *PL550* pick-and-place machine and *IR550* infrared soldering station. The pick-and-place machine allows application of solder paste to BTCs, followed by precision placement onto the PCB. The *IR550* is then used to solder the component using the appropriate heat profile. For rework, the *IR550* can also be used to depopulated components without damaging the PCB.



Figure 54. Electrical engineer Daniel Leung inspects the final assembly of a *ModKit Electronics Stack* completed by Yuong Sun at the advanced printed circuit board work center in Building 622.

FACILITIES

As the Adaptive Systems Branch's 1986 Seaside accommodations consisted of only three dilapidated trailers and an empty shell of a warehouse with no heat or hot water (Figure 55), there was a serious lack of adequate workspace for effective execution of unmanned systems development. Since the warehouse structure was not climate controlled, significant corrosion problems were experienced with the electronic circuit boards in the robots, as well as the associated tools and test equipment used in the space. These major shortcomings adversely affected not only the branch's efficiency, but more importantly, the perception of its potential capabilities by visiting sponsors who were expecting to see a state-of-the-art facility.

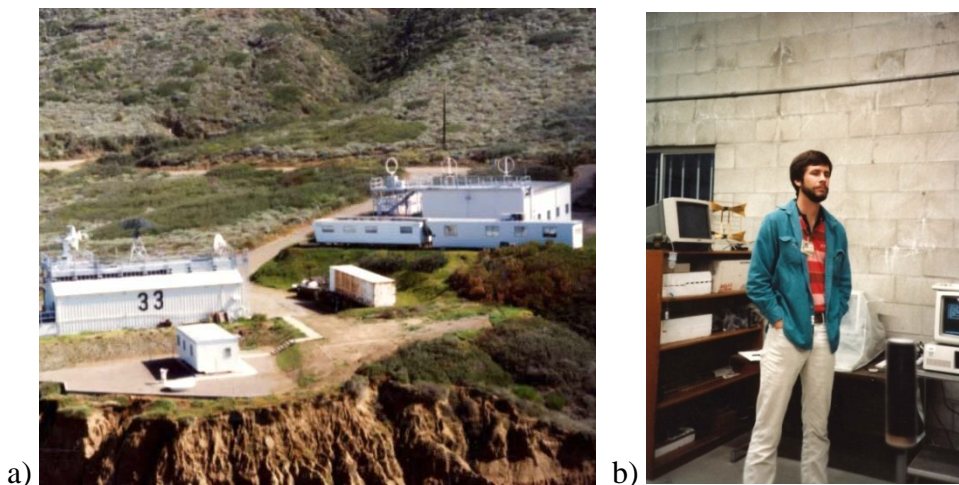

Figure 55. a) Building F-36, surrounded by aging trailers at upper right, as shown looking east in 1988. Buildings 622 and 624 would later be constructed in the open area this side of Woodward Road at upper left (see Figure 57). b) Electrical engineer Gary Gilbreath in Building F-36, which lacked heat, hot water, and partitions, circa 1987.

Commander Bart Everett, who ran a part-time construction company to supplement his Navy scholarship at Georgia Tech in the early 1970s, began working nights and weekends in 1988 to outfit Building F-36 with partitions and ceilings (Figure 56). As this was the branch's only building at the time, the upgrade was conducted in four successive phases to allow work to continue on the USMC *Teleoperated Vehicle (TOV)* project during the renovation. The result was a far more suitable environment for software development, with a new shower-equipped bathroom, a conference room, a separate technician's space, a lab area, and an open bay in the center for testing the *ROBART II*, *ModBot*, and *MDARS* indoor robots.

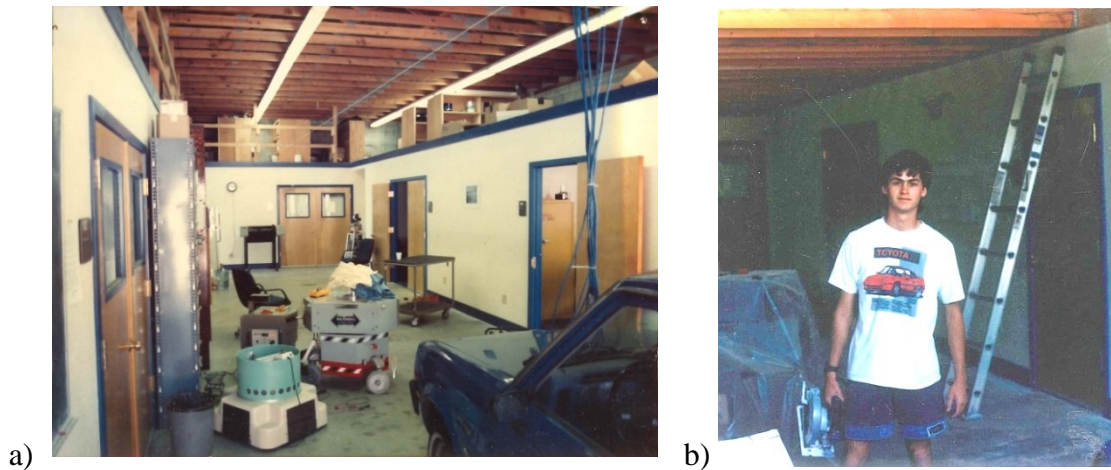

Figure 56. a) Over a period of approximately 4 months, Commander Everett partitioned Building F-36 on his own time in stages: rooms 101 and 102 at left, rooms 104-107 at the north end (background), and rooms 108 and 109 at right. b) Todd Everett assisted his dad on weekends with the final ceiling-joist installation over the central bay.

The terrain along Woodward and Gatchell Roads was scouted for outdoor test sites for the *TOV* project, with the subsequent selection of the Battery Gillespie area just south of the northern fence line and west of Woodward Road (Figure 57a). A gate in this fence could be opened to allow expanded runs along Woodward Road through adjoining Navy property to the north (Figure 57b). The *Surrogate Teleoperated Vehicle (STV)* follow-on to *TOV* also underwent off-road testing at this site in 1992. The following year, the *MDARS-Exterior* dune-buggy surrogate was demonstrated here to convince the sponsor that retrofitting an existing vehicle was problematic.²⁰ Numerous projects use this Northern Test Site today for readily available outdoor evaluation.

²⁰ With the more recent introduction of commercial drive-by-wire systems, the philosophy today is just the opposite.

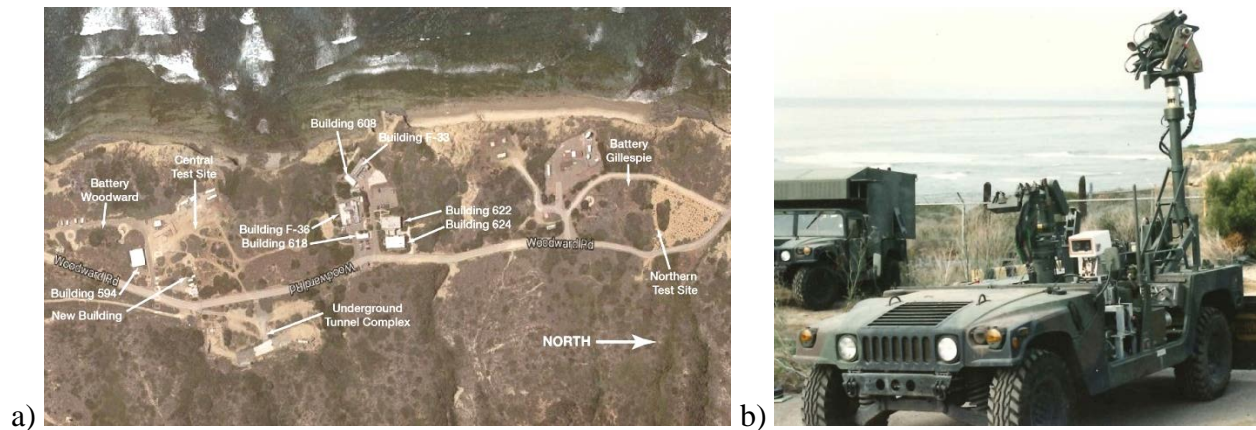

Figure 57. a) The Unmanned Systems Group campus along the Pacific Ocean on Woodward Road, circa October 2015 (satellite image courtesy *Google Maps*). b) The Northern Test Site in the Battery Gillespie area was extensively used during testing of the USMC *Ground Air TeleRobotic Systems (GATERS)* project, circa 1988.

In 1991, Commander Everett constructed a north-wing addition to Building F-36 to house a small machine shop that would better support emergent requests for quick-turnaround solutions to user needs (Figure 58). The WWII-era Bridgeport mill that had occupied a small corner of the F-36 bay was relocated to this addition and complemented with surplus equipment rounded up from various Center sources, including a drill press, band saw, sheet-metal shear, and forming brake. To provide heat during the winter and protect the Unmanned Systems Branch’s growing collection of expensive equipment from the corrosive salt-laden Pacific Ocean mist, Seaside Facilities Manager Tom Gaydos arranged for the entire building to be air conditioned.



Figure 58. Commander Everett added the north wing machine shop lean-to addition (behind car) to Building F-36 in 1991, which was later expanded westward (to right of windows) as part of the contracted south-wing addition to the building (extreme left) in 2010.

The *GATORS/TOV* project employed a number of *HMMWV*-based vehicles (two as *UGVs*, two equipped with command and control shelters, and one for cable recovery), which seriously overtaxed the limited capacity of *F-36*. In response to this need, Seaside Facilities Manager Tom Gaydos offered up two prefabricated Vietnam-era “Butler Huts” stored in wooden crates just north of the San

Diego Sewer Plant. These galvanized-steel kits were quickly erected by branch personnel (on concrete slabs poured by Facilities) as Buildings 608 and 618 (Figure 59). This identical pair of 20-foot by 48-foot climate-controlled structures added much needed indoor work areas for large unmanned vehicles at virtually no cost.

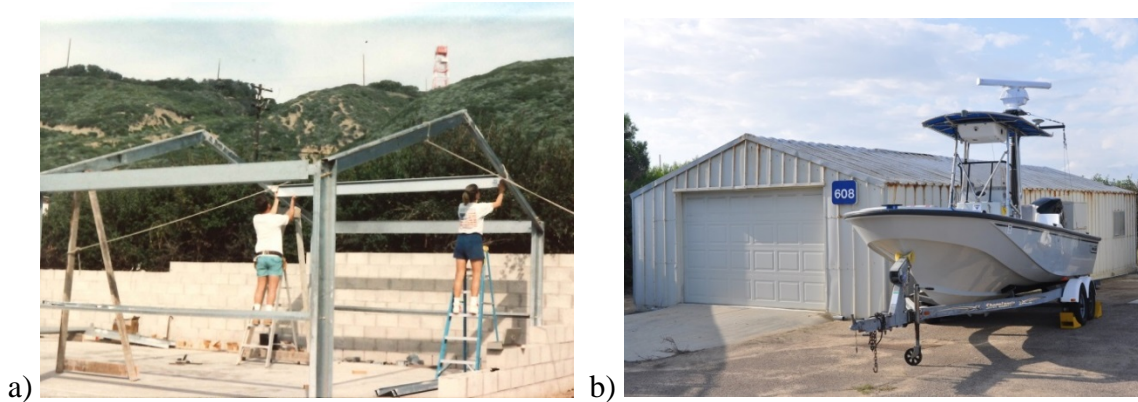

Figure 59. a) Bart Everett and Tracy Heath-Pastore begin assembling the steel framework for Building 618 in 1993. A new parking lot was later constructed on the east side of this structure along Woodward Road. b) Building 608, circa 2015, was similarly erected by Adaptive Systems Branch personnel southeast of Building F-33 (see again Figure 57).

Following relocation of the former occupant at the end of the Cold War in 1992, an indoor robotic test facility was created inside Battery Woodward (Building F-12), a 200-Series WWII coast-defense gun battery. Almost all of the Center’s indoor UGV programs conducted some form of testing over the years in this 15-room underground bunker (Figure 60), as further discussed in the Project Summaries section. Additional outdoor test areas were set up just north of this site for tethered testing of vertical-takeoff-and-landing air vehicles, along with a free-flight launch pad and covered-slab area for test personnel and observers. A large tilt table designed by lead mechanical engineer Aaron Burmeister was erected for man-portable UGV stability tests.

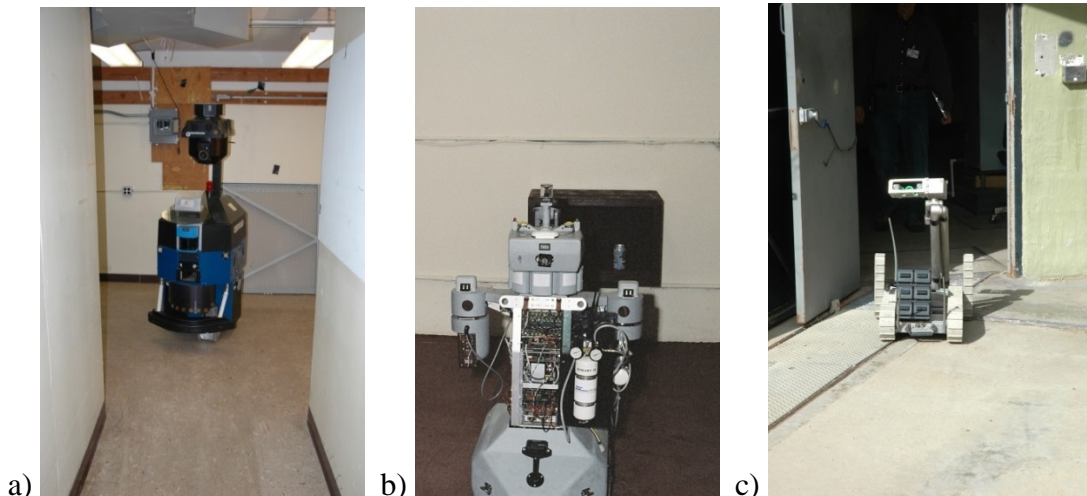

Figure 60. a) The *MDARS-Interior* robot undergoes testing in Battery Woodward, circa 2000. b) *ROBART III* finds its designated target (soda can in brown box) after searching the underground bunker, circa 2004. c) An iRobot *PackBot* enters Battery Woodward during tests of the communications relay deployer module, circa 2007.

To provide a more realistic set of navigational path segments for the *MDARS-Interior* robot development in Building F-36, a 6-foot-wide concrete apron was installed along the south and east sides of the structure as shown in Figure 61a. This simple but effective upgrade allowed the robot to exit the building interior through the roll-up garage door and patrol outdoors, effectively doubling the available route-segment footage at minimal cost almost overnight. Once again, we greatly benefitted from the positive can-do attitude of our Seaside Facilities Manager Tom Gaydos (Figure 61b), who unfortunately retired a short time later.



Figure 61. a) A 6-foot-wide concrete apron was added around F-36 to provide more complex pathways for testing the *MDARS-Interior* robot. b) Commander Bart Everett (left) delivers a heartfelt thank-you speech for Seaside Facilities Manager Tom Gaydos during the latter's potluck retirement picnic at the volleyball court.

In 2001, Building F-33 overlooking the Pacific was remodeled to replace the leaky windows, remove the large Faraday cage inside, and demolish the makeshift radar equipment room at bottom right in Figure 62a. Given its close proximity to the sea, a central air conditioning system was installed to provide a climate-controlled environment for five new lab and office spaces. An extra wide entry hallway with a glass door and windows facilitated test and evaluation of man-portable exterior robots. The test engineer could set up as shown in Figure 62b for good visibility of the robot operating in the adjacent parking lot and along Robart Road.

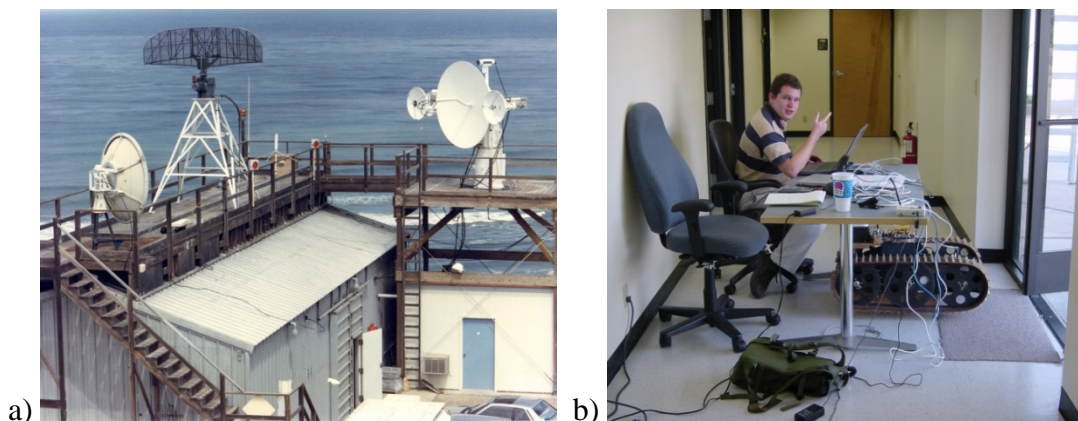

Figure 62. a) Shown looking northwest, circa 1987, Building F-33 was originally occupied by another code performing high-resolution radar research. b) This 2002 photo shows engineer Jeff Muehlhauser performing outdoor testing of the man-portable *URBOT* from the remodeled entryway of F-33.

To further accommodate our growing staff, construction of the ground floor of Building 622 began in the spring of 1992, soon followed by Building 624 just to the east (Figure 63). Each of these identical structures had 11 rooms, including a large lab area and a conference room. As more engineers were brought on board to support the steadily increasing number of projects, Commander Everett partitioned off a few of the larger rooms to provide additional offices. In anticipation of the growing need for space, both these buildings were designed and built to support a subsequent second-story addition.



Figure 63. Newly constructed Buildings 622 (grey roof) and 624 (red roof) are shown at upper left in this aerial view of the growing unmanned systems campus overlooking the Pacific Ocean on Woodward Road looking east, circa 1994. Note sand volleyball court just to the south at center right.

In the spring of 2004, construction began on the planned second-floor upgrade to Buildings 622 (Figure 64), complete with 20 new office spaces, a securable storage area, and an additional restroom. In 2007, a similar second-floor addition was added to Building 624 next door, with 10 offices, a restroom, and a dedicated server room. Initially left open for use as an indoor-robot assembly and test area, the remaining square footage was eventually replaced by a six-cell cube farm to accommodate New Professionals and summer interns. By this time, the Unmanned Systems Branch had reached critical mass for office and lab space, and the focus shifted to the facilitation of unmanned ground vehicle support for the war effort in Afghanistan and Iraq.

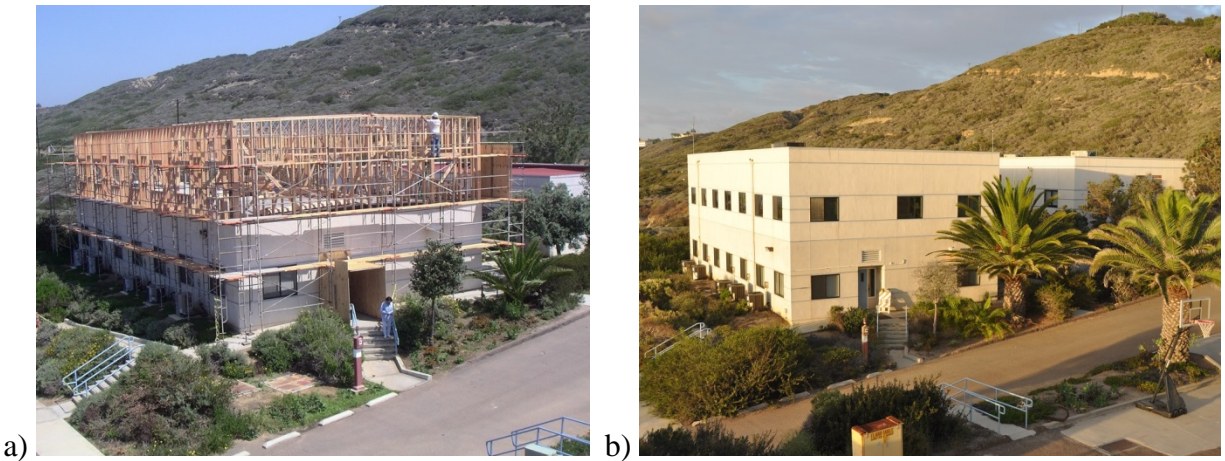

Figure 64. The second-story addition to Building 622 is shown midway through the framing phase, circa April 2004, with the single-story Building 624 at background right. b) Buildings 622 and 624 in 2015. The WWII-era switchback roads on the hill at upper right were earlier used for dune-buggy testing.

New construction began in 2006 for Building 594, a 3000-square-foot structure for medium and large unmanned-vehicle development. The highlight of the grand-opening ceremony on 1 May 2007 was when Commander Mike McMillan, executive officer of Space and Naval Warfare Systems Center San Diego, cut the ribbon using a QinetiQ *Talon* robot (Figure 65a). A rail-mounted overhead crane assisted in the assembly and maintenance of large system components, with a double garage door for vehicle access. Initially used to store and support two unmanned surface vehicles, Building 594 currently serves as the base of operations for the ONR 30 *Ground System Autonomy* project (Figure 65b).

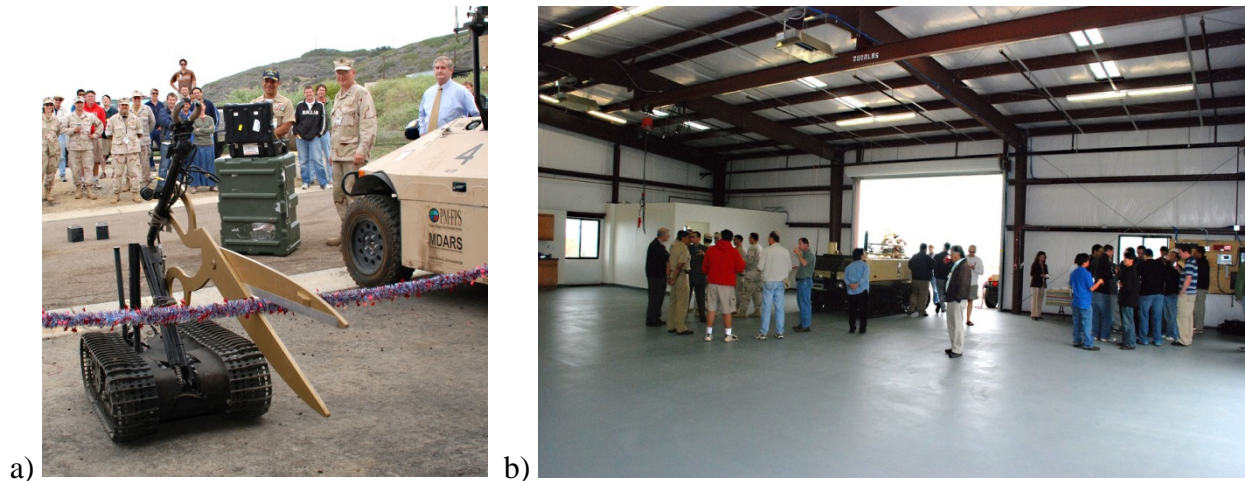

Figure 65. a) Commander Mike McMillan (center) operates a QinetiQ *Talon* robot equipped with ceremonial shears during the Building 594 ribbon-cutting ceremony on 1 May, 2007. b) The roomy interior of the new high-bay structure would soon be filled with a variety of large unmanned surface vehicles and exterior ground robots.

In 2007, the Unmanned Systems Branch's Southern Test Site for more rugged 3D-terrain off-road testing of unmanned ground vehicles was established at the south end of Gatchell Road (Figure 66a), just north of the San Diego Sewer Plant. As this location was some 1.2 miles away from the main campus, a prefabricated steel support structure (Building 651) was erected for electrical power, telephone service, and work and storage areas (Figure 66b). This facility was used by the Unmanned Systems Reserve Unit for training and other exterior robot testing, and later by flight-systems engineer Nick Stroumtsos for indoor UAV swarm demonstrations. It currently supports testing for the ONR 30 *Ground System Autonomy* project along Gatchell Road and the parallel dirt trail to the east (see Figure 66a).

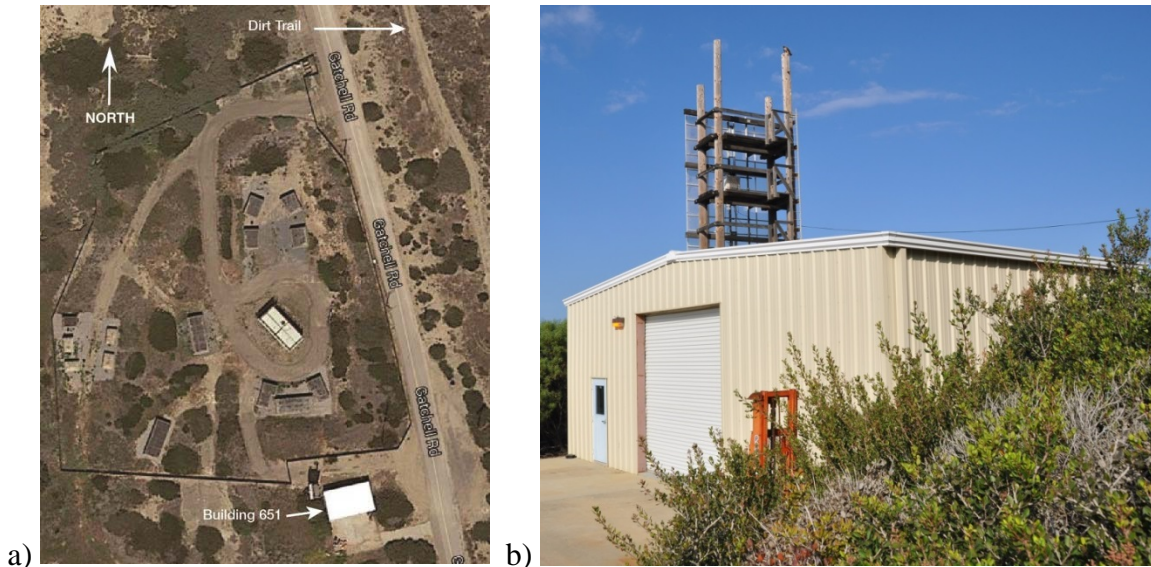

Figure 66. a) Building 651 was constructed on the Southern Test Site adjacent to the Pacific Ocean just north of the San Diego Sewer Plant (satellite image courtesy Google Maps). b) Building 651 in 2015. The tower structure in background was part of Convair's *Atlas* intercontinental ballistic missile test site in the 1950s.

By 2013, a remodel and expansion of Building F-36 had refurbished both restrooms, rebuilt the rooftop observation deck, added a new south wing for office spaces, and extended the north-wing machine-shop area to accommodate the expanded CNC rapid-prototyping facility. The following year, a Capital Investment Plan (CIP) Minor Construction Proposal was submitted for a 6000-square-foot pre-engineered steel structure (60 ft. x 100 ft. x 25 ft. high) to serve as an Unmanned Systems Integration, Test, and Experimentation (UxSITE) facility. A concrete pad on the south end of the building will accommodate two 40-foot ISO containers that can be moved into position in support of emergent test requirements.

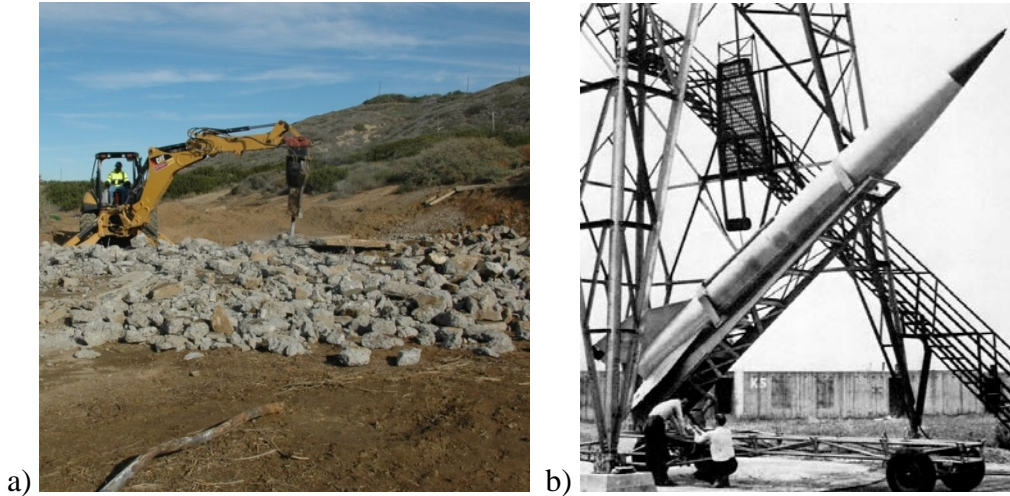

Figure 67. a) Site preparation for Building 585 began with demolition of the foundation for the oil-well derrick that supported the Convair *MX-774* missile in 1949. b) The *MX-774* was a post-war German *V-2* derivative that was the precursor to the *Atlas* intercontinental ballistic missile, which was later tested north of the San Diego sewer plant.

Michael Bruch, Tracy Pastore, and Rachel TenWolde attended the Final Design Review for Building 585 in early December 2015. Site preparation began later that same month west of Woodard Road (Figure 67a), and the main slab was poured on 28 January (Figure 68a). The steel support structure was completed in February and installation of the exterior panels and insulation well underway (Figure 68b), with a projected final completion date of June 2016. This new facility will support rapid integration and standardized testing of sensors, subsystems, outdoor vehicles, command-and-control systems, and integrated unmanned systems of systems.

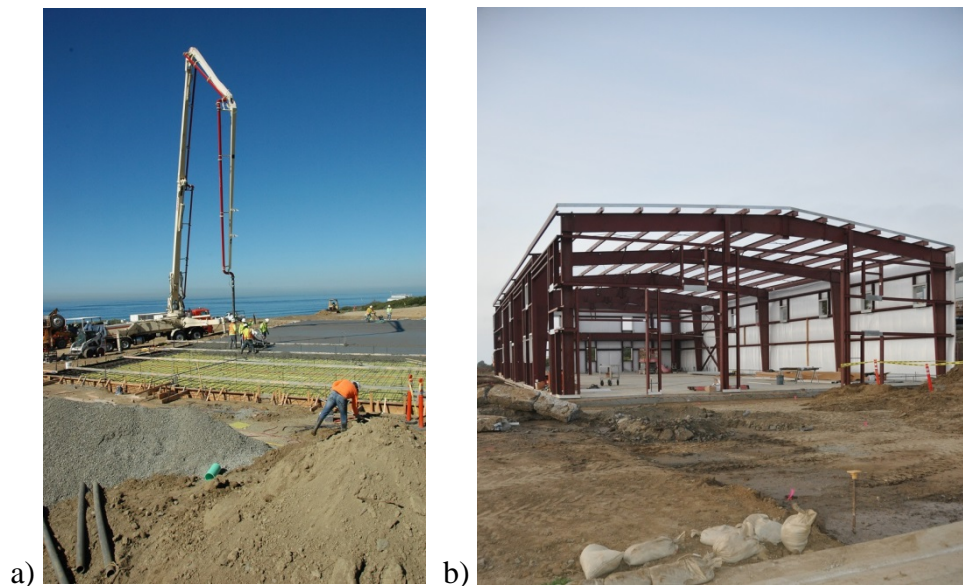

Figure 68. a) The main slab for Building 585 was poured on 28 January 2016 at the Central Test Site, just north of Woodward Loop across from Building 594. b) Building 585 construction looking north on 29 February 2016.

PROJECT SUMMARIES

Continuing S&T development of key supporting technologies such as autonomy, navigation, multi-agent behavior, and common control is critical to effective fielding of robust and adept unmanned systems. The modular open-architecture approach employed by the Code 717 Unmanned Systems Group greatly facilitates both evolutionary upgrade and technology transfer, allowing new projects to benefit from prior efforts, most of which went through their own iterative stages of continuing enhancement.

From just a handful of projects in the early 1980s, the group's involvement had progressively expanded to more than 50 ongoing programs and initiatives at the end of FY 2014, funded by various service and government agencies. Short summaries of the many endeavors across all operational domains (air, land, and sea) are presented in chronological order throughout the remainder of this document (and follow-on Volumes 2 and 3), broken out by decade, with numerous references to related publications offering greater detail. See also the project history timeline graphic presented in Appendix F.

CHRONOLOGICAL PROJECT SUMMARIES (1970–1979)

Remote Unmanned Work System (1970-1980)

While preliminary work leading to the *Remote Unmanned Work System (RUWS)* actually began in 1968, the first of several demonstration dives took place off Oahu, HI, in the mid-1970s (Lemaire, 1988). The tethered submersible was designed to perform a variety of underwater tasks at depths as great as 20,000 feet (Figure 69), giving it access to 98% of the ocean floor (Talkington, 1978). Developed by NOSC under the *Deep Ocean Technology Program*,²¹ the complete *RUWS* system consisted of the Work Vehicle and the Primary Cable Termination (PCT) component to which it was firmly attached during deployment and recovery.



Figure 69. Shown here at the NOSC Hawaii Laboratory on Kaneohe Marine Corps Air Station, Oahu, the *Remote Unmanned Work System (RUWS)* Work Vehicle measured 4.5 by 4.5 by 11 feet long, weighed 4300 pounds in air, and could operate down to 20,000 feet (Talkington, 1978).

²¹ The *Deep Ocean Technology Program* was managed by the Naval Sea Systems Command (NAVSEA 05R2).

Once released at depth, the *RUWS* Work Vehicle moved freely at the end of an 850-foot neutrally buoyant flexible tether deployed from the PCT (Figure 70a). In addition to launch and recovery of the *RUWS* vehicle, other functions of the PCT were to maintain tension in the primary cable and provide position-keeping capability for its bottom end.²² A third key component was the Motion Compensating Deck Handling System (MCDHS), a versatile combination of launch crane and cable reel (Figure 70b). Its purpose was to launch and recover the *RUWS*/PCT combination and tend the primary cable, minimizing ship-induced motion and tension therein.

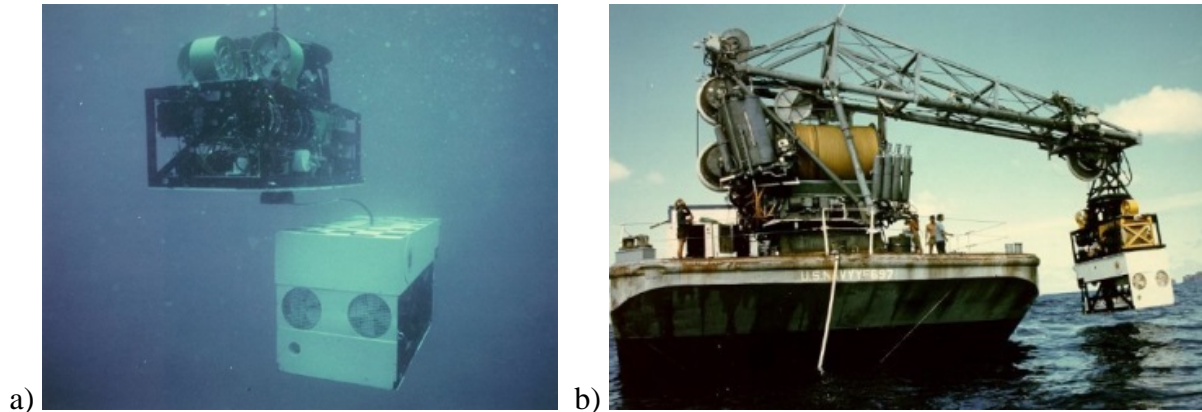

Figure 70. a) The *RUWS* Work Vehicle (bottom right) moved freely at the end of a buoyant flexible tether deployed from the Primary Cable Termination (PCT) component (upper left). b) The MCDHS with *RUWS* attached beneath the PCT could operate in sea-state three and perform recovery in sea-state four.

A seven-function hydraulic master–slave arm was terminus controlled by the operator moving a simple pistol grip to vary the position and orientation of the remote manipulator (Figure 71a). Force-feedback allowed any resistance encountered by the remote arm to be reproduced at a scaled-down level in the master arm, and thus felt by the operator. A second simpler and more rugged four-function gripper arm was used to steady *RUWS* to the workpiece or worksite. An artist’s concept of the *Work System Package (WSP)* mounted on the manned submersible *Alvin* is shown in Figure 71b (Wernli, 1979).

²² In effect, the *PCT* was a sophisticated plumb bob, keeping the main umbilical section vertical and isolating the *RUWS* work vehicle from its motions.

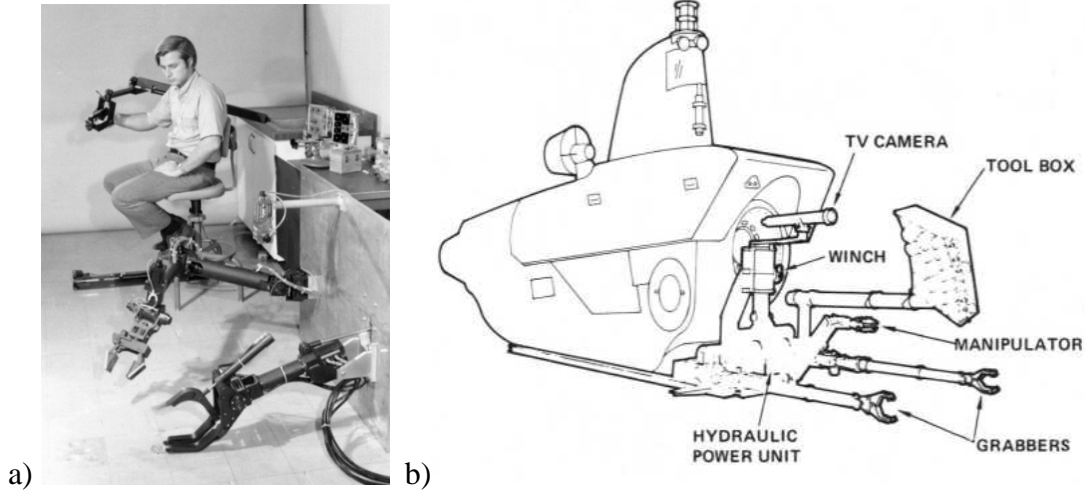

Figure 71. a) In this land-based training mockup, Jim Held (background) manipulates the 7-function master input device to control the slave (center), with the more simplistic gripper arm used for workpiece stabilization at foreground right. b) The *WSP* as it would appear mounted on the manned submersible *Alvin* (Wernli, 1979).

Following 6 weeks of operational testing with the *Cable Controlled Underwater Recovery Vehicle (CURV III)* at San Clemente Island off California in 1976 (Wernli, 1980),²³ the *WSP* application payload was flown to the NOSC Hawaii Laboratory for integration onto *RUWS*. Further test pool evaluation followed in preparation for supporting the upcoming *Large Object Salvage System (LOSS)* operational demonstration at the Naval Coastal Systems Center (NCSC). The *WSP/RUWS* combination was then flown to Panama City, FL, where it successfully supported *LOSS* demonstrations during 1976 and 1977 (Wernli, 1979).



Figure 72. After recovering wreckage from the *Space Shuttle Challenger* disaster in January 1986, *CURV III* was transferred to the Navy Supervisor of Salvage (SUPSALV) and upgraded for operations down to 20,000 feet. The rugged and enduring unmanned undersea system was still operational almost 30 years later.

²³ A full account of this testing is provided in NOSC *Technical Report 553*, available from the Defense Technical Information Center (DTIC) (Wernli, 1980).

The *WSP* payload was then returned to San Diego where it underwent an extensive laboratory evaluation of the operating characteristics, resulting in a complete time-motion baseline description of the system. The payload was further studied for integration onto the *Pontoon Implacement Vehicle (PIV)* for deep ocean recovery (Wernli, 1979). Ironically, the *RUWS* work vehicle was lost at sea in January 1980 due to a design flaw in its mechanical attachment to the PCT, and subsequent search and recovery efforts proved futile due to the extremely rough scarp bottom.

CHRONOLOGICAL PROJECT SUMMARIES (1980–1989)

ROBART I(1980–1982)

One of the very first behavior-based autonomous robots (Figure 73a), *ROBART I* was then Lieutenant Commander Bart Everett's thesis project at the Naval Postgraduate School (NPS) in Monterey, CA (Everett, 1982a; 1982b). This robotic security system was rather unique at the time in that it was fully autonomous with no RF link or operator control unit (OCU); human input was normally limited to a single toggle switch that enabled/disabled the Security Assessment mode (Figure 73b). If needed, a small troubleshooting panel with four toggle switches and a pushbutton for speech-prompted binary entry of two four-bit nibbles could be used to invoke various diagnostic routines (Figure 73b). Output responses were conveyed via speech synthesis using the newly introduced National Semiconductor *DigiTalker* board.

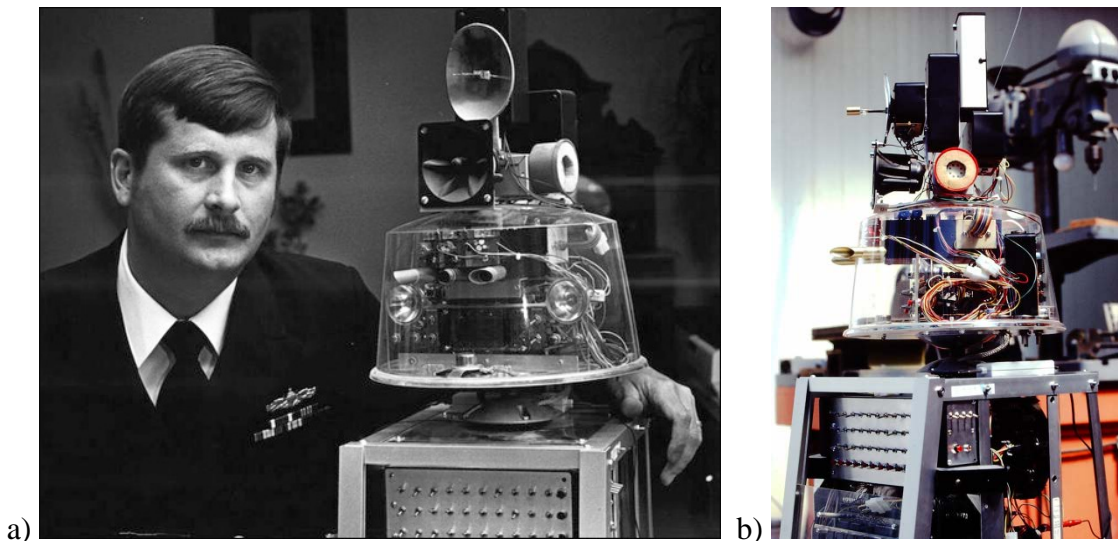

Figure 73. a) Lieutenant Commander Bart Everett, USN, poses with *ROBART I* during filming for *ABC World News Tonight* while attending the Naval Postgraduate School in Monterey, CA, circa 1982. b) The four-bit troubleshooting panel is on the left side of the robot at bottom center.

The robot's mission was to patrol a home environment, following either a random or somewhat predetermined pattern from room to room, checking for unwanted conditions such as fire, smoke, flooding, or intrusion. The security application was chosen because it demonstrated performance of a useful function that did not require an end-effector or vision system. Patrols were made at random intervals, with the majority of time spent immobile in Security Assessment Mode to conserve power and enable detection, as the on-board motion sensors could only work properly when the robotic platform was not moving (Everett, 1980).

One exception was the head-mounted passive-infrared (PIR) motion detector made by Colorado Electro-Optics, which had a maximum range of about 50 feet indoors (Everett, 1982b):

“This unit is intended to be mounted in a stationary position, but was found to be stable enough in an average household-temperature environment to operate when the vehicle was in motion, due to the low speed of advance ...”

“If the head is turned to one side as the vehicle is moving, the presence of an intruder on that side will be detected due to relative motion with respect to the vehicle. An obvious advantage would therefore be realized by mounting a detector on each side of the vehicle, in addition to the one mounted on the head.”

This demonstration of human-presence detection from a moving robot, which for years since has been the Holy Grail of physical-security applications, worked only indoors at very slow speed.²⁴

In addition to the above PIR, optical, ultrasonic, and hearing sensors were used to detect intruder motion, with other sensors monitoring for vibration, fire, smoke, toxic gas, and flooding (Everett, 1982a). Some of these inputs were hard-wired to cause a security alert, whereas others had to be evaluated first by software that could then trigger an alert if warranted. Operational feedback regarding the pros and cons of this approach led to the vastly improved security-assessment algorithm later developed on *ROBART II*, as alluded to at the time by Everett (1982b):

“As the software is developed for the intrusion-detection scheme employed by the robot, it soon becomes apparent that in most environments confirming information from other sensors should be obtained to minimize false alarms.”

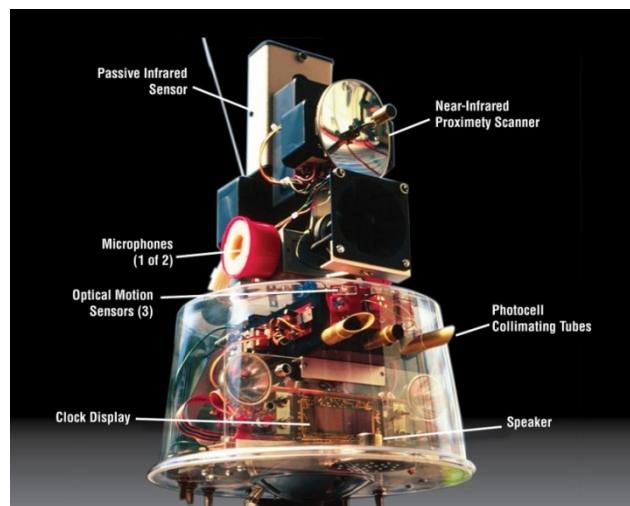

Figure 74. Intruder-detection sensors on *ROBART I* included a passive-infrared motion sensor at the very top of the head, three optical motion sensors immediately above the beacon-tracking collimating tubes on the front face, two microphones for ears, and a vibration sensor in the torso (not shown).

²⁴ Note that this configuration would detect any discreet thermal source such as a stove burner, and not just humans. See chronological Project Summaries section in Volume 2 for *Human Presence Detection* and *Human Presence Detection and Assessment*.

ROBART I was powered by a 12-volt, 20-amphour lead-acid battery that gave about 6 hours of continuous service before initiation of automatic recharging. A 1-hour power reserve was allocated for locating an optical homing beacon atop the charging station after the battery-monitor circuit detected a low-voltage condition. The origins of this phototropic behavior dated back to the *Crawler* (Figure 75a), an autonomous tracked robot Everett built in 1965 as a high-school science-fair project (Everett, 1995a; Davis, 2011).²⁵ The rotating collimating-tube orientation relative to vehicle front-center whenever the beacon was sensed by the tube photocell determined which drive track to stop and for how long during each scan revolution (Figure 75b).

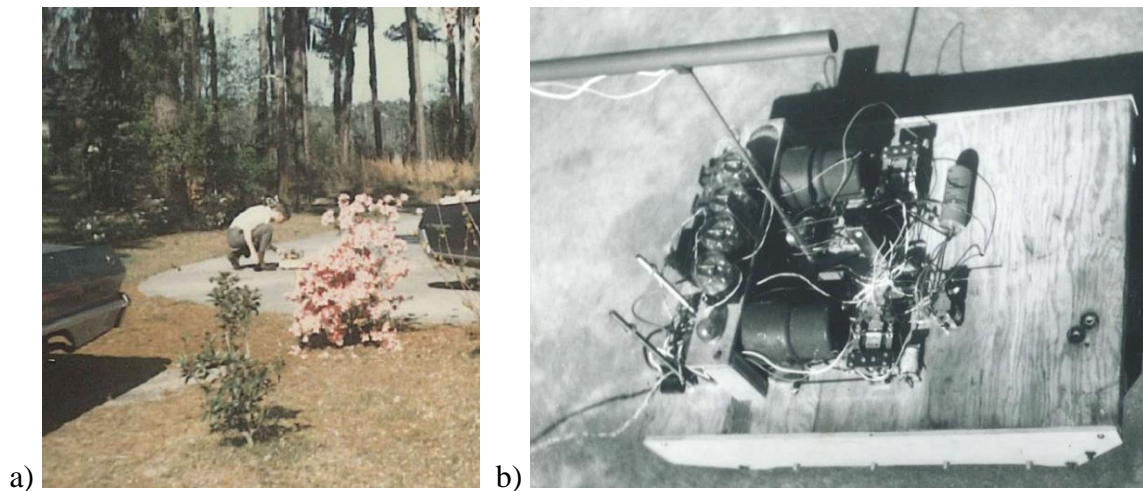

Figure 75. a) *CRAWLER I*, circa 1965, was an autonomous tracked robot with a rotating photocell scanner that enabled a phototropic homing response for recharging. b) Once beacon detection by the photocell coincided with the collimating tube passing through vehicle front-center as shown, corrective steering was inhibited with the robot pointed directly at the charger.

The improved beacon-tracking system on *ROBART I* some 16 years later employed a three-element photocell array to automatically keep the head pointed at the beacon (Figure 76a), so the head pan angle could be used to position the steerable front-wheel for homing. The free-standing recharger beacon was initially located by panning the head through its full extent of travel while digitizing the perceived light level as a function of the pan-axis encoder value. The optical beacon on the charger was then activated using a garage-door-type RF link, after which another full scan was performed. Assuming the recharging station was within the surveyed area of regard, subtracting these two linear arrays yielded a peak intensity differential corresponding to the beacon's relative bearing (Figure 76b).

²⁵ The *Crawler* robot was intended for entry in the 1967 science fair, unfortunately the same year this long-standing annual event was discontinued by the faculty at Moultrie High School in Mt. Pleasant, SC.

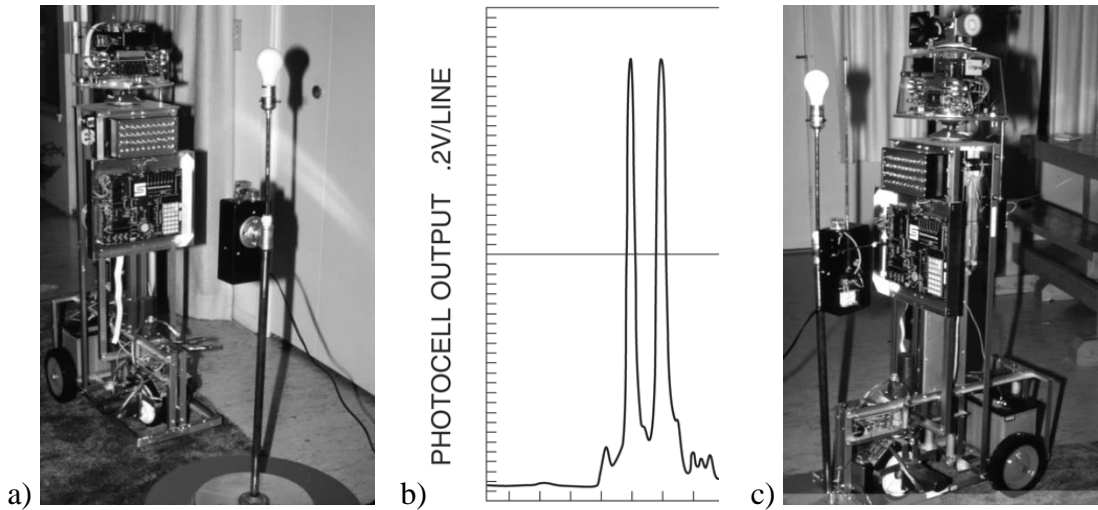

Figure 76. a) This early 1981 version of *ROBERT I* has activated the optical beacon on its recharging station and is preparing to dock. b) Analog photocell output as a function of scan angle. c) Shown here several months later with the head covered, the robot has docked with the recharging station, but not yet deactivated the optical beacon.

If no beacon was sensed, the robot turned 180 degrees to repeat the scanning process. Once beacon acquisition was confirmed, the Dock behavior (Table 2) slaved the front-wheel steering actuator to the head position during forward travel. The metal pole supporting the homing beacon served as the ground (GND) contact for the charging circuit, its mating surface being the spring-loaded front-bumper panel. The connection for the HOT leg was through a circular aluminum plate at the base of the beacon tower, which was electrically isolated from the vertical pole by a Plexiglas insulator (see Figure 76a). The spring probes that mated with this plate extended downward from a small plastic box attached to the drive-wheel support cage (Figure 77).

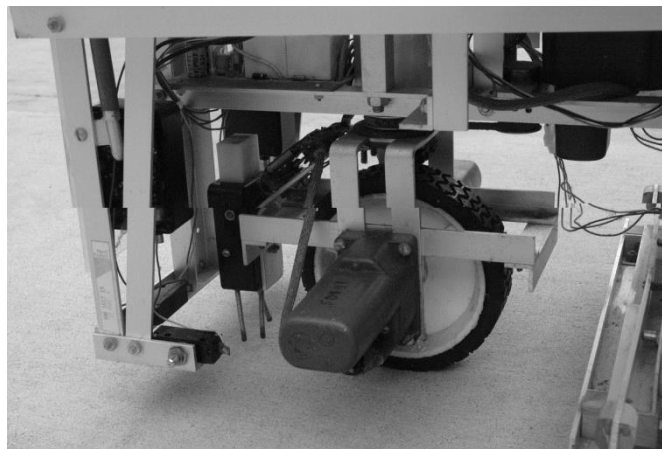

Figure 77. Tandem drive motors were attached to each side of the front wheel for forward and reverse motion, while a third motor situated above provided ± 80 degrees of steering angle. The three springs descending from the small black box attached to the drive-wheel assembly made contact with the circular plate on the recharger base.

ROBERT I's autonomous-navigation scheme featured a layered hierarchy of behaviors (Table 2) that looked ahead for a clear path (high-level), reactively avoided nearby obstacles (intermediate-

level), and responded to actual impacts (low-level). A basic tenet of this strategy was the ability of certain high-level deliberative behaviors to influence or even inhibit the intermediate and low-level reactive behaviors, such as disabling collision avoidance just prior to docking with the recharging station. All on-board processing was performed on a 1-mHz Synertek *SYM-1* single-board computer with just 36 kilobytes of RAM, programmed in 6502 assembly language.

Table 2. The layered behavior structure employed on *ROBART I* for autonomous navigation and collision avoidance allowed certain high-level deliberative behaviors to influence or even disable intermediate and low-level reactive behaviors.

Level	Behavior	Resulting Action
High	Radar Survey Dock	Look ahead for potential obstacles Look for opening in forward hemisphere Home on recharging-station beacon
Intermediate	Wander Wall Hugging	Seek clear path along new heading Follow adjacent wall in close proximity
Low	Proximity Reaction Impact Reaction	Veer away from close proximity Veer away from physical contact

In support of the high-level Radar and Survey behaviors, a custom-designed near-infrared proximity sensor mounted on the head provided reliable detection of diffuse wall surfaces for ranges out to about 6 feet (Figure 78). Lateral resolution was sufficient to reliably locate the edge of an open doorway to within 1 inch of arc at 5 feet (Everett, 1982). No distance-measurement capability was provided, however, other than any detected target was somewhere within the effective range of approximately 6 feet. This sensor, which could be reoriented up to 100 degrees on either side of centerline by panning the head, was extremely useful in locating open doors and clear zones for travel.

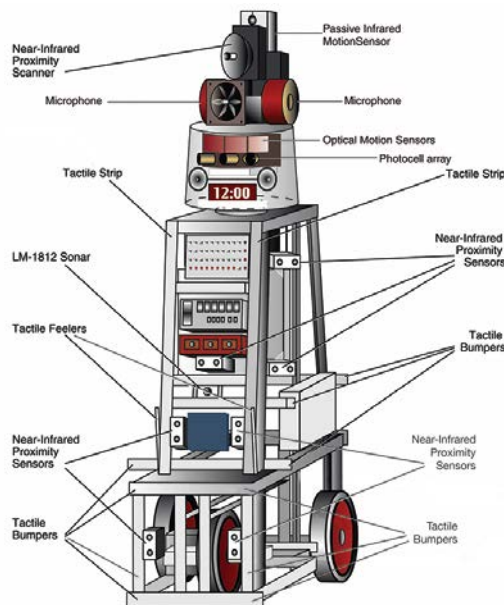

Figure 78. *ROBART I* was generously equipped with a variety of proximity sensors, feeler probes, tactile bumpers, and an *LM-1812*-based sonar for obstacle detection and avoidance (Everett, 2005). The parabolic reflector at top was part of a custom near-infrared scanner used to detect open doorways and unobstructed areas for forward transit.

The navigational behaviors outlined in Table 2 collectively supported the robot's hallway-navigation scheme (Davis, 2011), aided by the recharger beacon being suitably positioned to assist the robot in finding the hallway (Figure 79). Once in the hall, the robot would move parallel to the walls in a reflexive fashion, guided by 10 short-range, near-infrared proximity sensors on the front and sides (see Figure 78), plus the previously discussed head-mounted proximity scanner. General orientation in the hallway could be determined from which direction afforded a view of the beacon. With an a priori linked-list representation of where the rooms were situated relative to this hallway, the robot could proceed to any given room by simply counting off the correct number of open doorways on the appropriate side (Everett, 1996).

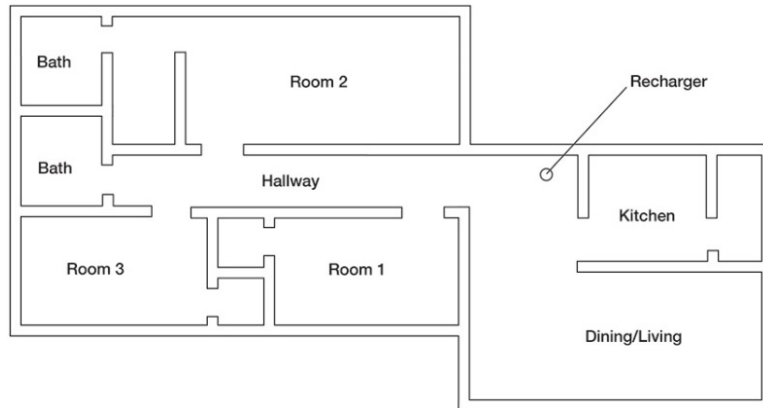

Figure 79. General floor plan (recalled from memory) of the Everett residence on Rickett's Road in Monterey, CA, showing the recharging station (small circle) at the right-most end of the hallway (Everett, 2005). The beacon on the recharger could be remotely activated by the robot to serve as a navigational aid.

The side-looking proximity sensors (see Figure 78), with maximum range set to about 16 inches, kept the wandering robot reasonably centered while transiting the 3-foot-wide hallway. The room-entry behavior was tuned by trial-and-error adjustment of head scan angle θ for doorway detection (Figure 80). Insufficient head deflection would cause premature detection, resulting in the robot turning too soon, while too much deflection (θ_1) caused the robot to turn too late. The forward-looking proximity sensors enabled last minute heading adjustments as needed to ensure collision-free doorway penetration. All proximity sensors prevented the robot from entering congested spaces, as for example through the open doorway of a small closet.

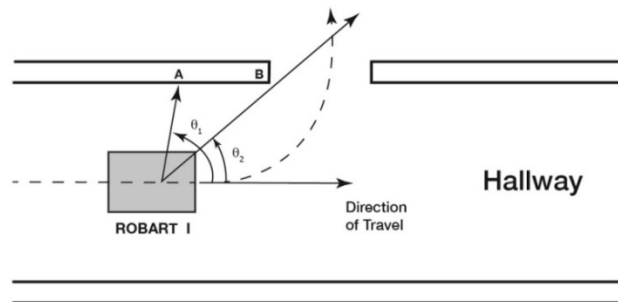

Figure 80. Turn initiation was tuned by varying head scan angle θ . For θ_2 , the head-mounted proximity sensor has just detected the door opening at wall position B , which will result in the optimal arc shown by the dashed line.

Intended as a simplistic demonstration of technical feasibility, *ROBART I* was built on a limited budget, funded by Lieutenant Commander Everett with approximately \$8000 of his own money. This philosophy assumed that if the security-robot concept could be successfully implemented under such primitive development strategies, a reasonable extrapolation would show significant promise for a more sophisticated second-generation version. The success of this approach started a media frenzy that led to Everett's assignment in November 1982 as special assistant for Robotics to Vice Admiral Earl Fowler, Commander, Naval Sea Systems Command, in Washington, DC (Appendix C) (Newton, 2006; Davis, 2011). The Naval Postgraduate School's Public Affairs Officer relocated for a week to the Everett household to answer the phone, which rang again almost as soon as it was hung up (Davis, 2011).

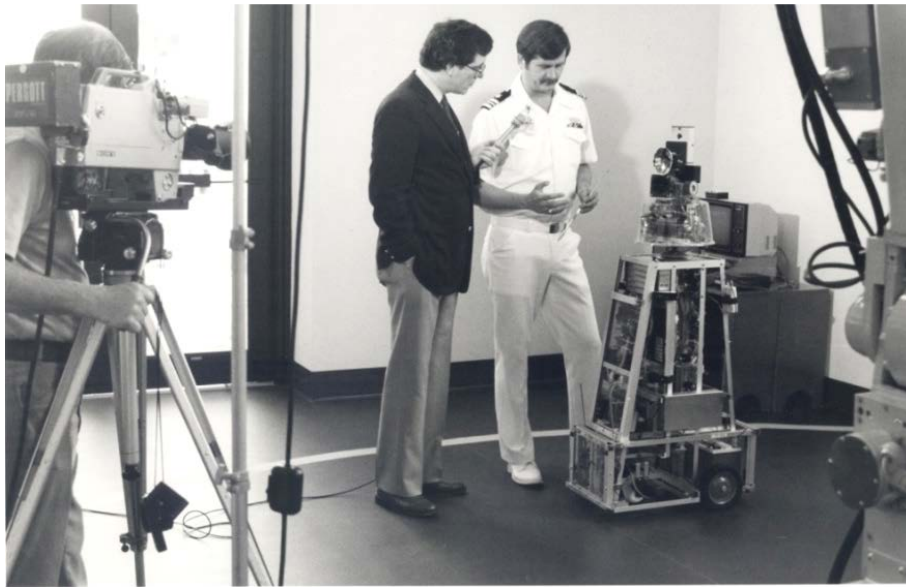

Figure 81. Lieutenant Commander Everett explains the perception sensors supporting *ROBART I* to a television reporter at the new Robotics Lab, NSWC White Oak. The robot played a prominent role in numerous demonstrations at this facility from 1983 through 1985, when it was showcased at *Expo '86* in Vancouver, BC.

Early the following year, *ROBART I* was loaned to the Naval Surface Weapons Center (NSWC), White Oak, MD (Figure 81), entrusted to the watchful care of MIT AI Lab co-op student Anita Flynn (Figure 82), a later pioneer in the field of micro-robotics. Towards the end of 1985, *ROBART I* was shipped from NSWC to Vancouver, BC, for yearlong exhibition in the *Design 2000* pavilion at the *EXPO '86* world's fair (Davis, 2011). The well-traveled feasibility prototype was returned to Everett at NOSC in 1987, where it ultimately became a static display alongside its relatives in the museum area of Building 624, Seaside.

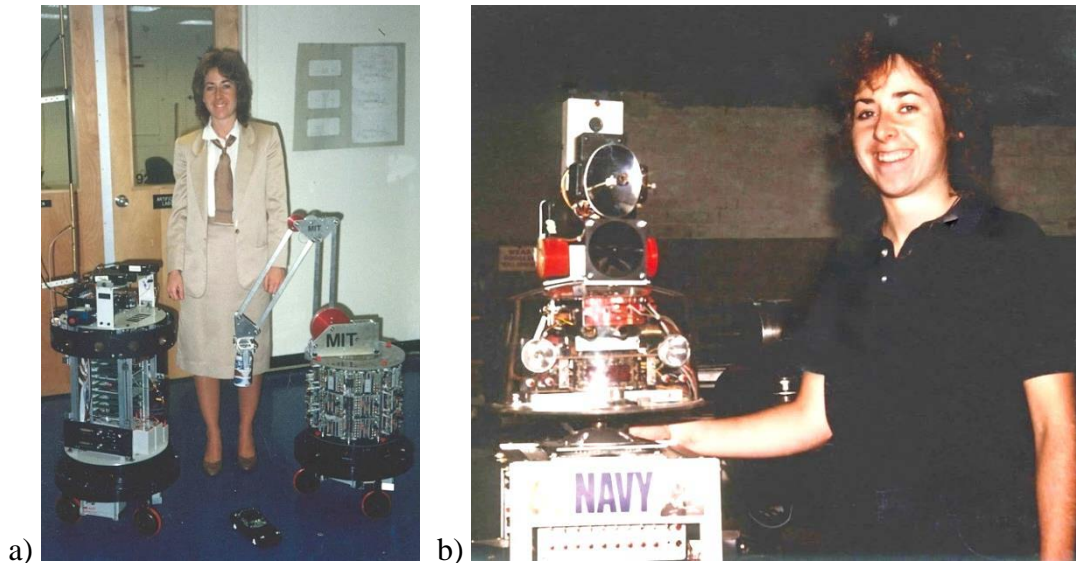

Figure 82. a) Co-op student Anita Flynn with two of her robots at the MIT AI Lab. b) Ms. Flynn took charge of *ROBART I* at the NSWC Robotics Lab, White Oak, MD (Davis, 2011), and often worked nights and weekends in Everett’s basement assisting with software development and testing of *ROBART II* (see later section).

Ground Surveillance Robot (1981–1987)

Funded by the USMC, the previously mentioned *Ground Surveillance Robot (GSR)* project explored the development of a modular and flexible distributed architecture for the integration and control of complex robotic systems (Harmon, 1982; Aviles, Gage, Harmon, & Bianchini, 1985). The 7-ton Vietnam-War-era *M-114 Command and Reconnaissance Carrier* donated by the Army Research Laboratory (ARL) was outfitted by the Unmanned Systems Branch (Code 442) to serve as a fully actuated vehicle testbed (Figure 83). The long-term goal of this 6.2 USMC program was to explore a number of identified issues for military UGV applications, such as reliability, security, and multi-robot coordination (Harmon & Gage, 1984).

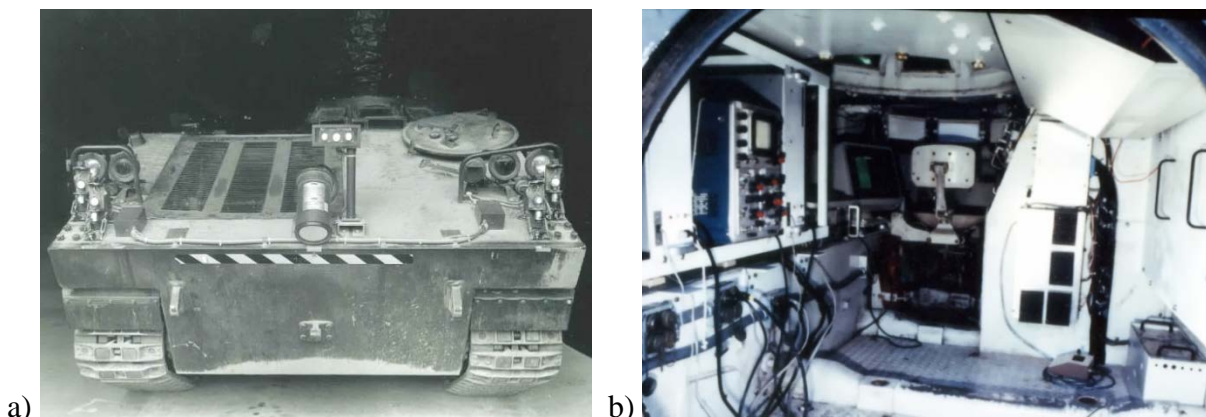

Figure 83. a) The *GSR* was equipped with an array of fixed and steerable ultrasonic sensors for following a lead vehicle or pedestrian, plus an agricultural John Deere Doppler ground-speed sensor (photo center). b) The *GSR* interior offered ample space for a network of IBM Personal Computers, circa 1985.

From an operational perspective, the *GSR* was intended to transit from a known geographic location to a designated destination over unknown natural terrain (Harmon, 1986):

“Although the *GSR* must develop a map of the terrain from its starting point to its goal and plan its route from that information alone, it must also improve its performance by using a computerized terrain map of the appropriate territory if available.”

The *GSR* also had to avoid obstacles while in transit, as further explained by Harmon (1987a):

“Obstacle avoidance capability has been implemented by fusing information from vision and acoustic ranging sensors into local goals and avoidance points. The influence of these points is combined through potential field techniques to accomplish obstacle avoidance control. Distant terrain characteristics are identified using information from a gray-level vision system, a color vision system, and a computer-controlled laser ranging sensor.”

The laser rangefinder is shown in Figure 84a, with a close-up of the video sensors in Figure 84b.

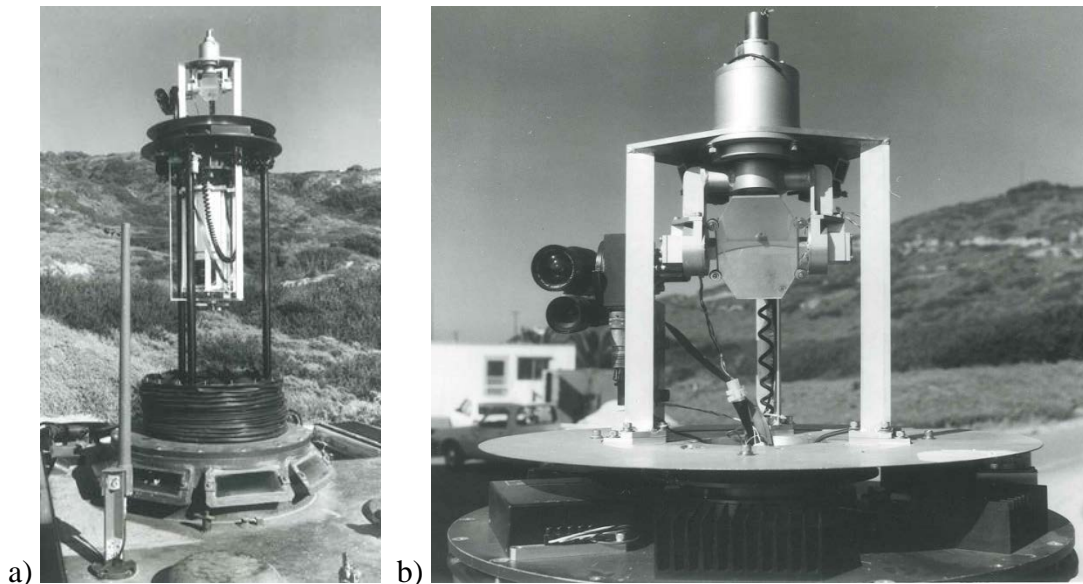

Figure 84. a) A key component of *GSR* development was an upward facing laser rangefinder mounted beneath a 3-DOF (degree-of-freedom) articulated mirror for redirecting the beam, and a lead-screw lift mechanism for elevation. b) The color and monochrome vision cameras were mounted adjacent to the mirror assembly. Note office trailer in background left.

The vehicle perception, planning, and control subsystems were coordinated via a distributed-blackboard architecture implemented on multiple PCs as shown in Figure 85 (Harmon et al., 1986). Terrain features identified by the video sensors and reasonably located by the laser were to be used by a planning engine to determine an appropriate path to some visible waypoint in the direction of the final goal (Harmon, 1987a). This intuitive process, which closely imitated how a human might navigate cross country, was to be repeated in iterative fashion to generate a succession of vehicle movements from waypoint to waypoint to reach the intended destination.

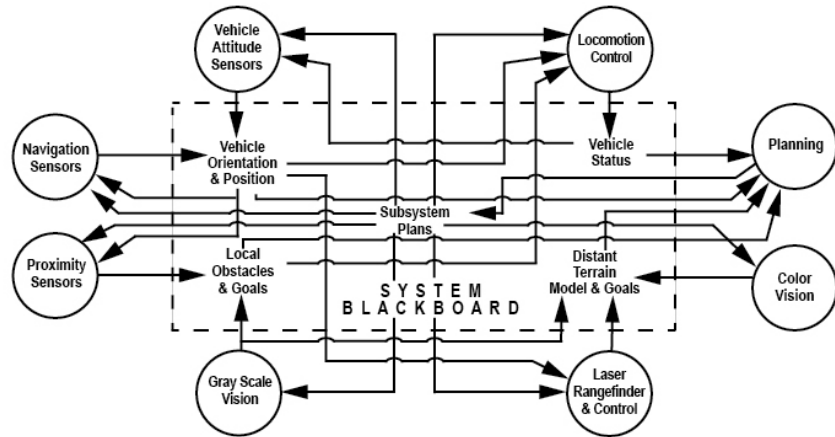

Figure 85. Blackboard model of subsystem interaction (adapted from Harmon, 1986). The camera and laser navigation sensors, for example, had to interact in building a terrain map by using the camera-generated contrast map to guide discrete spatial sampling performed by the laser rangefinder (Harmon, 1987b).

Since this was one of the first pioneering attempts at autonomous navigation in exterior environments, there understandably were many practical problems hampering successful implementation at the time. Key deficiencies were adequate sensor subsystems that could effectively perceive the environment, as well as more accurate vehicle localization subsystems that could georeference the acquired perception data in absolute coordinates. As summarized by Harmon (1987a):

“The experience from implementing this autonomous vehicle has indicated the need for an integrated set of debugging tools which make the faults in subsystem hardware and software more distinguishable.”

Using monochromatic vision and both fixed and steerable ultrasonic sensors, the *GSR* did successfully demonstrate autonomous following of both a lead vehicle and a walking human in 1986 (Gage, 1995b). Considerable work remained, however, to achieve point-to-point autonomous navigation. Overshadowed by DARPA’s longer term *Autonomous Land Vehicle (ALV)* program (DARPA, 1986), the much smaller *GSR* effort was terminated the following year by the USMC to better focus limited funding on nearer term teleoperated solutions. Development status at this time was graphically depicted by Harmon (1987b) in Figure 86.

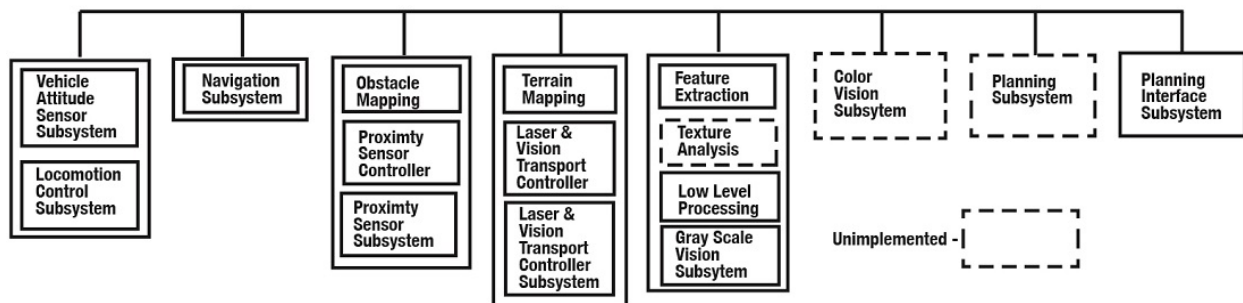

Figure 86. While the *GSR* blackboard (Figure 85) was tree-structured, the functional level was monolithic, which allowed subsystems to interact without architecturally imposed limitations (redrawn from Harmon, 1987b). The Texture Analysis, Color Vision, Planning, and Planning Interface subsystems at right were never implemented.

Remote-Presence Demonstration System (1981–1985)

Intended to support development and demonstration of remote-presence technology, the *Remote Presence Demonstration System* (nicknamed “Green Man”) was a hydraulically actuated anthropomorphic master–slave configuration that remotely mimicked the upper torso of a human operator.²⁶ The early prototype shown in Figure 87a was assembled in 1983 using a pair of MB Associates arms and a NOSC-developed torso and head.²⁷ The 1985 version in Figure 87b provided additional degrees of freedom at the hip, torso, shoulder, and arms (Umeda, 2015), and featured an exoskeletal master controller with kinematic equivalency and spatial correspondence of the torso, arms, and head.

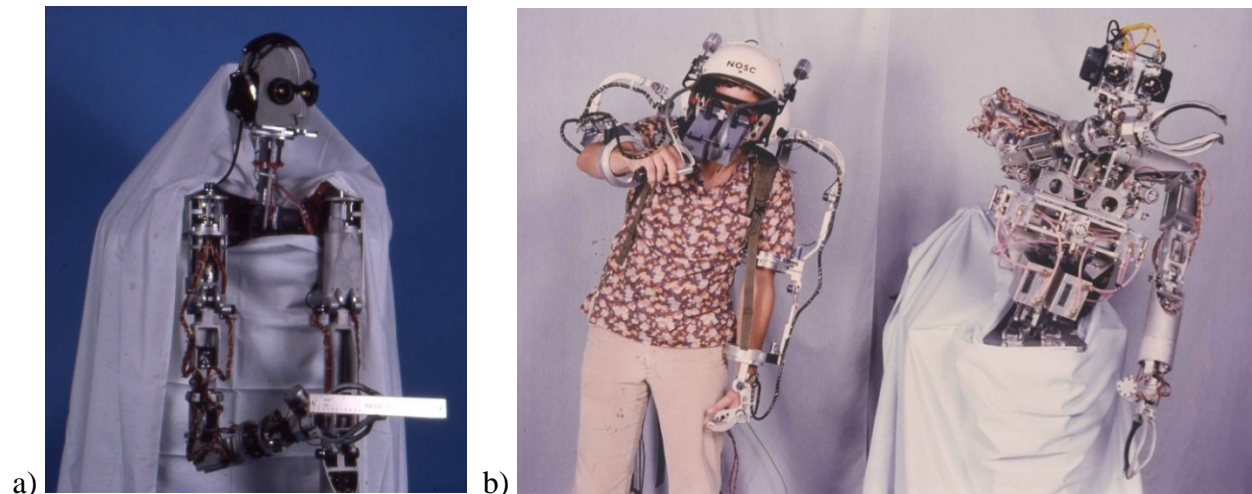

Figure 87. a) Early “Green Man” prototype, circa 1983. b) Developed by Code 53 at the NOSC Hawaii Laboratory, this 1985 version (right) mimics the head and torso movements of operator Dave Smith (left). The stereo cameras on this configuration were integrated by avionics contractor Teledyne (Umeda, 2015).

“Green Man’s” stereo-vision system, two 525-line, 35-degree field-of-view video cameras and a corresponding pair of video-camera eyepiece monitors mounted on an aviator’s helmet, provided valuable experience in telepresence design. Even with the simplistic claw hands and no force or tactile feedback, novice operators could readily perform manipulative tasks without extensive training. Continued testing, however, clearly showed that more dexterous manipulators, force feedback, and a high-resolution vision system were necessary for diver-equivalent functionality. The head-tracking/camera-pan-and-tilt actuation scheme, on the other hand, was successfully transitioned to the *Advanced Teleoperator Technology* “Dune Buggy” project, discussed in a later section.

²⁶ The name reportedly derives from the original color of the hydraulic fluid that was visible through the clear tubing, which was at some later point was changed to red.

²⁷ The arm was built in the 1970s by Carl Flattau of NOSC Code 531 and Herbert L. Mummery of M.B. Associates (Rosheim, 1994).

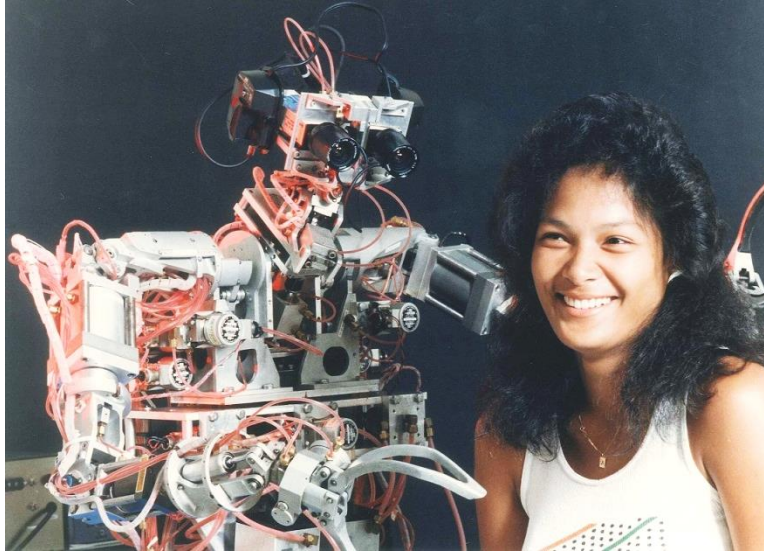

Figure 88. This August 1988 photo of the NOSC “Green Man” posing with student aid JoJo Aleo at the Hawaii Lab provides a close-up view of the wrist actuation scheme for the right arm.

With the closure of the NOSC Hawaii Laboratory in 1992, the “Green Man” system was shipped to NOSC in San Diego for storage, then transitioned the following year to Professor Morris Driels at the Naval Postgraduate School (NPS) in Monterey, CA (Chatfield, 1995). The underlying technology developed during the course of the Hawaii project was instrumental in scoping the follow-on NAVSEA-funded *Teleoperator/Telepresence System (TOPS)*, to be discussed in a later section (Rosheim, 1994).

ROBART II (1982-1992)

Having begun construction of *ROBART I* immediately upon arrival at the Naval Postgraduate School in 1980, Lieutenant Commander Everett finished his thesis at NPS several months early and began working on the second-generation *ROBART II* in mid-1982 (Figure 90). There were four general objectives:

1. Make the system more modular to facilitate maintenance and upgrades
2. Employ a parallel-processing hierarchy of distributed microprocessors (Figure 89)
3. Incorporate a more sophisticated mix of sensors in support of advanced autonomy
4. Provide a more finished look to the modular body structure

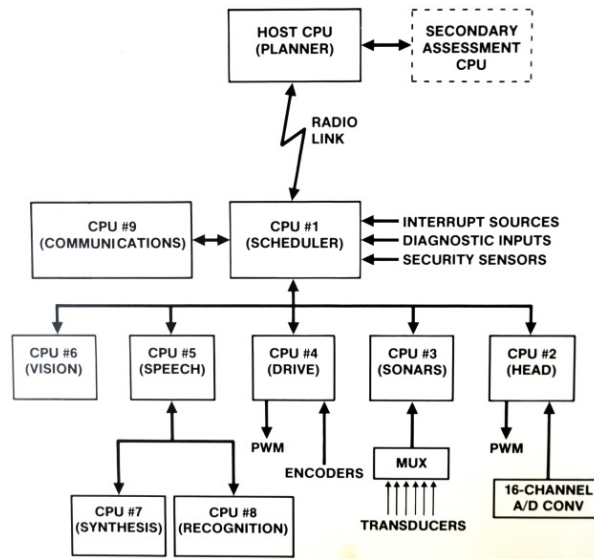

Figure 89. Block diagram of the computer architecture on *ROBERT II*, circa 1989. The number of on-board microprocessors was ultimately increased to 13 (Davis, 2011).

The physical structure of *ROBERT II* consisted of a cylindrical upper body that mated with a rectangular mobility base (Figure 90a), with a removable electronics cage serviced via a pair of access doors (Figure 90b&c). The upper housing was fashioned from a 30-inch section of 12-inch-diameter plastic pipe, with an acrylic cake cover supported by a Lazy-Susan bearing that formed the head pan axis. The initial mobility base was a functional plywood mockup fitted with a pair of A-BEC wheelchair motors, front and rear castors, and a lead-acid, gel-cell battery. Once the mobility design was optimized, this temporary plywood base was replaced by a hardened aluminum version with a black fiberglass shroud.

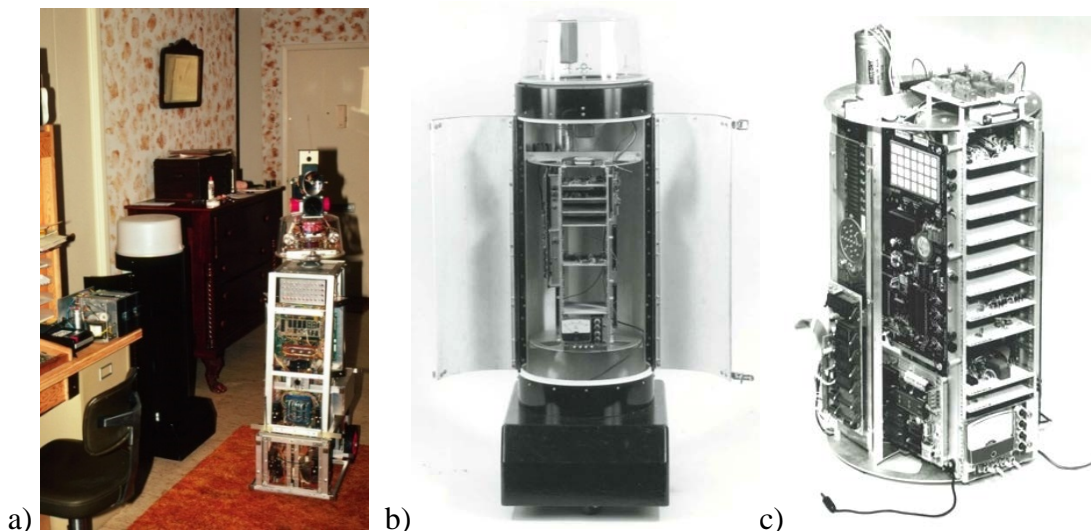

Figure 90. a) The initial instantiation of *ROBERT II* was a plastic-pipe housing on top of a functional plywood prototype of the mobility base, circa June 1982. b) Rear view showing computer cage and head pan assembly, circa August 1982. c) The computer module could be easily removed for maintenance (circa 1984).

Following Everett's reassignment to NAVSEA later that fall, the first of two distinct versions of *ROBART II* began to evolve in his basement workshop in Springfield, VA (Figure 91a), which consequently came to be known as the "Virginia version." This second-generation security robot performed essentially the same functions as its predecessor *ROBART I*, but with a multiprocessor architecture that enabled parallel real-time operations (Everett, 1985d). Improved performance was further addressed through significantly increased perception and more precise motion control, the latter supported by phase-quadrature optical encoders attached to the drive-motor armatures as shown in Figure 91b (Everett, 1985e).

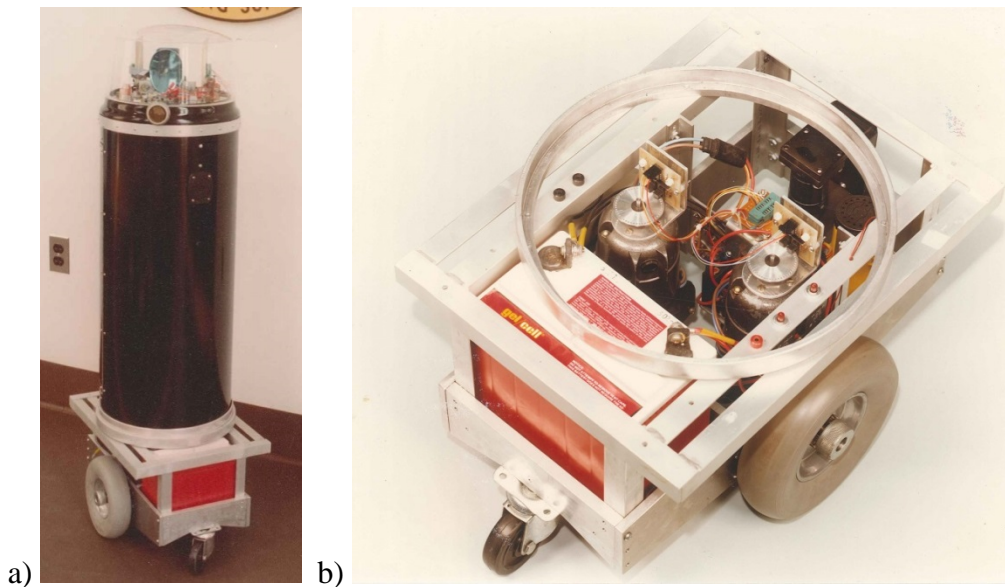

Figure 91. a) This early version of *ROBART II* at the Naval Surface Weapons Center (NSWC), White Oak, MD, was upgraded with an aluminum second-generation mobility base, circa 1983. b) Close-up view of the drive components, showing the optical shaft encoders retrofitted to a pair of A-BEC wheel-chair motors.

As shown at the far left in Figure 92, the collision-avoidance sensor suit was upgraded from that of *ROBART I* with the addition of a five-element Polaroid electrostatic sonar array, and a sixth sonar transducer mounted on the head (Everett, 1985). Note the partially installed tactile-bumper strip around the bottom of the mobility base. This evolving "Virginia version" of *ROBART II* was used by Anita Flynn to support her Master's thesis at MIT (Flynn, 1985; Everett & Flynn, 1986). Ms. Flynn worked alternate academic quarters during her undergraduate career in the NSWC Autonomous Systems Branch (Davis, 2011), then headed by Ms. Mary E. Lacey, later deputy assistant secretary of the Navy for Research, Development, Test and Evaluation.



Figure 92. Russ Werneth of NSWC and Lieutenant Commander Bart Everett of SEA-90G with *ROBART I*, *ROBART II*, and the *Odex* robot by Odetics at the NSWC Robotics Lab, circa 1985. Note the six gold Polaroid electrostatic sonar transducers on *ROBART II*, versus the single black piezoelectric transducer on *ROBART I*.

One of the more impressive autonomy demonstrations performed by *ROBART II* for visitors at the NSWC Robotics Lab was a robust person-following behavior. The sonar-transducer layout of Figure 92 helped discriminate a near-field human target from other reflective surfaces that should be avoided (see also Figure 93a). The sensor-fusion approach exploited the vertical aspect ratio of an erect human body in conjunction with perceived relative motion with respect to the robot. Lateral displacement of the human target detected by the bottom three transducers was used to proportionally adjust the robot's heading. This algorithm could reliably follow a moving human through a cluttered room and transit a narrow 28-inch doorway.

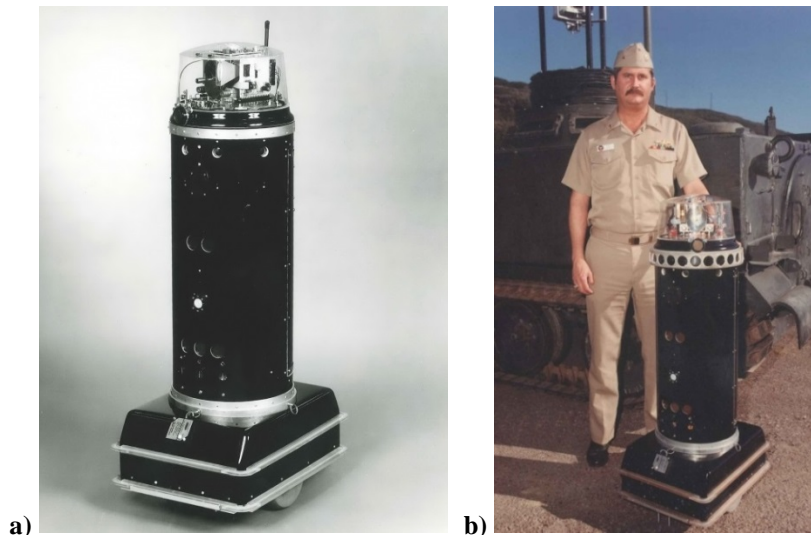

Figure 93. a) *ROBART II* at NSWC. Note Banner floor scanner for negative obstacles on the front of the base, and the two tactile bumper strips immediately below. *U.S. Patent No. 4,596,412* was issued to H.R. Everett and C.S. Wright for this bumper design on 24 June 1986. b) *ROBART II* upon arrival in San Diego, with the new fiberglass sonar-array housing in place just below the head for a fit check prior to transducer installation.

Following Everett's transfer to NOSC in 1986 (Figure 93b), the "California version" of *ROBART II* became a concept-development surrogate in support of indoor robot autonomy, with initial focus on two specific technology needs (Everett & Bianchini, 1987). The first of these addressed the navigational shortfalls identified by SEA 90G that were hindering successful implementation of a number of robotic applications requiring mobility (Gilbreath & Everett, 1988; Babb, 1990). To enable successful traversal of congested surroundings, the robot was upgraded with numerous proximity and ranging sensors for autonomous mapping, localization, collision avoidance, and navigational planning (Figure 94).

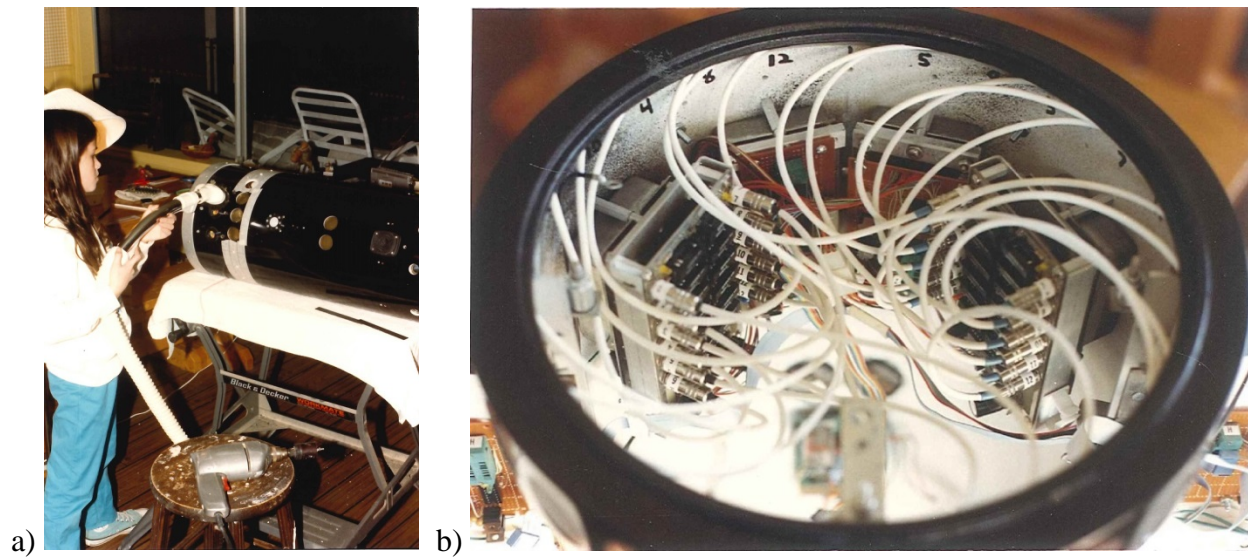

Figure 94. a) Rebecca Everett cleans up after her dad during the upgrade of *ROBART II*'s lower sonar array in their San Diego kitchen. b) Interior view of the cylindrical body housing with the head removed, showing the two 12-channel sonar multiplexors for the upper sonar array shown in Figure 93b.

Code 535 electrical engineer Gary Gilbreath chose a cell-based map representation for the robot's world model, with free space indicated by a cell value of zero (a non-zero value indicated occupancy). This approach offered the following advantages (Everett & Gilbreath, 1989):

- The operating area was a bounded interior space where a relatively coarse grid (i.e., 3-inch resolution) could be used (Figure 95).
- The traversability of a square could be statistically represented and easily changed.
- Objects of unknown configuration were easily added.
- A simple Lee maze router could be used for path planning (Lee, 1961).
- Unique coding of predefined entities (e.g., doorways, recharging station) was supported.

This early implementation of "augmented virtuality," wherein the battery-charger location and doorway status (open or closed) were reflected in the world model, was substantially augmented later under *ROBART III* (1992–2007).

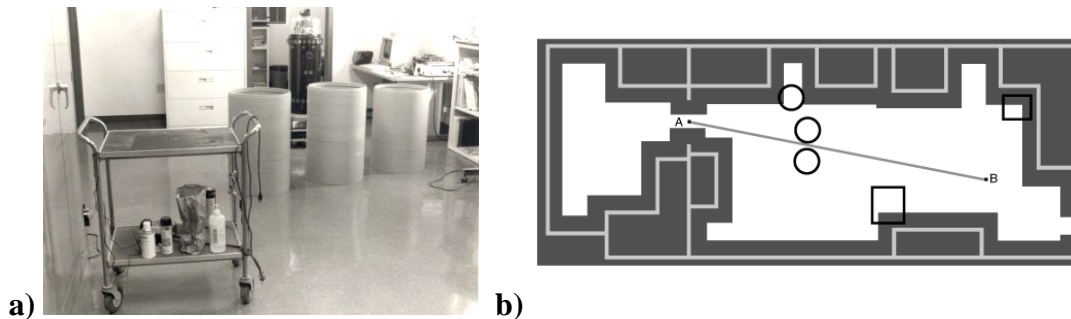

Figure 95. a) Photo of Room 102 in Building F-36, with *ROBART II* situated at Point A in the adjacent map representation of Figure 95b. b) Resulting straight-line path from position A to goal destination B, with overlaid circles and rectangles representing the X-Y locations of the as yet undetected transient objects shown in Figure 95a.

During the execution of this path segment, the collision-avoidance sonar array detected the row of cylinders (Figure 95) and began altering the associated cell probabilities to reflect the perceived obstructions. When the robot moved to within the collision threshold of 22 inches, forward motion was halted and newly mapped objects were temporarily grown for maneuvering clearance. This transient growth was removed after the new path segment was found (Figure 96a). The newly added dark-black areas represent the obstacles detected during the first move. Upon executing the revised path, the robot discovered the cart and planned another avoidance maneuver (Figure 96b).

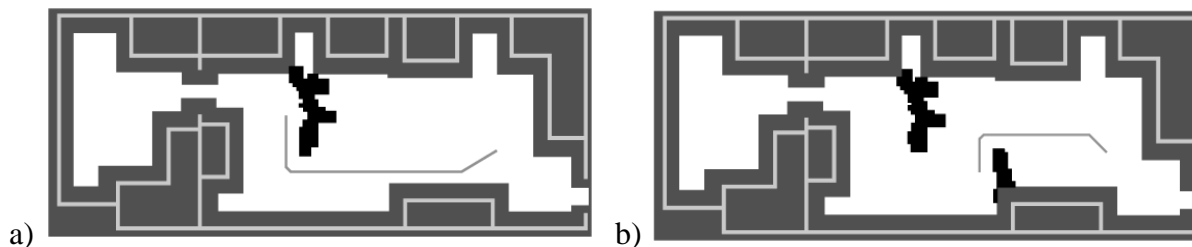

Figure 96. a) An avoidance maneuver was generated by the path planner to clear the row of cylinders shown in Figure 95a. b) Revised path from robot's new position to accommodate the discovery of the cart shown earlier in Figure 95a (adapted from Everett, Gilbreath, & Tran, 1990).

The improved battery charging station shown in Figure 97, compatible with the entire *ROBART* series, had been constructed in Virginia by Everett just prior to his 1986 transfer to the NOSC in San Diego, CA. As with *ROBART I*, the homing beacon was activated by a garage-door RF link, whereupon a current-limited sense voltage was applied to the recharging contacts so a valid connection could be perceived by the robot upon docking. The charging station also detected this connection and activated the battery-charger power supply after the mating contacts had debounced (Everett, Gilbreath, & Tran, 1990). *U.S. Patent No. 5,045,769* for an "Intelligent Battery Charging System" was awarded H. R. Everett on 3 September 1991.

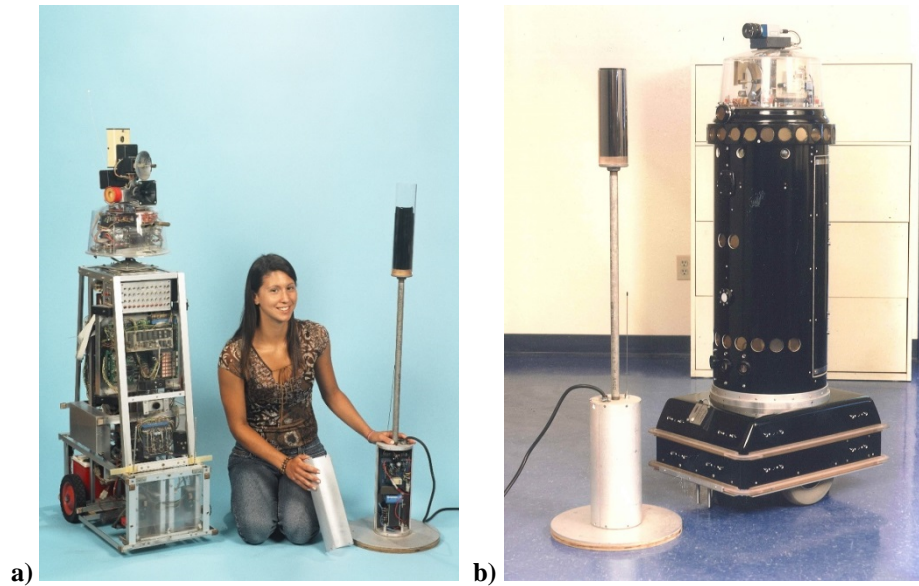

Figure 97. a) ONR summer intern Lisa Dakis with the new charger, compatible with the entire *ROBART* series. b) *ROBART II*'s head mounted sonar provided continuous range-to-beacon measurements during approach, while the collision-avoidance sonar array just above the mobility base detected obstacles to be added to the world model.

The second thrust was aimed at producing a robust automated security system exhibiting a high probability of detection, with the equally important ability to distinguish between actual and nuisance alarms (Everett, Gilbreath, & Alderson, 1988). *ROBART II* was already equipped with a multitude of environmental sensors that monitored system and room temperature, relative humidity, barometric pressure, ambient light, noise levels, toxic gas, smoke, and fire. Intrusion detection was addressed through the use of infrared, optical, ultrasonic, microwave, and video motion detection, as well as vibration monitoring and discriminatory hearing (Figure 98).

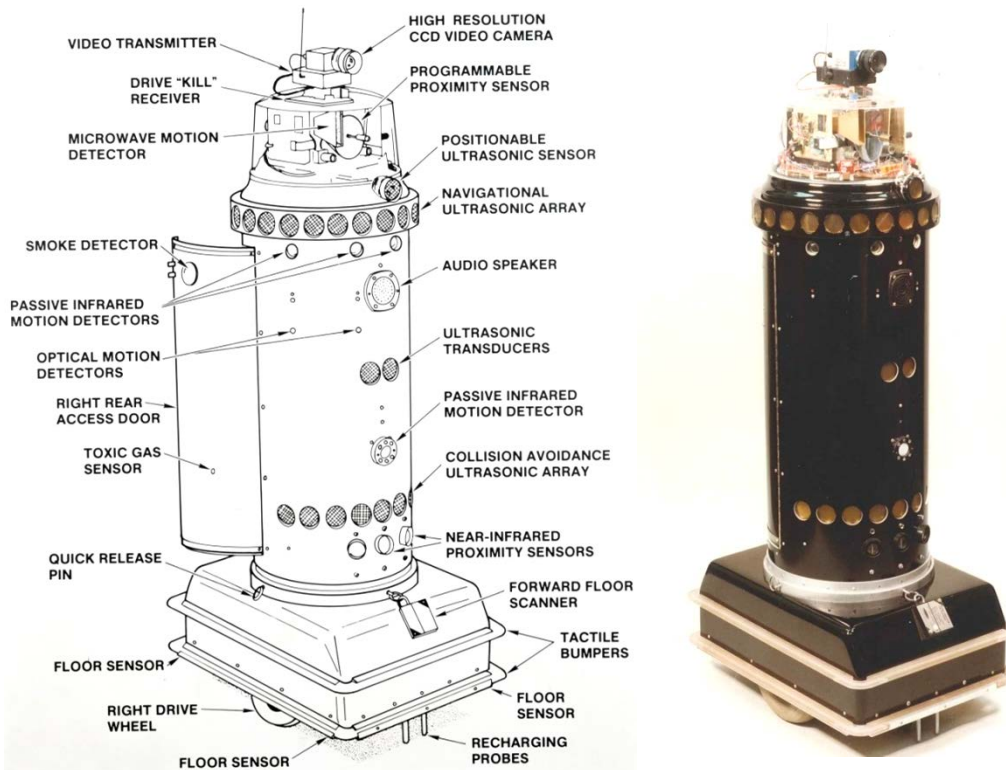

Figure 98. *ROBERT II* was equipped with an array of environmental, intrusion detection, and navigation sensors. The upgraded Polaroid sonar system featured 36 electrostatic transducers (versus the original six) in two separate arrays. The upper body easily detached from the mobility base upon removal of four quick-release pins.

To increase the probability of detection and reduce nuisance alarms, two new sensor modalities were added to the Intelligent Security Assessment System (Everett, Gilbreath, & Tran, 1990). A line-based video-motion-detection scheme allowed a 6502-based single-board computer to digitize any three horizontal lines of a composite video image (Figure 99). Developed by electrical engineer Theresa Tran, the software would monitor each of these lines for changes indicative of motion, reconfigure line selection to focus on suspected anomalies, then compare the perceived aspect ratio of the disturbance to a human target (Everett, Gilbreath, & Tran, 1990). *US Patent No. 5,034,817* for a “Reconfigurable Video Line Digitizer” was issued to H.R. Everett on 23 July 1991.²⁸

²⁸ Originally developed for *ROBERT II* in 1989, production versions of this system were installed on *ROBERT III* and the *MDARS-Interior* robot, both discussed in later sections.

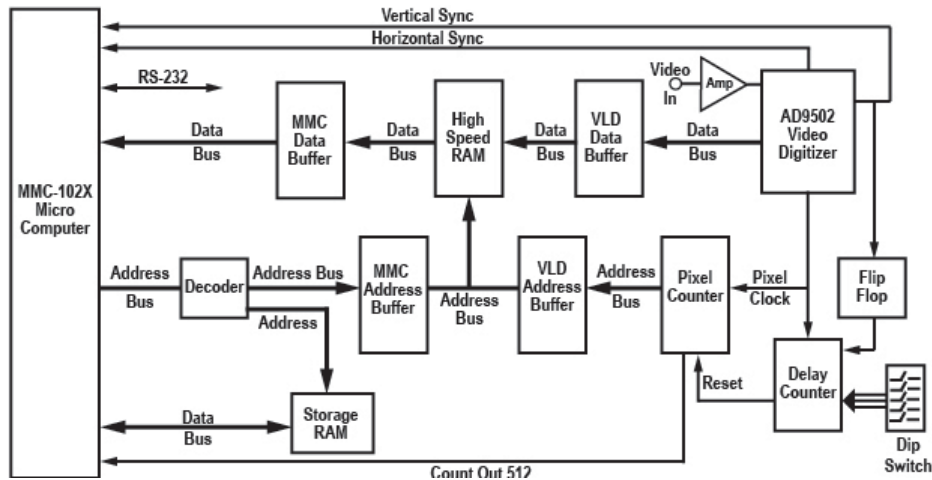

Figure 99. Block diagram of the 8-bit 6502-based “Reconfigurable Video Line Digitizer (VLD)” built by R.J. Brachman Associates, circa January 1990. This new sensor modality was activated in response to primary alerts to better discriminate between actual and nuisance alarms (Everett, Gilbreath, & Tran, 1990).

The second sensor upgrade was a directional head-mounted acoustic array that determined the relative bearing to the source of impulse noise such as breaking glass or a dropped object (Figure 100). The omnidirectional microphones and preamplifier stages were extracted from three Radio Shack baby monitors and coupled to operational-amplifier circuits configured as threshold comparators, the outputs of which were monitored by the software. The known array geometry and the time of detection for each microphone element would yield the direction to the source to within a few degrees, adding yet another data set for both temporal and spatial correlation (Everett, Gilbreath, & Tran, 1990). The 6502 software for this acoustic array was also written by Theresa Tran.

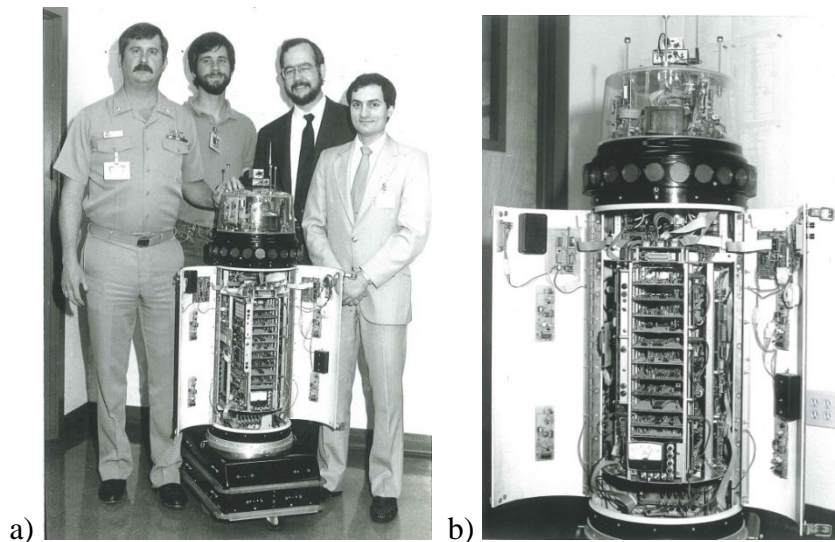

Figure 100. a) From left to right, Commander Bart Everett and Gary Gilbreath meet with John Holland of Cybermotion and Tim Papayianis of the U.S. Army Armament Research Development and Engineering Center regarding *ROBART II* technology of interest to the Army’s *Mobile Detection Assessment Response System (MDARS)*. b) Closer view of the head-mounted acoustic array for intruder detection (see also Figure 106a).

In addition to the basic smoke and gas sensors, seven different kinds of intrusion-detection modalities were ultimately employed on *ROBART II*, to include passive infrared, microwave, optical, vibration, acoustical, sonar, and video. Time-stamped sensor status as well as environmental conditions were displayed as shown in Figure 101, and could be overlaid on live video from the robot's camera (Smurlo & Everett, 1993). Written by Gary Gilbreath, all high-level planning and security-assessment software ran on a desktop *PC/AT* computer, connected to the remote vehicle via a 1200-baud Repco RF modem (Everett, Gilbreath, and Tran, 1990).

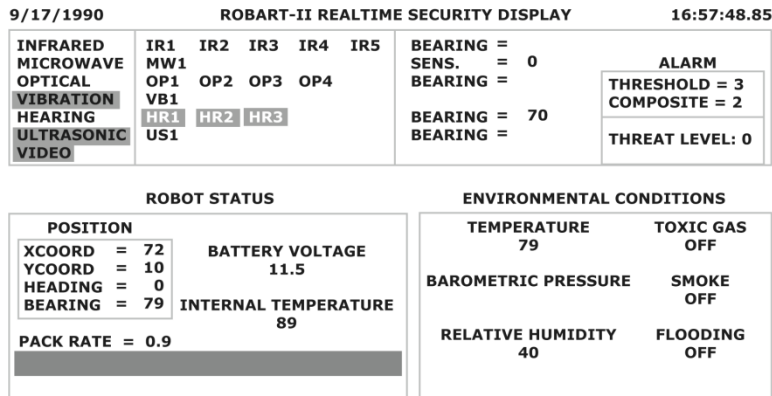

Figure 101. In the upper left-hand window of the Security Display, sensor modalities not currently active were depicted in reverse video (gray background). Just to the right, individual sensors within the active groups were portrayed in reverse video (light gray background) when alarmed (adapted from Everett, Gilbreath, and Tran, 1990).

The Intelligent Security Assessment System achieved a high probability of detection through fusion of a variety of motion-detection sensor outputs (Figure 102), while simultaneously reducing the nuisance-alarm rate through cross-correlation (Everett, Gilbreath, and Tran, 1990). The importance of this latter step became apparent in earlier work with *ROBART I* (Everett, 1980). Traditional fixed-installation security sensors can be optimally mounted within a building to minimize the chances of spurious interference, which is obviously not possible when installed upon a robotic platform that roams about. *U.S. Patent No. 4,857,912* for an “Intelligent Security Assessment System” was awarded to H.R. Everett and Gary Gilbreath for this concept on 15 August 1989.

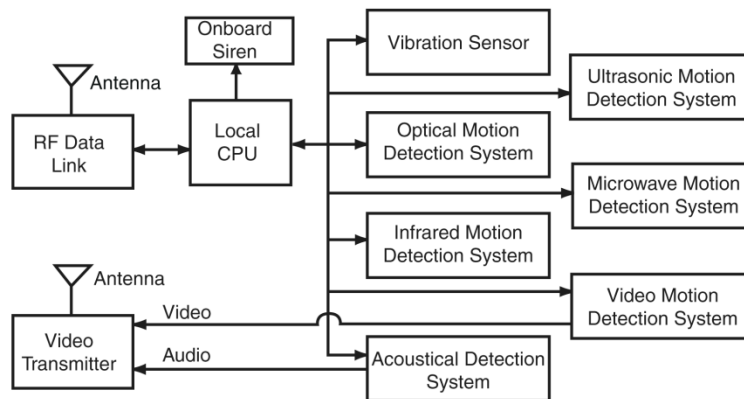

Figure 102. Block diagram of the Intelligent Security Assessment System on *ROBART II* (adapted from Everett, Gilbreath, and Tran, 1990). This concept was later expanded to allow sensor fusion with fixed-installation motion sensors inside the facility patrolled by the robot (Figure 103).

The assessment algorithm was upgraded in 1990 to include consideration of any fixed-installation motion sensors (Figure 103), thereby allowing a mobile robot to operate in a secure area already protected by stand-alone motion sensors. *U.S. Patent No. 5,202,661* for a “Method and System for Fusing Data from Fixed and Mobile Security Sensors” was subsequently awarded to H.R. Everett and Gary Gilbreath on 13 April 1993. A final enhancement involved integrating historical sensor data to assess temporal changes (Smurlo & Everett, 1994), resulting in *U.S. Patent No. 5,493,273* for a “System for Detecting Perturbations in an Environment Using Temporal Sensor Data,” awarded to H.R. Everett and R.P. Smurlo on 20 February 1996.

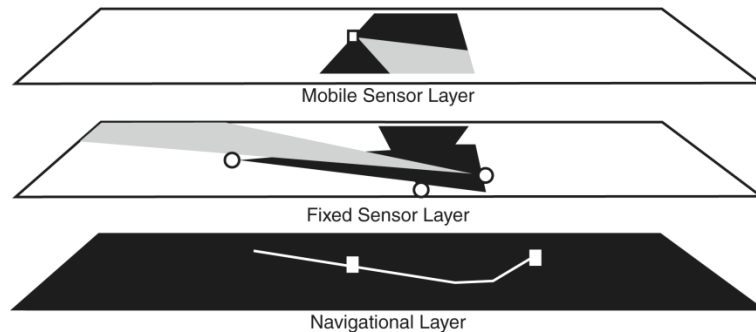

Figure 103. *ROBERT II*'s expanded world model employed two additional bit-map layers to represent the coverage areas of both fixed and mobile intrusion-detection sensors (adapted from Everett, Gilbreath, and Tran, 1990).

Referring now to Figure 104, a detected intruder reported by one of the fixed-installation motion sensors would be relayed to the host computer, which alerted the guard by a *beep* from the console. The Status and Environmental windows shown earlier in Figure 101 were then replaced by the current floorplan map. The security-assessment software determined that the alarmed sensor was not triggered by the moving robot, since its current X-Y position was not within the designated sensor coverage area. The Planner consequently rerouted the robot to a location where its on-board sensors could observe the area of disturbance and locate the intruder. If after a designated period of time with no confirmation from the robot's sensors, the assessment software would downgrade the threat to a nuisance alarm.

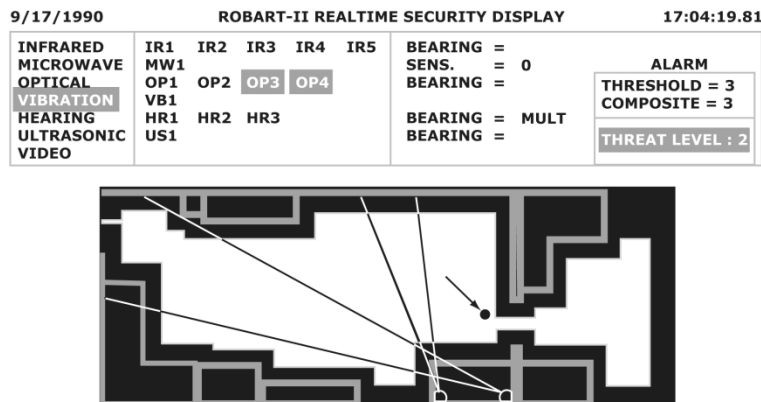

Figure 104. The respective coverage areas for two fixed-installation motion sensors on the bottom wall are overlaid on the X-Y floorplan map. Highlighted here by the diagonal arrow, the calculated position of a confirmed intruder is graphically depicted near the doorway to the adjoining room (adapted from Everett, Gilbreath, and Tran, 1990).

In 1989, a reflexive-teleoperated driving mode (now commonly known as “guarded motion”) was added to *ROBART II* to test mobility behaviors that could reduce the driving burden imposed upon military operators of more simplistic man-portable UGVs (Laird & Everett, 1990). The collision-avoidance sensors, originally intended to provide an envelope of protection during autonomous transit, were called into play during teleoperation to minimize the possibility of operator error (Figure 105). Although *ROBART II* was never intended to be remotely driven by a human operator, reflexive teleoperation was one of the first UGV behaviors for which the system served as a software-developmental surrogate. The commanded speed and direction of the mobility base were servo-controlled in response to local sensor inputs to keep the robot from running into obstructions (Laird & Everett, 1990).

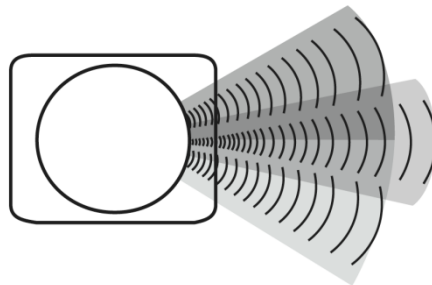

Figure 105. Center, left, and right zones of coverage for the proximity (shaded) and ultrasonic (concentric arcs) sensors. The rate of turn was proportional to the degree of obstacle encroachment into the intended path of travel. *US Patent No. 5,307,271* was awarded H.R. Everett and Gary Gilbreath for this feature on 26 April 1994.

Also on the agenda was the pursuit of localization techniques to better support autonomous navigation in indoor environments (Everett & Gage, 1995b). In the late 1980s to early 1990s, before the ready availability of scanning lasers and simultaneous-localization-and-mapping (SLAM) algorithms, many different approaches were implemented for subsequent evaluation (Everett, Everett, Gilbreath, & Tran, 1990; Borenstein, Everett, Feng, & Wehi, 1997):

- | | |
|--------------------------------------|----------------------------------|
| Ultrasonic transponder triangulation | Real-time wall following |
| Fluxgate compass | Guidepath following |
| Rate gyro | Beacon following |
| Polarized optical heading reference | Beacon referencing |
| Video image processing | Doorway transit referencing |
| Ultrasonic signature matching | Lateral retroreflective sensing |
| Ultrasonic wall referencing | Overhead retroreflective sensing |
| Tactile wall referencing | RF referencing |

The doorway-transit referencing system consisted of two Banner Engineering near-infrared *SM31* emitter/detector pairs mounted on either side of the head as shown in Figure 106. These units were angled slightly so their optical axes crossed at the height of a standard doorway, enabling a diffuse surface at this elevation only to reflect emitted energy back to the corresponding detectors. Careful comparison of the times of overhead detection for each sensor pair enabled calculation of the robot’s heading relative to the known doorway orientation, along with its longitudinal position along the path of travel. The lateral position of the robot relative to the door frame was simultaneously determined by reading the left- and right-most range values measured by the upper Navigational Ultrasonic Array (Everett, Everett, Gilbreath, & Tran, 1990).

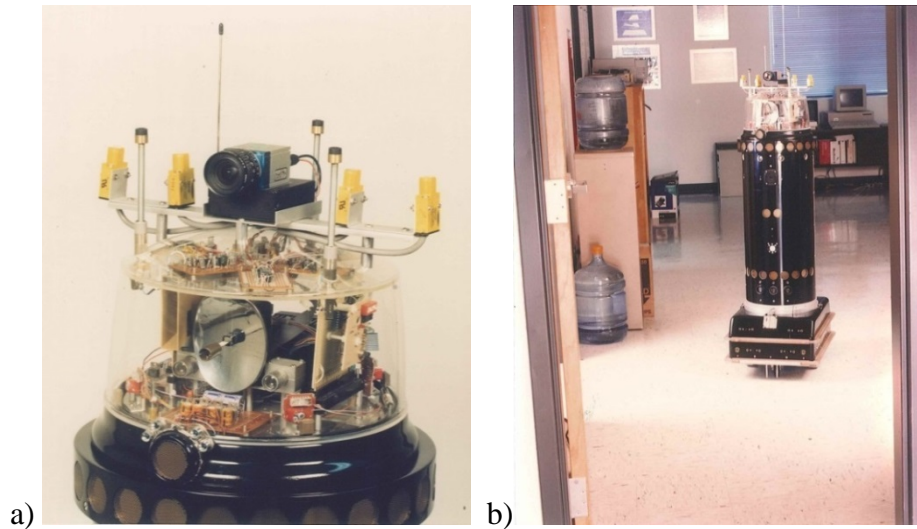

Figure 106. a) The two yellow Banner emitter/detector pairs atop the head were angled slightly so their respective optical axes crossed at the height of a standard doorway. b) *ROBART II* prepares to exit Room 115 of Building 622 Seaside via an open doorway, which would automatically provide an $X-Y-\Theta$ localization update.

Quite a few reports, conference papers, and magazine articles were published on the above work, resulting in engineers from the US Armament Research, Development, and Engineering Center (ARDEC) at Picatinny Arsenal contacting NOSC in 1989 for technical support (Babb, 1990; Newton, 2006). The resulting technology transfer to the Army's *MDARS-Interior* program of record (Figure 107a) is discussed later in the Project Summaries section. With the advent of *ROBART III* in 1992 (Figure 107b), the role of *ROBART II* as a concept-development surrogate came to an end. In spite of having been built at home from hobbyist-grade components, this second-generation security robot proved to be an amazingly reliable piece of equipment, with only four documented cases of hardware failure since officially coming to life in early 1983.

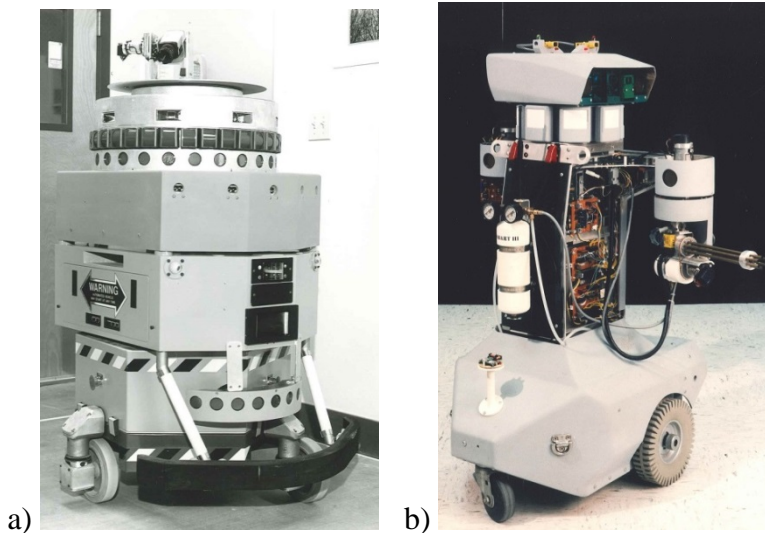

Figure 107. a) The *MDARS-Interior* prototype on patrol in Building F-36, Seaside, circa 1994. b) Early instantiation of *ROBART III* in Building 622, Seaside, circa 1994.

This mean time between failure is rather noteworthy, considering the workout given the system during its 20-year lifetime – records indicate *ROBART II* performed in 53 live demonstrations for visiting students, faculty, scientists, and government officials in 1987 alone. The robot continued to provide demonstrations for visitors, however, and remained on line without a power interruption from 1988 to 2002, when a support contractor disconnected its recharging station over a weekend, allowing the on-board battery to go dead. Dr. John Silva (Code 014) of NOSC estimated the availability of *ROBART II* probably saved the Navy a million dollars in development costs (Davis, 2011) while facilitating significant achievements in path planning, collision avoidance, localization, sensor fusion, and command and control.

Advanced Teleoperator Technology (1983–1985)

Managed by Dave Smith (Code 531) of the Hawaii Lab, the USMC *Advanced Teleoperator Technology* project controlled Chenoweth dune buggies with helmet-mounted-display technology developed under the *Remote-Presence Demonstration System* project in 1981 (Spain, 1987). The orientation of the operator's head would be detected and mimicked at the UGV (Figure 108), so he or she saw the 3D scene from the vehicle driver's seat perspective. The command-and-control station was laid out just like the remote vehicle, with steering wheel, brakes, gas pedal, shift knobs, etc., all in their proper places. The idea was that any Marine who could drive a dune buggy could remotely drive the UGV with minimal training.

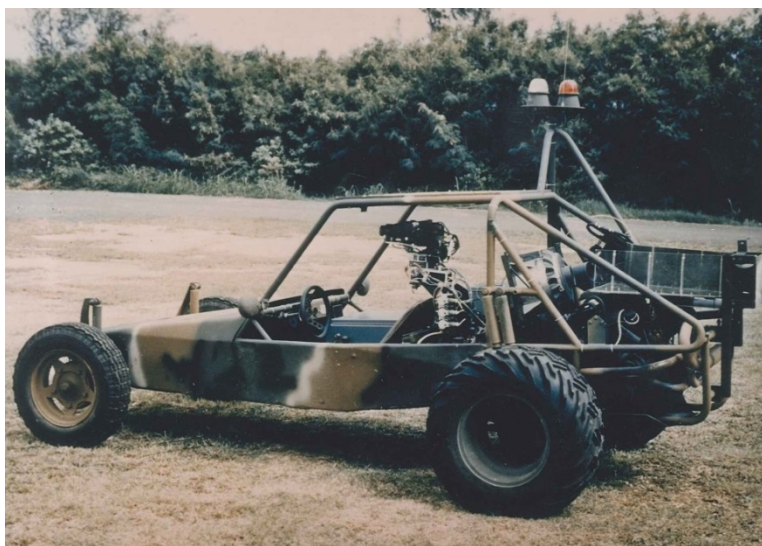

Figure 108. A stereo-camera pan-and-tilt mechanism situated in the driver's seat mimicked the operator's head movements in the control van, as sensed by the Polhemus 3D tracking system. After a few minutes of remote driving, USMC operators began to feel like they were actually sitting in the vehicle itself.

Referring now to Figure 109, the Polhemus 3D tracking system at right calculated the spatial orientation of the small blue transducer shown on top of the operator's helmet relative to a stationary reference directly above (not shown). This 3D-pose information was then used to command the slave pan-and-tilt unit at left to assume an identical pose. This approach allowed the operator to intuitively redirect the robot's gaze in both azimuth and pitch, simply by moving his or her head. System lag introduced by the remote pan-and-tilt actuation scheme and video-signal propagation delays caused decoupling of the human vestibular-ocular reflex, however, causing some operators to experience symptoms of vertigo.

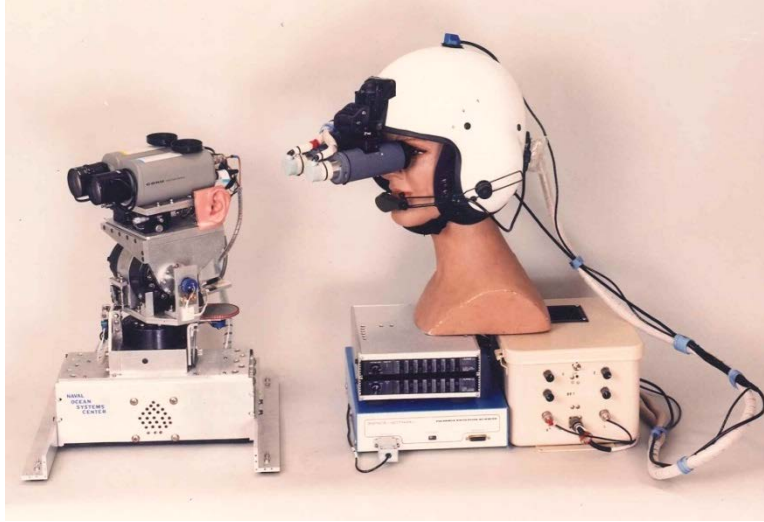

Figure 109. The Polhemus 3D tracking system calculated the spatial orientation of the small blue transducer (upper right) on top of the operator's helmet relative to a stationary reference directly above (not shown). This 3D-pose information was used to command the slave pan-and-tilt unit at left to assume an identical posture.

The prototype weapon payload for the dune buggy consisted of an *M60* machine gun mounted on a custom-built limited-motion pan-and-tilt unit attached to the roll bar as shown in Figure 110 (Umeda, 2015). Live-fire tests were conducted at the Ulupau Crater firing range at Marine Corps Air Station Kaneohe (now Marine Corps Base Hawaii), followed by a more extensive evaluation at Fort Lewis, WA. To assess remote-presence driving effectiveness under degraded visibility conditions, both daytime and nighttime (less than $\frac{1}{4}$ moon) runs were conducted over a predefined course at speeds up to 30 miles per hour. Camera sensitivity was enhanced with *Gen 2+* night-vision systems, resulting in low-resolution monochromatic video, yet drivers were able to successfully negotiate the course using visual depth cues provided by stereo.



Figure 110. Live-fire exercises demonstrated the ability to position the teleoperated dune buggy at a 2- to 4-kilometer standoff distance with remote pan, tilt, and trigger control of the weapon system. To facilitate aiming, an additional video camera was attached to the *M60* gunsight.

Airborne Remotely Operated Device (1984–1988)

The *Airborne Remotely Operated Device (AROD)* was a small ducted-fan vertical-take-off-and-landing (VTOL) air vehicle that could easily translate through the air and provide short-range aerial surveillance. The project was initiated at the NOSC Hawaii Laboratory in 1984 as part of the US Marine Corps Exploratory Development (6.2) Surveillance Program. This effort was continued as part of the *Ground Air Telerobotic Systems (GATERS)* Advanced Technology Demonstration (6.3A) program through late 1980, along with the ground-based *Teloperated Vehicle (TOV)*. Developed by Moller International as a subcontractor to Perceptronics,²⁹ the first-generation *AROD* prototype was electrically powered via a high-voltage tether from the ground station, and was small enough to be carried by a single person.

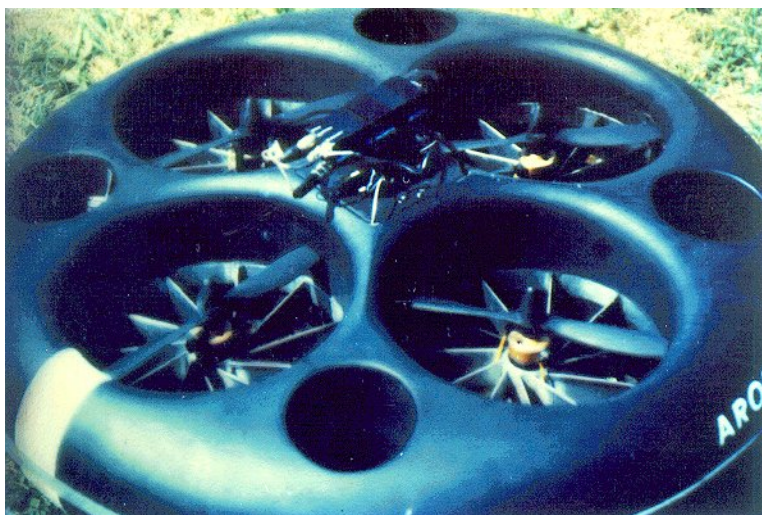

Figure 111. The early NOSC *AROD* prototype was an electrically powered tethered quadrotor built by Moller International, Davis, CA.

While appropriate for concept demonstration, the electrical tether was deemed impractical for military operations. Developed for NOSC by Sandia National Laboratory, the second-generation air vehicles were powered by a 26-horsepower two-stroke gasoline engine driving a single lifting propeller (Figure 112). Servo-driven vanes located at the bottom of the air duct controlled vehicle attitude, allowing hover, multi-directional translation, and rotation about the vertical axis. An automatic flight control system helped maintain vehicle stability. The fiber-optic cable provided bidirectional communications with a small ground control unit, using a radio link as backup. The 5-kilometer spool of optical fiber carried aboard *AROD* could support a 2-kilometer round trip or a 5-kilometer one-way mission.

²⁹ Moller International was previously known as Discojet Corporation, incorporated in 1971.

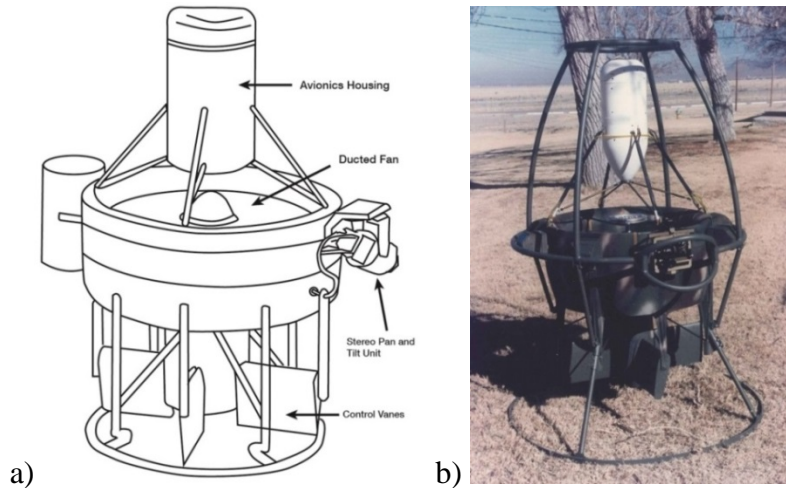

Figure 112. a) Conceptual drawing of the second-generation *AROD* vehicle (redrawn from Bassett, 1987). b) As built for NOSC by Sandia National Laboratories, this ducted-fan *AROD* prototype was gasoline powered (see also Figure 113a).

A three-degree-of-freedom joystick on the operator control unit controlled pitch, roll, and yaw, while a thumbwheel on the stick controlled altitude (Figure 113b). As with the earlier dune-buggy efforts under the *ATT* project, a helmet-mounted display provided stereo vision to the operator, who could aim the on-board camera pair using intuitive head movements. Although the vehicle was successfully tested in free flight, control instabilities prevented it from realizing its full range of performance. *AROD* development was consequently discontinued when funding limitations caused the *Ground Air TeleRobotic System (GATERS)* program (see next section) to shift focus to the *TeleOperated Vehicle* project. This concept was revisited later under the *Air Mobile Ground Security and Surveillance System (AMGSS)*, to be discussed.

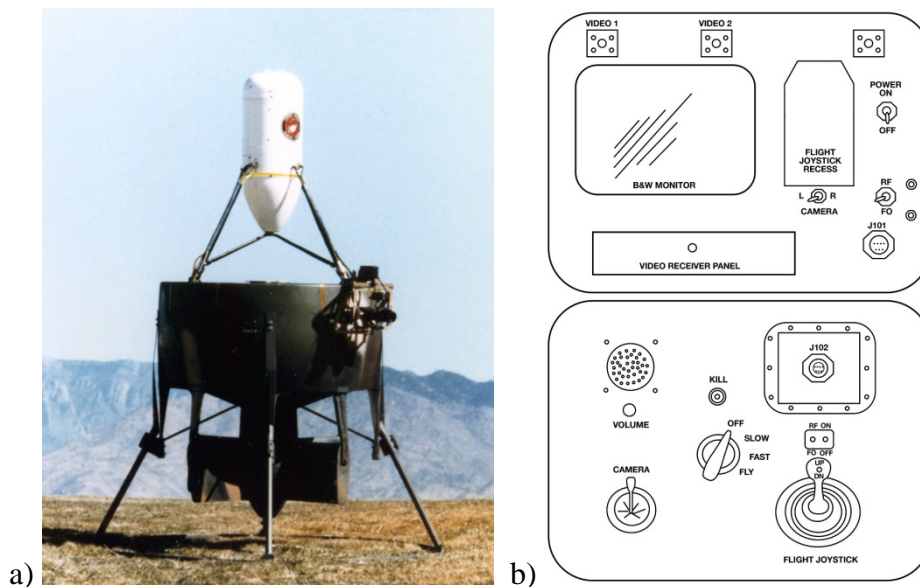

Figure 113. a) Second-generation *AROD* configuration with the NOSC Hawaii Lab's remote-presence stereo-camera pair installed on cowling at right. b) Line drawing of the portable *AROD* operator control station (redrawn from Martinson, 1988).

Ground Air TEleRobotic System (1985–1987)

The *GSR*, *ATT*, and *AROD* achievements led the Office of the Undersecretary of Defense for Tactical Warfare Programs/Land Warfare (OUSD/TWP/LW) to initiate the *Ground/Air TEleRobotic Systems (GATERS)* program in 1985 (Gage, 1995b). Overseen by the Marine Corps Combat Development Command (MCCDC), Quantico, VA, with NOSC serving as the developing laboratory, the objective was to develop teleoperated ground and air systems to support test and evaluation of UXS concepts by prospective military users. The “air” component of *GATERS* was the *Airborne Remotely Operated Device* (Spain, 1988), initiated in 1984 but eventually terminated as previously discussed. The “ground” component was a *HMMWV* equipped with a 0.50-caliber Weapon Payload and a cantilevered Surveillance Payload that could be erected for ISR missions (Figure 114).



Figure 114. The early *Ground/Air TeleRobotic System (GATERS)* prototype developed by Code 531 in Hawaii was a remotely driven *HMMWV* equipped with an elevated reconnaissance, surveillance, and target acquisition (RSTA) payload, with a remotely actuated 0.50-caliber Browning *M2* machine gun for self-defense.

As explained by Hawaii Lab researcher Dr. Hugh Spain (1987), the operationally distinct ground and air vehicles developed under the *GATERS* umbrella shared several common features:

“Both are fiber optically tethered. Both use advanced high-speed telemetry hardware to convey control and feedback signals back and forth across the fiber optic link. But perhaps most importantly, both have developed out of a design approach that emphasizes the importance of providing the human operator with a sense of telepresence, an inside-looking-out experience of the remote system which is intended to impart a sense of being physically present in the vehicle...”

The *TeleOperated Vehicle* project is further discussed in the following section.

TeleOperated Vehicle (1985–1989)

The *TeleOperated Vehicle (TOV)* concept emerged from the *Ground Air TELeRobotic Systems (GATERS)* program initiated in 1985. Built by Code 531 at the NOSC Hawaii Lab as previously discussed,³⁰ the baseline system consisted of a teleoperated *HMMWV* and its associated operator control station, connected by a fiber-optic umbilical that provided secure high-bandwidth non-line-of-sight communications over distances up to 30 kilometers. Extensive mobility testing of the *TOV-1* prototype was conducted in Hawaii to characterize an operator's ability to effectively negotiate challenging driving conditions using the remote-presence stereo-vision system (Figure 115).

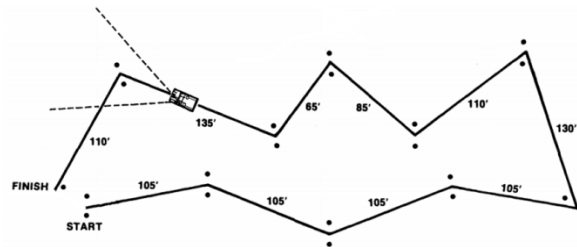

Figure 115. One of six mobility tests used to establish a performance baseline for remote-presence teleoperation, the Gymkhana course featured 11 gates, each 9 feet wide (adapted from Spain, 1987). Gymkhana is a motorsport in which drivers try to achieve the fastest time possible over an obstacle course.

In 1988, the *TOV* effort was relocated to San Diego (Figure 116a), where Code 535 further evaluated and redesigned various components and subsystems in preparation for field testing by the USMC (Figure 116b). The exploratory development and testing previously conducted by Code 531 at the Hawaii Lab was primarily focused on concept development, with insufficient time or funding for system hardening. Under a very tight program schedule, considerable failure analysis, redesign, and fabrication were required in San Diego to ensure reliable performance during extended field testing and subsequent operational demonstrations at Camp Pendleton.

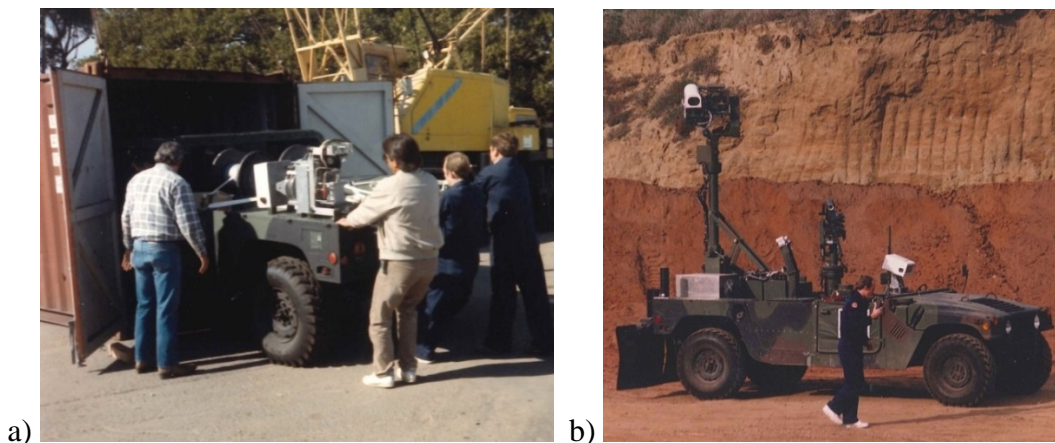

Figure 116. a) Facilities Manager Tom Gaydos, *TOV* team leader Robin Laird, and Commander Bart Everett pull the Hawaii-built *TOV-1* prototype from its shipping crate upon arrival in San Diego, circa 1988. b) Robin Laird doubled as vehicle safety officer during preliminary evaluation and hardening of *TOV-1* along Woodward Road.

³⁰ See earlier Organizational Structure, Advanced Systems Division (Code 53) section.

As with the earlier dune buggies, the *TOV* operator was provided with stereo head-coupled visual displays, binaural audio, and *HMMWV* controls replicated in form, function, and location to minimize required operator training (Metz, Everett, & Myers, 1992). Three operator control stations and one supervisor's station were housed in a military-standard *Lightweight Multipurpose Shelter (LMS)* on the back of another *HMMWV*. Following extensive evaluation at Camp Pendleton (Figure 116b), field trials of *TOV-1* began in May 1988 (Figure 117), to include cross-country transit, long-range RSTA, and remote firing of an *M2* machine gun. Meanwhile, parallel subsystem and vehicle-level testing to identify and correct failure modes continued in San Diego.



Figure 117. *TOV-1* undergoes field testing by Code 535 at the Marine Corps Tactical Systems Support Activity (MCTSSA), Camp Pendleton, CA, in 1988. The *TOV* operator was provided with stereo head-coupled visual displays, binaural audio, and driving controls isomorphic to those found in a *HMMWV* (Aviles et al., 1990).

Two head-mounted microphones served as ears for the robot in the *TOV* driver's seat (Figure 117), providing the operator with stereo hearing to heighten the remote-presence effect. Electric and hydraulic actuators for accelerator, brakes, steering, and gearshift were coupled via the fiber-optic tether to identical components at the operator's station inside the control van (Figure 118a). A low-tension 30-kilometer cable payout system dispensed the control tether as the vehicle moved, avoiding the damage and hampered mobility that would otherwise arise from dragging the cable over the ground (Aviles et al., 1990). The large joystick just right of the steering wheels in Figure 118b controlled the pan-and-tilt actuators for the Weapon and Surveillance Modules.

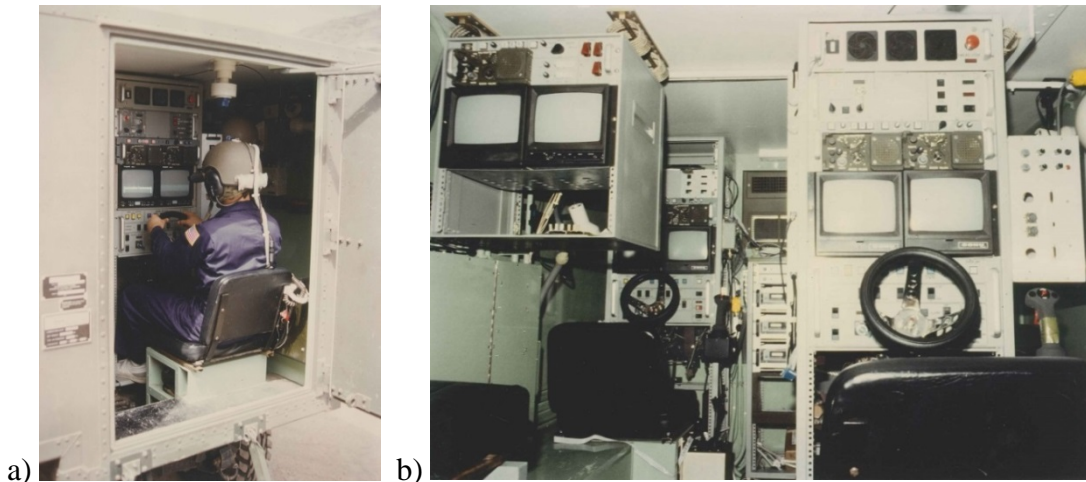

Figure 118. a) Robin Laird sits at “Operator Control Station 1” inside the new control van outfitted by Code 535, which was installed in a *HMMWV*-mounted environmental shelter. b) The shelter housed three operator control stations (foreground right and background) and one supervisor station (foreground left).

The *TOV* project continued under the newly established Unmanned Ground Vehicle Joint Program Office (UGV JPO) *Ground-Launched Hellfire* phase (Metz, Everett, & Myers, 1992), with Commander Everett as chief engineer. *TOV-2*, an improved second-generation version, was designed and built during this period to support an upcoming milestone demonstration in September 1989. To save valuable time, a mockup *HMMWV*-mounted shelter was constructed out of 2x2s skinned on both sides with plywood (Figure 116a) and covered in fiberglass for structural and watertight integrity (Figure 116b). This insulated air-conditioned surrogate shelter allowed simultaneous testing and debugging at our NOSC Seaside facilities, as well as in the field at Camp Pendleton.

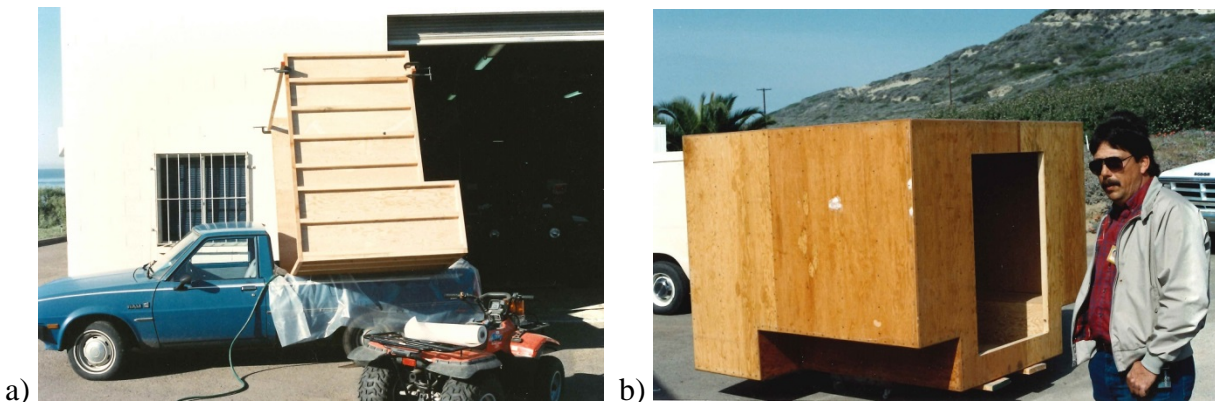

Figure 119. a) A surrogate *HMMWV* shelter was fabricated by Commander Bart Everett to allow simultaneous field testing at our Northern Test Site as well as at Camp Pendleton. b) Seaside Facilities manager Tom Gaydos examines the recently fiberglassed shelter prior to door installation and painting (see also Figure 120b).

Three payload modules for mobility, surveillance, and weapons allowed the *TOV* platforms to be configured for a variety of tactical missions (Aviles et al., 1990; Metz, Everett, & Myers, 1992). The Mobility Module included the necessary video cameras and actuation hardware to enable remote driving from a standoff of several kilometers. Two cameras on the robot in the driver's seat (Figure

120a) fed two miniature video monitors on the operator's helmet (Figure 120b), so that the human driver saw in the van whatever the robot was viewing out in the field (Everett, 2005). As with the *ATT* “Dune Buggy” project, the robot in the remote *HMMWV* was slaved to the operator's helmet back in the control van so as to mimic his or her head movements (Martin & Hutchinson, 1989).

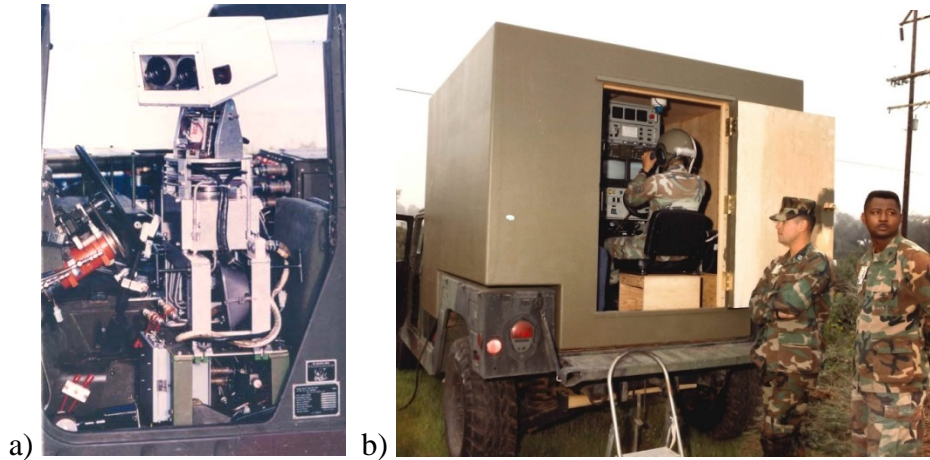

Figure 120. a) A Code 531 remote-presence payload was situated in the driver's seat of *TOV-2*. b) The Polhemus 3D tracking sensor on the ceiling of the surrogate shelter measured the angular orientation of a 3D inductive source attached to the Corporal Rabidoux's helmet. Captain George Murray (center) and Corporal Liburd wait their turn.

The first-generation Surveillance Module, designed and built by the Hawaii Lab for *TOV-1*, was a belt-driven pan-and-tilt unit transporting a 300-pound high-resolution reconnaissance, surveillance, target acquisition (RSTA) package mounted on a cantilevered-lift mechanism that could raise it 12 feet into the air. The sensor suite consisted of a low-light-level zoom camera, an *AN/TAS-4A* infrared imager (FLIR), and an *AN/PAQ-3 Modular Universal Laser Equipment (MULE)* designator (Figure 121). The remote operator would look for a target with the camera or the FLIR, then switch over to the designator to light it up for a laser-guided *Hellfire* missile or *Copperhead* artillery round.



Figure 121. The *TOV* concept allowed RSTA missions to be carried out from a vehicle in defilade, with a 0.50-caliber Weapon Module for self-protection (lower right). Validated targets were illuminated by the *MULE* laser designator atop the Surveillance Module (upper left) for a *Hellfire* missile or *Copperhead* projectile strike.

A key disadvantage of the cantilevered mast was the Surveillance Module could only operate in the fully extended position, as opposed to being raised just above screening cover to minimize chances of detection. Figure 122 shows *TOV-2*, a second-generation UGV developed in San Diego by Code 535. The main improvements in its new Surveillance Module were a far more robust pan-and-tilt unit, and an electrically actuated scissor-lift mast that could be raised to any desired height up to 12 feet (Spackman, 1989). The RSTA-application payload was hardened for field testing, but otherwise identical to that of *TOV-1*, with a *MULE* laser designator plus a FLIR and a conventional zoom camera for long-range surveillance.

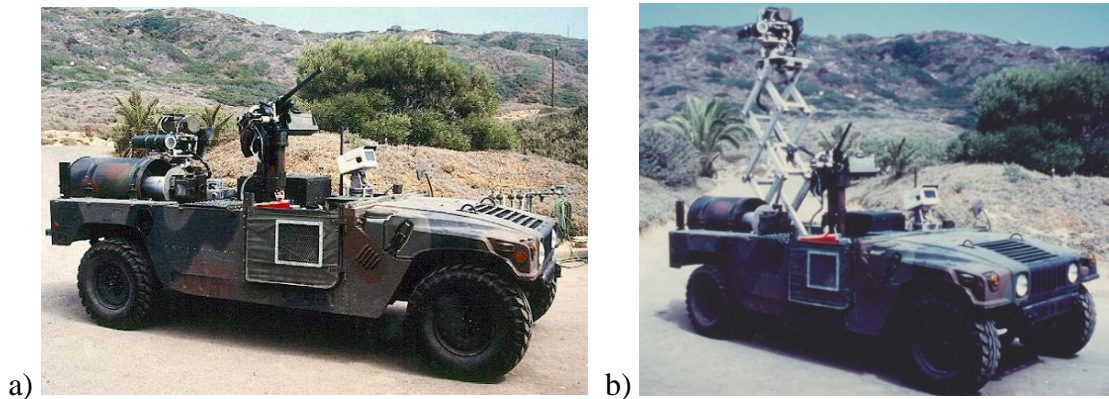

Figure 122. a) Code 535's second-generation *TOV-2* featured a new Surveillance Module (shown stowed) and Weapon Module designed and built by Manuel Solorzano. b) The new Surveillance Module (shown deployed) could be elevated to a maximum height of 12 feet by a scissor-lift mechanism designed by Howard Spackman.

The full range of mast elevation provided by the new scissor lift facilitated maintenance and calibration as shown in Figure 123a, where the *MULE* laser designator has been lowered to a more accessible height for boresighting. This incremental process involved careful alignment of the *MULE* designator with the surveillance camera to ensure reliable target illumination for *Hellfire* missiles or *Copperhead* rounds, after which the mast was raised for testing (Figure 123b). Part of the Surveillance System redesign effort specifically addressed acceleration, moment of inertia, and mounting issues to ensure these components did not shift out of calibration during operation.



Figure 123. a) Robin Laird (right) and Gunnery Sargent Burke (center) boresight the *MULE* laser designator on the Surveillance Module at Camp Pendleton, CA, while Celia Metz (lower left) confers with Major McNamee and Captain Murray. b) Commander Everett supervises subsequent *MULE* testing with the mast fully extended.

The Weapon Module provided the UGVs with a remotely actuated 0.50-caliber Browning *M2* machine gun for self-defense (Figure 124a). In addition to pan-and-tilt motion, electric actuators were installed to charge the weapon, release the safety, and depress the trigger, all hardened second-generation designs intended to eliminate failure modes uncovered on *TOV-1*. A fixed-focus CCD camera (Figure 124b) was mounted just above the gun barrel for safety purposes. The weapon could be manually controlled with the joystick in response to video from this camera, or slaved to the more sophisticated electro-optical sensors of the Surveillance Module.



Figure 124. a) Commander Everett (kneeling) and Rick Smurlo (foreground) prepare to test-fire the 0.50-caliber machine gun of *TOV-1* on the firing line at Camp Pendleton, circa 1989. b) Safety Officer Captain George Murray (seated) oversees testing of the new gun camera and machine-gun actuators prior to installation on *TOV-2*.

In place of the defensive machine gun, *TOV-3* was to have had a Rockwell *Hellfire* missile-launcher version of the Weapon Module. The UGV JPO decided to not to fully outfit this vehicle with a Mobility Module or Surveillance Module in order to save time and funding, so the Rockwell *HMMWV*-based *Ground-Launched Hellfire (GLH)* system was used instead (Figure 125). Another causal factor was that Congressional language in 1987 had restricted the use of funds to acquire and evaluate new weapons mounted on robots (Finkelstein, 2010):

“A congressional staff member believed the TMAP platforms were too small and underpowered to serve as anti-tank weapons;³¹ an urban legend spread that Congress forbid (sic) the development and use of robots as weapons platforms.”

For this reason, the UGV JPO program manager decided to remove the Weapon Module from *TOV-2* just prior to the end-of-project demonstrations in September 1989.

³¹ Two *Teleoperated Mobile All-purpose Platforms (TMAPs)* prototypes, built for the US Army Missile Command by Martin-Marietta and Grumman (Weiss & Simmons, 1989; Metz, Everett, & Myers, 1992), participated in the Camp Pendleton demonstration in September 1989. See also Figure 127.



Figure 125. The Rockwell *HMMWV* with the *Hellfire* missile launcher was set up on an adjoining hilltop for the final demonstration in September 1989. Note *Ground-Launched Hellfire (GLH)* vehicle position in Figure 128.

Celia Metz of Code 535 designed and built the remote interface to accommodate the *Ground-Launched Hellfire* system furnished by Rockwell for evaluation and demonstration. For safety reasons, a dedicated hard-wire control tether was run from the control van to the remote launch site on an adjoining hilltop as shown in Figure 126a. The underlying operational concept was that one teleoperated platform looked and designated while the other did the shooting. Meanwhile, all the humans could be up to 15 kilometers away, which was important in a number of ground-warfare scenarios, particularly chemical or biological.

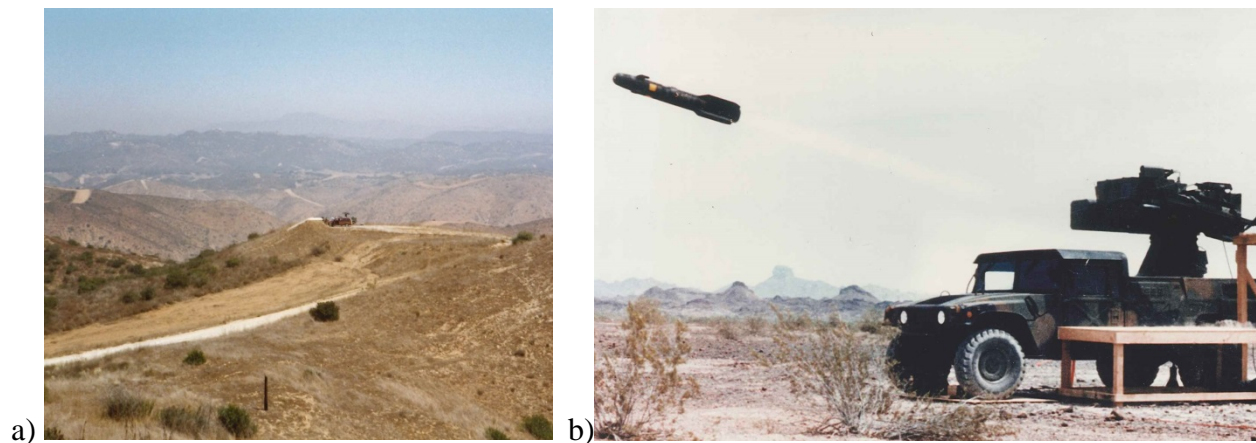

Figure 126. a) The Rockwell-furnished *HMMWV* equipped with its *Ground-Launched Hellfire* payload was situated on a nearby hilltop at Camp Pendleton. b) A *Hellfire* missile comes off the rail in response to a command from the *TOV* operator located in the control van several kilometers away (see also map of Figure 128).

Conducted on a live-fire range at Camp Pendleton, CA, the final *Copperhead* and *Ground-Launched Hellfire* demonstration was a 3-day affair hosted by Lieutenant Colonel Bob Harper of the UGV JPO for multiple groups of VIP attendees. Also featured at this venue were two prototypes of

the *Teleoperated Mobile All-purpose Platforms (TMAPs)* built for the U.S. Army Missile Command by Martin-Marietta and Grumman (Weiss & Simmons, 1989; Metz, Everett, & Myers, 1992). In one of the demo scenarios, the Martin-Marietta *TMAP* also designated a target for a *Hellfire* missile strike (Figure 127), which was remotely launched by the *TOV* operator in the control van.



Figure 127. The Martin-Marietta *TMAP* (foreground) participated in the 1989 “Tele-Robotic Vehicle Demonstrations” (see also Figure 128), along with the Grumman *TMAP* (not shown) and the NOSC *TOV* (background left). The fiber-optic cable-recovery vehicle developed by Code 531 is at background right.

To keep the *TOV* program on schedule, Code 535 had routinely worked 12- to 16-hour days, often 7 days a week, with some taking just 2 days off in 1989 for Thanksgiving and Christmas. To counter the stress and mental fatigue, we built a volleyball court south of Building F-36 with help from Tom Gaydos, the Seaside facilities manager extraordinaire. The resulting exercise and camaraderie recharged both mind and body, the team got its second wind, and it was well on its way to becoming a truly high-performance organization. During the VIP demonstrations that September (Figure 128), the *TOV* system achieved a perfect record of eight direct hits with *Hellfire* missiles and four direct hits with laser-guided *Copperhead* projectiles.

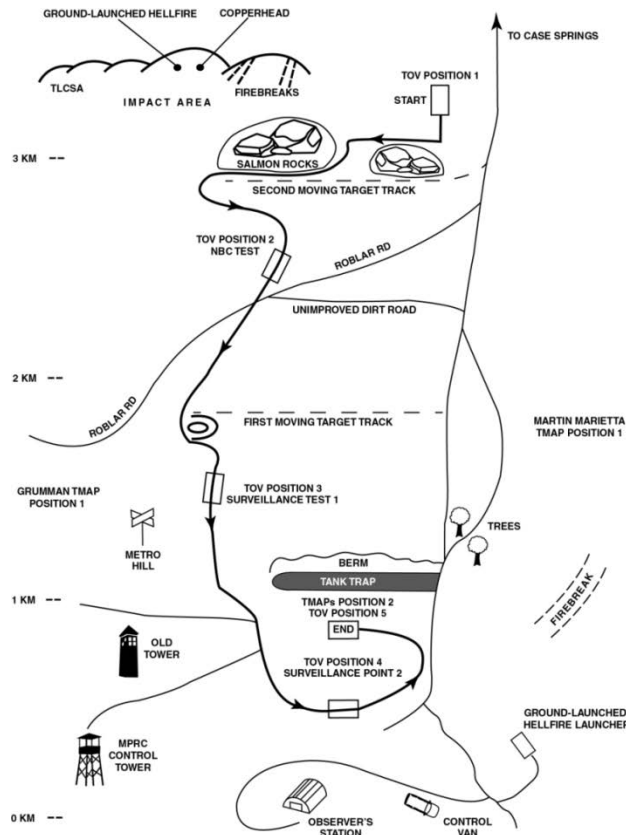

Figure 128. Scheme of Maneuver for the “Tele-Robotic Vehicle Demonstrations” at Camp Pendleton, CA, on 15, 18, and 20 September 1989. Note control van adjacent to the observer’s station (bottom center), the *Hellfire* launch-vehicle position at lower right, and the associated impact area at upper left.

Advanced Tethered Vehicle (1986–1991)

Designed and constructed by Code 53 at the NOSC Hawaii Lab as an improved follow-on to the *Remote Unmanned Work System (RUWS)*, the *Advanced Tethered Vehicle (ATV)* was a purpose-built UUV intended for operation at depths as great as 20,000 feet (Murphy, 1991). Funded by the Naval Sea Systems Command (SEA 05R2), the *ATV* was considerably lighter than *RUWS*, and could be transported by *C-130* aircraft (Lemaire, 1988). The system had a forward speed of 2 knots, could operate in sea state 3, and achieved a mean time between critical failures of 248 hours (Morinaga & Hoffman, 1991).³² As shown in Figure 129, the concept involved a tethered submersible, various surface-handling components, two diesel generators for self-contained power, and an on-deck control van (Hoffman, 1991).

³² The mean time for shipboard repairs was just 6 hours (Morinaga & Hoffman, 1991).

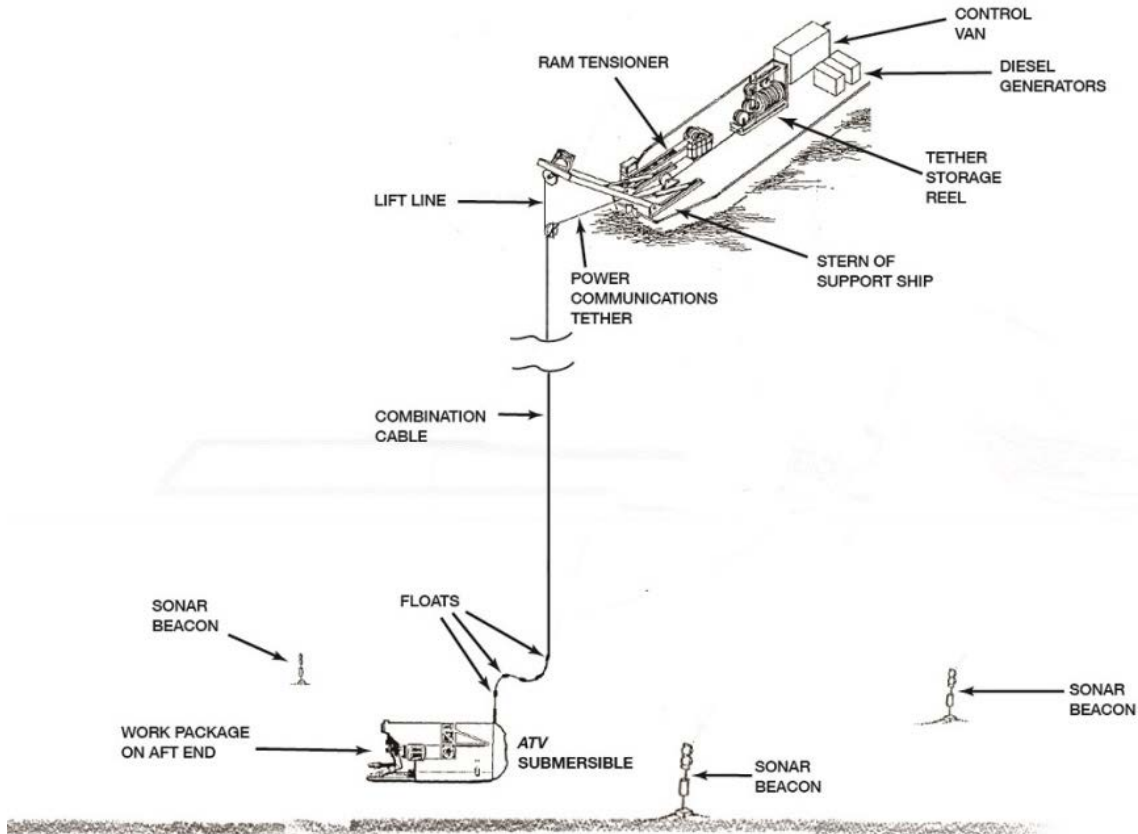

Figure 129. A self-contained system independent of the host ship, the ATV employed a vehicle-lift line in conjunction with a separate power/communications tether (redrawn from Morinaga & Hoffman, 1991). The lift-line ram tensioner eliminated snap loads during vehicle launch and recovery (Yumori, 1988).

While the *RUWS* was employed strictly as a testbed, the *ATV* was intended for fleet use (Lemaire, 1988). The significantly improved design, which largely avoided problems encountered on earlier undersea systems, incorporated many innovative features to improve reliability and simplify both operation and maintenance (Morinaga & Hoffman, 1991):

- A pair of identical manipulators
- Two hydraulic motor/pump units
- Isolated tool hydraulics
- Redundant vehicle electro-optics
- Redundant vehicle-lift capability
- Redundant cable-traction drive motors
- Redundant deck power unit pumps/motors
- Redundant system power supply
- Separate lift line with ram tensioner

The *ATV* was launched and recovered using a steel lift line to avoid stressing the power and communications tether (Figure 130), and could thus be towed by the host ship while floats were attached to the remote end of the combination cable prior to descent. This dual-tether approach also allowed the vehicle to be handled with power off, reduced stresses on the submerged tether termination, and enabled a fully reversible launch/recovery procedure (Hoffman, 1991). A lift-line ram tensioner eliminated snap loads during vehicle launch and recovery, and also permitted the power and communications tether to be supported by the lift line during deep operation to reduce dynamic loading (Yumori, 1988).

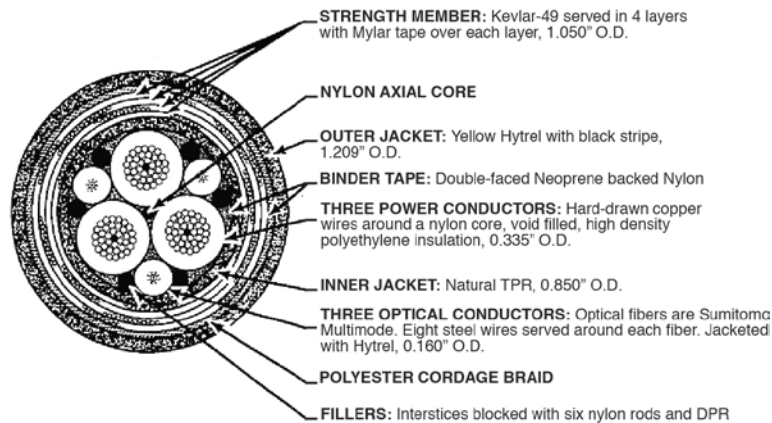

Figure 130. This cross section of the 23,000-foot ATV power and communications tether shows the three fiber-optic cables, three electrical conductors for high-voltage power, and a protective Kevlar strength member (adapted from Morinaga & Hoffman, 1991). See also Figure 132.

The ATV electrical system (Figure 131) was serviced by a pair of three-phase 408-volt diesel generators, each rated for 180 kilowatts. A 30-kilowatt transformer stepped this incoming AC voltage down to 208 and 120 volts to power electronic equipment, lighting, and air conditioning in the control van. Similarly, a 100-kilowatt transformer in the high-voltage console stepped up the 480-volt, three-phase input to 2400 volts to minimize electrical losses along the 23,000-foot umbilical feeding the ATV. On board the submersible, this 2400-volt service was connected to motor switching circuits controlling a pair of 25-horsepower electrohydraulic units, which powered the vehicle thrusters and manipulators. A 5-kilowatt step-down transformer supplied power for on-board electronics, equipment, and lighting (Hoffman, 1991).

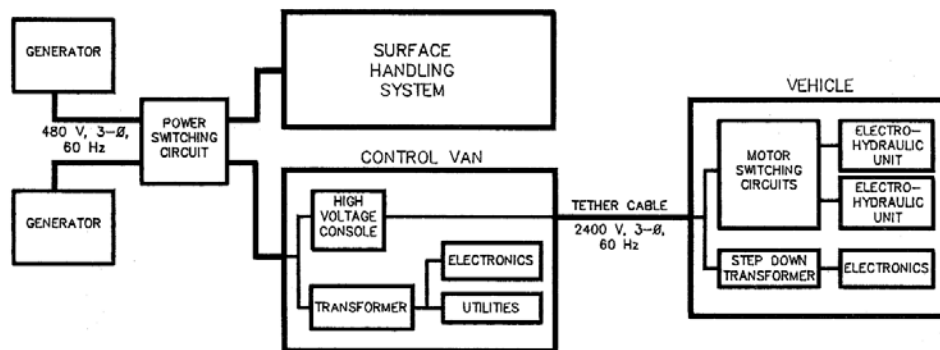

Figure 131. Three-phase 480-volt AC power from the diesel generators was stepped down to 208 and 120 volts for the control van equipment, and stepped up to 2400 volts for transmission down the 23,000-foot umbilical to the ATV, where it was stepped down to power the various vehicle subsystems.

Instead of the conventional all-electric tether used on *RUWS*, the *ATV* umbilical also incorporated three fiber-optic conductors for command-and-control data plus video feedback (Lemaire, 1988). Referring now to the configuration depicted in Figure 132, the telemetry and control interface inside the control van was connected to an optical slip ring at the center of the tether-storage reel (see also Figure 129). Optical switches on the other side of this slip ring determined which of three optical fibers in the tether was used for data transfer (Hoffman, 1991). On board the *ATV*, each of these fibers terminated in redundant electro-optical circuitry that interfaced with the vehicle electronics.

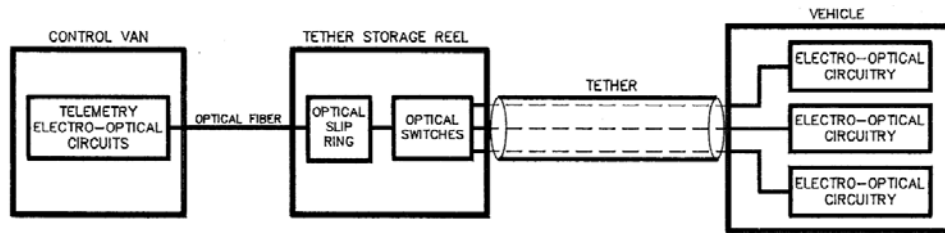

Figure 132. The control van was connected via an optical slip ring to a three-channel switch that could select any one of three redundant optical fibers in the tether to support the necessary full-duplex communication stream.

The two-station control-van layout is shown in Figure 133. The primary vehicle-control interfaces were: 1) joystick propulsion control, and 2) input devices for the dual force-feedback manipulator controllers. Sensor displays included a flat-panel stereo TV, sonar, and navigation (Murphy, 1991). The vehicle-operator station on the right side of the control console integrated selectable real-time video with graphic overlays to minimize the operator's required field of view (Hoffman, 1991). The work-operator station was on the left side of the console, while the tether operator sat at the tether-control station on the far side of the auxiliary console (Hoffman, 1991).

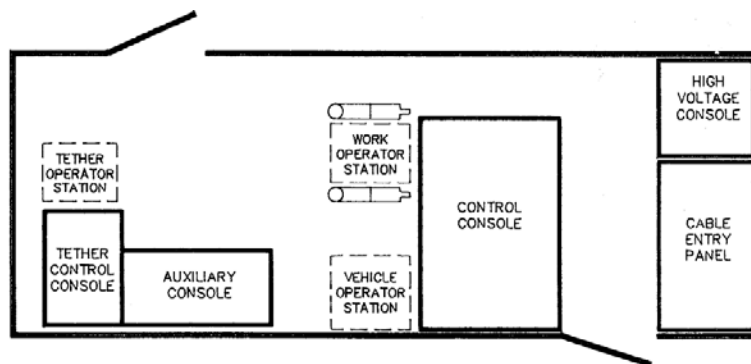

Figure 133. The control van, 8 feet wide by 8 feet high by 20 feet long, featured a centrally located control console with individual control stations for the vehicle operator and work operator (center), as well as a third console for tether control (far left).

As shown in Figure 134a, the ATV frame was constructed from standard aluminum shapes with side and front fairings to reduce drag and provide protection for interior components (Hoffman, 1991). The work package mounted on the aft end of the vehicle featured dual master-slave manipulators, with a stereo-camera pair mounted on a pan-and-tilt unit to create a 3D video representation of the work space. Two additional television cameras were provided, one with a zoom lens (Figure 134b) and one that served as a viewfinder for a 35-millimeter underwater film camera (Murphy, 1991). A fifth television camera and underwater sonar used during transit to the work site were mounted behind the front fairing (Hoffman, 1991).

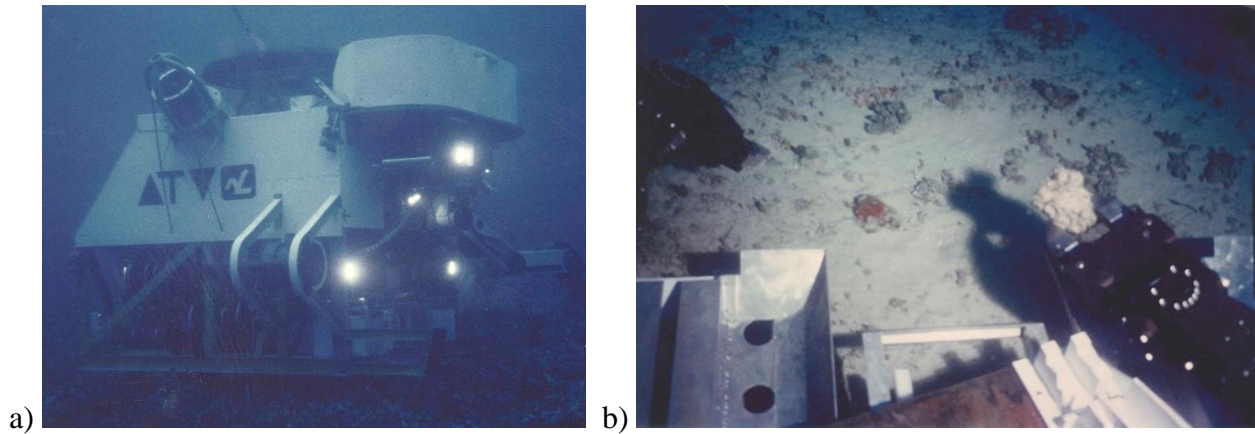

Figure 134. a) The underwater lights for the various work-package television cameras were mounted on the aft end of this preliminary version of the neutrally buoyant ATV submersible. b) Zoomed-in television image of an object grasped by the rightmost master–slave manipulator.

The dual manipulators shown on the aft end of the submersible in Figure 135 featured both position control and force feedback, with a hydraulic tool package that included a spreader, drill motor, wrench, and rotary saw mounted on a support tray below the manipulators. Syntactic foam modules were mounted beneath the top fairing, with hydraulic manifolds and plumbing in the center section, and titanium pressure housings for the electrical and optical components situated on the lower level (Hoffman, 1991). The boom for the power and communications tether (not shown) was pivoted to enable horizontal orientation while being towed on the surface, and vertical once submerged.

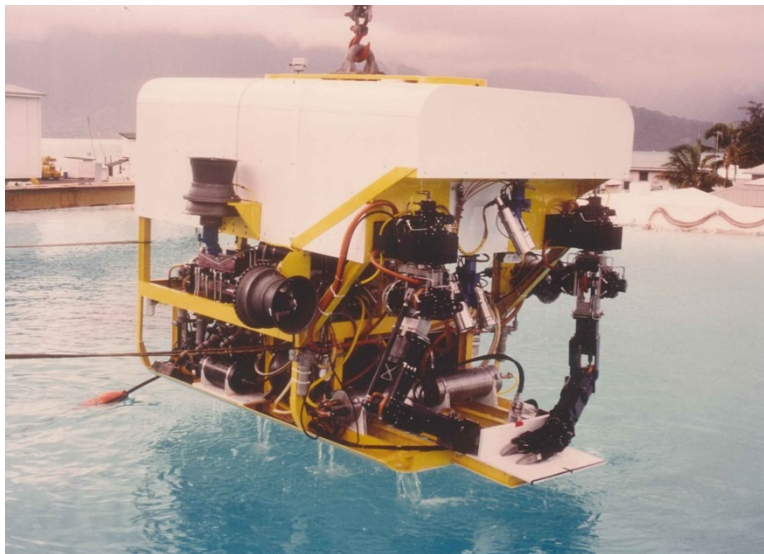

Figure 135. In this interim version of the ATV, the horizontal and vertical thrusters are shown on the port-side, with the dual-manipulator work package mounted on the aft end. Note float on the power and communication tether (in water, lower left) and lifting cable at top center.

Deployment and recovery was accomplished using the small-waterplane-area twin-hull (SWATH) vessel *SSP Kaimalino* shown in Figure 136 (Hightower & Sciple, 1978). Numerous test dives were completed off Hawaii in 1985, reaching depths of 12,000 feet (Lemaire, 1988). In 1990, 21 dives

totaling 248 hours of operation at depths down to 20,600 feet were logged during integrated system test and evaluation, with the *ATV* meeting all its reliability and effectiveness objectives (Hoffman, 1991). Extensive evaluation of the work package showed operators could effectively perform the attachment, manipulation, and tool operation tasks required for deep ocean work. Documentation validation and further system evaluation followed, conducted by the Undersea Robotics Laboratory located Bayside at NOSC.



Figure 136. Built in 1973, the NOSC tandem-strut, small-waterplane-area twin-hull (SWATH) vessel *SSP Kaimalino* provided deployment and recovery services for the *ATV* undersea vehicle during test and evaluation (Lang & Slogget, 1985). The *ATV* was designed for operational deployment from a rescue and salvage ship (ARS).

In February 1993, the *ATV* (Figure 137) was transferred for fleet use to Submarine Development Group One in San Diego (Dziak et al., 1996; Rona et al., 1997).³³ Here it served as the Navy's west-coast unmanned deep-water asset, complementing the *Cable-controlled Underwater Recovery Vehicle III (CURV III)* on the east coast. NOSC continued to provide support, engineering upgrades, and fabrication of new system components. In May 1998, the *ATV* assisted the National Geographic Society in locating/photographing the WWII carrier *USS Yorktown* some 16,650 feet below the surface of the Pacific Ocean (Zumberge, Sasagana, & Spiess, 2006).



Figure 137. The steel lift line is attached to the lifting ring (top center) of this later *ATV* configuration, while the power and communications tether is shown at far left. In addition to its four video cameras, the *ATV* also employed obstacle-avoidance sonar and continuous-transmission frequency-modulated (CTFM) sonar for target acquisition.

³³ Now Submarine Development Squadron 5 in San Diego, CA.

After 8 years of fleet service, the *ATV* was transferred to the Marine Physical Laboratory (MPL) at Scripps Institute of Oceanography, immediately adjacent to NOSC on the Point Loma peninsula in San Diego. The Marine Physical Laboratory and the University of Hawaii were to operate and maintain the UUV for scientific research, while the Navy retained ownership. The system remained idle until 2003, when the Office of Naval Research funded an operational evaluation down to 3600 feet, supported by the Scripps research vessel *R/V Roger Revelle*, with assistance from Ocean engineering personnel (Zumberge, Sasagawa, & Spiess, 2006). Following this successful evolution, however, the *ATV* was demobilized at the Nimitz Marine Facility in Point Loma.

TeleOperator Telepresence System (1988–1992)

Never designed for underwater use, the previously discussed “Green Man” prototype was unable to demonstrate the master–slave proficiency required by the diver-equivalency concept of interest to the Naval Sea Systems Command (NAVSEA). To address this and other identified shortcomings, the second-generation *TeleOperator Telepresence System / Concept Verification Model (TOPS/CVM)* program was initiated in 1988. The end goal was a highly dexterous telerobotic master–slave work system that could mimic the manipulative dexterity of humans (Figure 138), but without their inherent operational limitations (i.e., depth, endurance, temperature, and exposure). Overall systems integration was performed by NOSC Code 53, with key component technologies including human-level dexterity, force-reflective exoskeletal controllers, and stereoscopic vision.

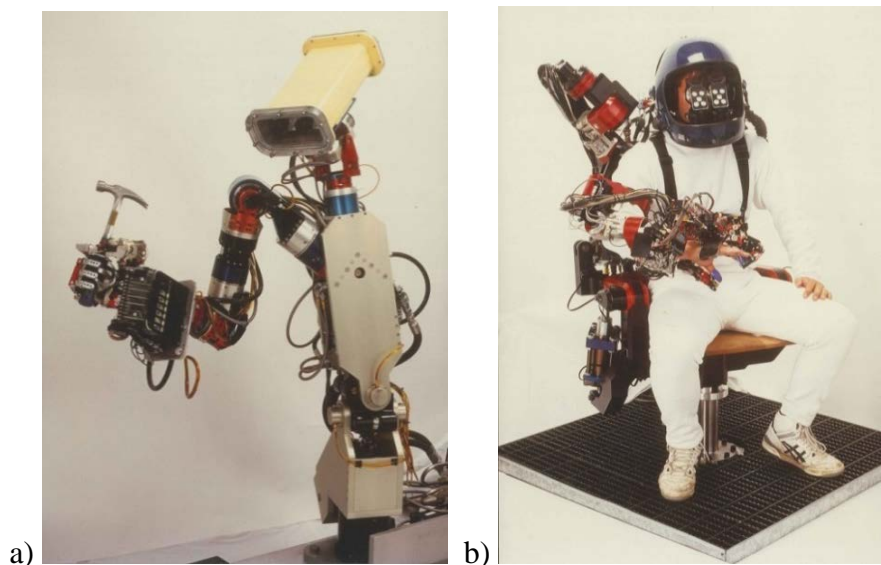

Figure 138. a) The *TOPS* remote slave had a single 9-degree-of-freedom (DOF) hand attached to a 7-DOF arm, which was mounted on a 3-DOF torso. b) The *TOPS* operator used an instrumented exoskeleton to control the slave, based on high-resolution video feedback presented to the operator on a helmet-mounted stereo display.

To extend the work volume of the manipulator, a dexterous 9-DOF force-reflective hand attached to a 7-DOF force-reflective arm was mounted on a 3-DOF torso. On top of the torso was a 3-DOF head equipped with a stereoscopic camera pair that provided a 70-degree field of view with full stereo overlap (see Figure 138a).³⁴ The operator viewed the remote worksite in three dimensions

³⁴ The stereo-vision system employed technologies developed by Wright-Patterson Air Force Base and Technology Innovation Group.

through a high-resolution (1023-line) helmet-mounted display as shown in Figure 138b. The manipulator, arm, torso, and head were developed by Sarcos Research Corporation and the Center for Engineering Design at the University of Utah.

The high-level control and processing system integrated all *TOPS/CVM* subsystems under a Center-developed distributed heterogeneous control paradigm, which featured two separate human-machine interfaces. The Supervisor Interface allowed technical personnel ready access to all sensing and actuation subsystems during development and testing. The Operator Interface allowed the human operator to easily control all major system functions and modes using voice commands with graphic-overlay feedback. The operator remotely commanded the hand/arm combinations through an exoskeletal controller (Figure 139), while the torso and head motions were automatically slaved to those of the operator.

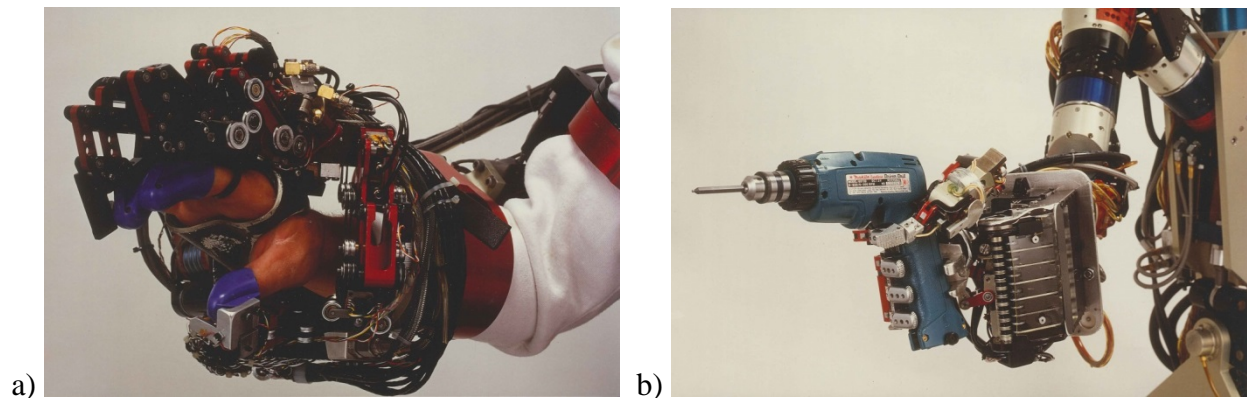

Figure 139. a) This close-up of the right-hand exoskeletal controller shows the degree of complexity involved to achieve near-human equivalence in remote manipulation. b) The sophisticated end effector on the slave could firmly grasp and operate conventional power tools.

Modular Robotic Architecture (1988–1992)

The *Modular Robotic Architecture* was developed as a generic on-board architecture offering developers a standard set of software and hardware tools that could be used to quickly design modular robotic prototypes with minimum start-up overhead (Smurlo & Laird, 1990; Laird, Smurlo, & Timmer, 1991). The concept facilitated customization of a testbed system by providing sensor, actuator, and processing modules that could be configured on demand as required by the particular needs of the application being addressed. In a development environment, the ability to later incorporate newer modules of increasing sophistication facilitated evolutionary growth potential, ensuring maximum effective service life before the system became obsolete.

An example embodiment under this concept, the *ModBot* (modular robot) featured several independent modules of varying sophistication interconnected via a generalized distributed network. The physical design of the interlocking-ring concept originated during earlier discussions between then Lieutenant Commander Bart Everett and MIT co-op student Anita Flynn at the Naval Surface Weapons Center, White Oak, MD, in the summer of 1986. The first instantiation at NOSC consisted of a commercial TRC *LabMate* mobility base (Figure 140), augmented with various sensor, actuator, and processing modules that enabled the robot to obtain and process different information about its surroundings.



Figure 140. Manufactured by Transitions Research Corporation, Bethel, CN, the *LabMate* was used as a mobility base by a number of research groups, and formed the basis of the company's later *HelpMate* robot (Katevas, 2001). The circular aluminum base plate accepts the stacked-ring *ModBot* payloads shown in Figure 141.

As explained by project manager Robin Laird (Babb, 1990):

“The idea of the modular robot is similar to the IBM *PC* with its expansion slots; adding a module to the *ModBot* is like adding a peripheral card to a *PC*. One simply plugs a card into an available slot, installs the supplied software drivers, and incorporates the new capabilities of the card into the system. Adding modules and capabilities to a *ModBot* will be just as simple, making integration of new, smarter, better, faster modules very easy.”

A second-generation adaptation of the irrigation-pipe housing employed on *ROBART II*, the stackable 18-inch rings for the various modules were machined on a lathe to interlock as shown in Figure 141. The 24-transducer Collision-Avoidance Sonar Array was active whenever the robot was in motion, continuously looking for obstacles within a predefined distance and reporting such to the High-Level Processing Module. The Near-Infrared Proximity Sensor Module provided a redundant sensing means for obstacle detection in relatively close proximity to the robot. Used to complement data obtained by the sonar array, this ring contained 11 Banner diffuse-mode optical proximity sensors facing the forward 180 degrees, each adjusted for a maximum detection range of approximately 3 feet.

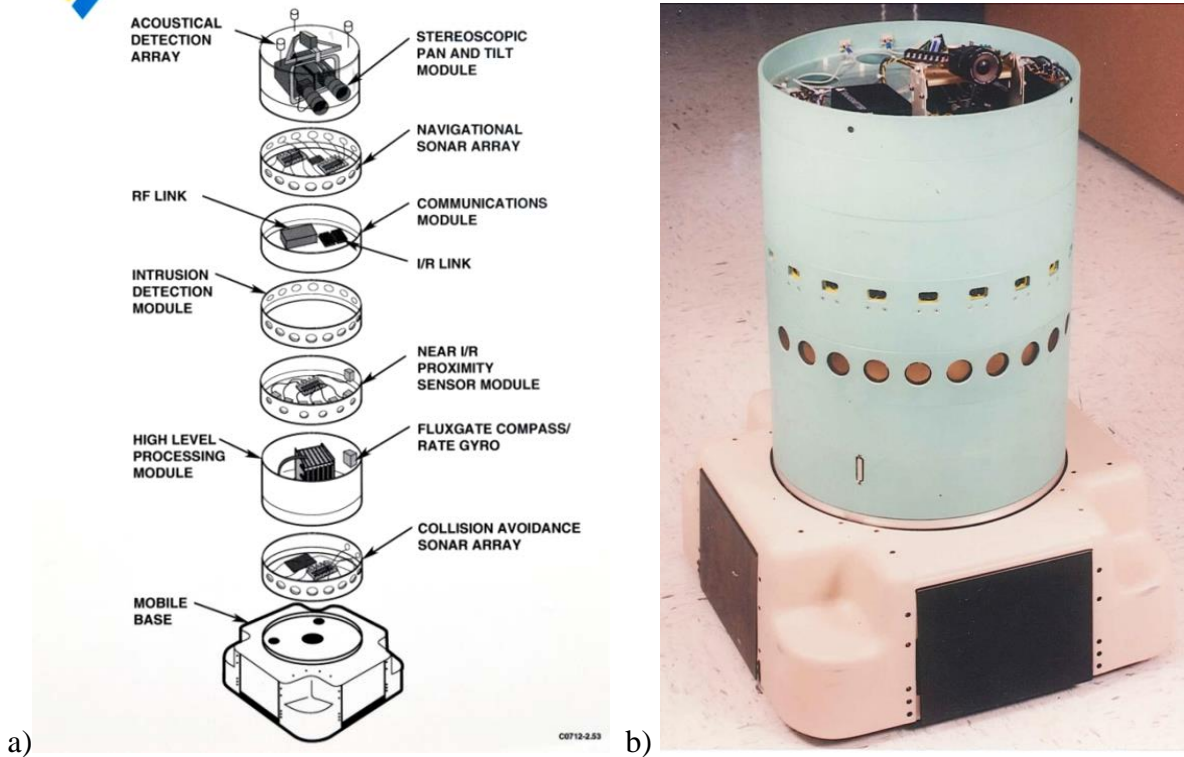

Figure 141. a) Notional block diagram of the NOSC *ModBot* concept. b) The interlocking ring modules employed on the *ModBot* were easily machined from a length of 18-inch-diameter plastic water pipe. This configuration has a custom-designed monocular pan-and-tilt unit built by technician Steve Timmer.

The High-Level Processing Module (Figure 141a), which housed a WinSystems *AT286* computer mounted in a card cage (Figure 142), used an internal map representation and information from other modules to plan and execute paths to desired waypoints. This on-board module also received external commands from the remote Control Station Module, which communicated with the *ModBot* via the on-board Communications Module. An *RS-232* umbilical cable was used during the early stages of development, later replaced by an *OCI LAWN* spread-spectrum RF link. Some exploratory work was also performed using a full-duplex, near-infrared datalink made by STI. The modular nature of the robot and its on-board architecture allowed these Communications Module tradeoffs to be quickly assessed without any reconfiguration necessary for other system modules.

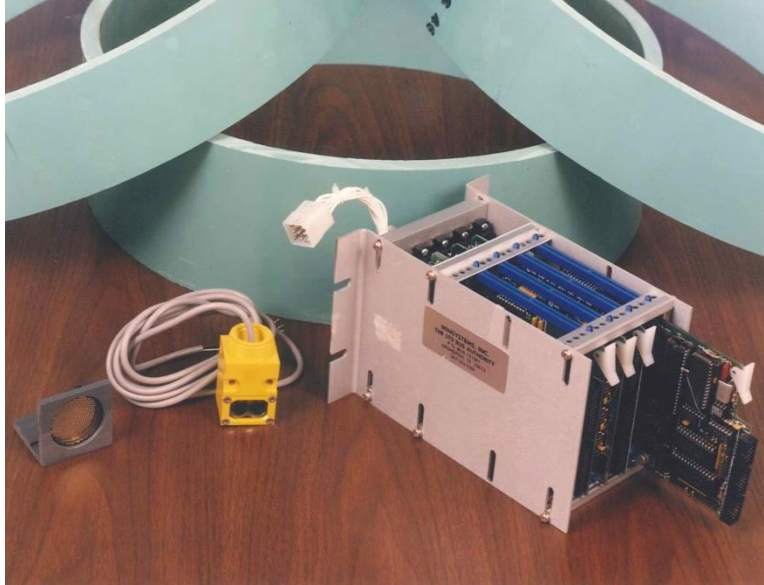

Figure 142. The High-Level Processing Module of the *ModBot* housed one or in some cases two WinSystems AT286 computers mounted in a card cage as shown at lower right (see also Figure 143). The 18-inch-ID ring sections in the background are shown prior to being machined to interlock when stacked as shown in Figure 141.

This flexibility and extensibility of the *ModBot* architecture made it a valuable testbed for expeditious pursuit of new ideas and applications involving robot mobility. One of the first was an upgraded version of the robotic-security concepts developed on *ROBART II*. The Intrusion Detection Module was used to detect human movement in the vicinity of the robot and report the perceived range and bearing to a remotely located Control Station Module. This on-board subsystem consisted of ultrasonic, passive-infrared, and microwave motion detectors covering the full 360-degree field of regard. A video motion detector in this module also received information from the video sensors on the Stereoscopic Pan-and-Tilt Module to determine if an intruder was present. Audio and composite-video signals were transmitted back to the operator via two separate analog RF links.

This modular approach greatly facilitated technology transfer to both Cybermotion and ARDEC for the newly established *MDARS-Interior* program (Babb, 1990), which employed the Cybermotion *K2A Navmaster* mobility base (Cadwallander et al., 1993). In early 1990, NOSC engineers began mentoring their Army counterparts in all aspects of indoor robotic security, transferring existing 6502-based software developed on *ROBART II* for conversion to 68HC11-based code (Everett, Everett, Gilbreath, & Tran, 1990). This converted code was to run on a custom single-board computer built by Dr. Stanley H. Smith of S.H. Smith Associates, Montville, NJ, which was specifically designed for compatibility with the 64-pin Eurocard connector used on the *K2A Navmaster* expansion bus (Smith, 1992; Cadwallander & Smith, 1993).



Figure 143. The *ModBot* concept facilitated transfer of component technologies developed on *ROBART II* to ARDEC engineers for use on the *MDARS Interior* program (Babb, 1990). Shown left to right: Tim Papayianis of ARDEC, along with Steve Timmer, Rick Smurlo, and Robin Laird of NOSC.

ARDEC elected to adopt the modular payload design of the *ModBot* with slightly larger 24-inch sections of plastic pipe (Figure 144b). This approach allowed each of the payload modules to be assigned to individual ARDEC engineers for replication: 1) video, 2) acoustic, 3) microwave, 4) passive infrared, 5) sonar, and 6) security assessment. As a consequence, many of the challenges associated with power distribution, on-board communications, and interference were inherently eliminated. An obvious concern, however, was that many of the 13 localization strategies developed on *ROBART II* for use in office environments (e.g., wall following, doorway transit) would be relatively ineffective in unstructured warehouse environments.



Figure 144. Shown here atop a Cybermotion *K-2A Navmaster* mobility base, the ARDEC *MDARS-Interior* payload was a 24-inch-diameter *ModBot* configuration with six stacked modules for video, acoustic, microwave, passive infrared, sonar, and security assessment.

One of the alternative localization technologies consequently investigated by NOSC was a guidepath-following system used by automated guided vehicles (AGVs) in similar industrial scenarios. Rather than rely entirely upon guidepath following, the envisioned *MDARS* approach was to use a hybrid navigation scheme featuring sections of guidepath “freeways” installed only in those areas deemed difficult for off-path navigation (Holland, Everett, & Gilbreath, 1990). The initial prototype tested for *MDARS* was inspired by the use of a Litton guidepath sensor employed on a Bell and Howell mail-delivery cart (Figure 145a), which had been operational for years in Building A33 Topside at NOSC (Everett, 1995a).

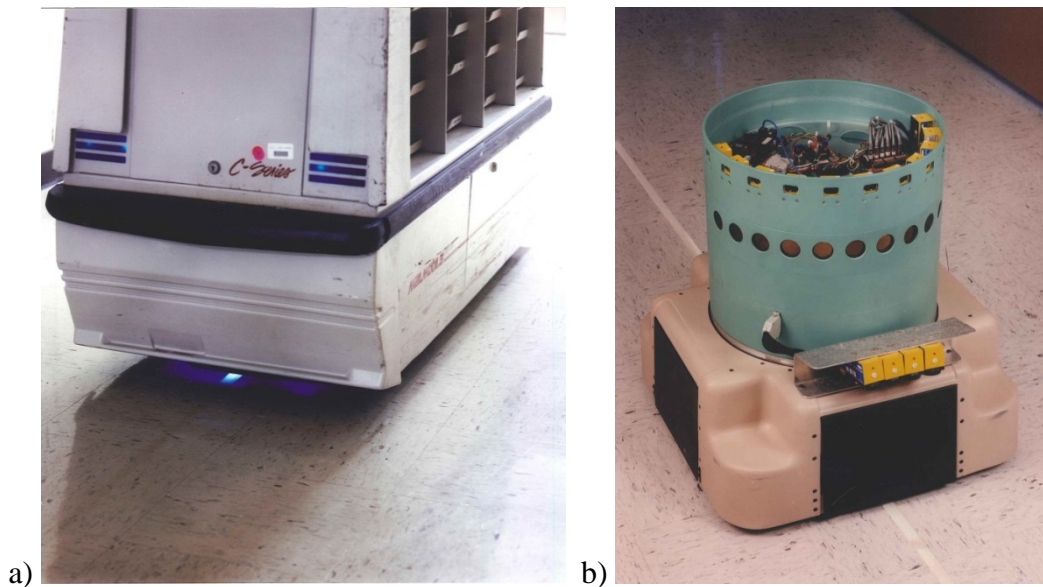

Figure 145. a) Shown here on a mail-delivery cart in Building A33, the Litton guidepath sensor followed a transparent chemical stripe that visibly glowed due to secondary emissions when irradiated by ultraviolet light (Everett, 1995a). b) An alternative NOSC design employed an array of four Banner retroreflective sensors.

A less expensive alternative to the Litton stripe-follower was investigated for this purpose, in which a retroreflective tape was tracked by an array of four Banner near-infrared sensors (Figure 145b). This approach was rejected due to anticipated guidepath degradation in industrial settings. The Litton guidepath was far superior in this regard to the retroreflective tape, in that it was nearly invisible to the eye (except under ultraviolet light) and held up well over time. Accordingly, the *Reconfigurable Video Line Digitizer* software developed for *ROBART II* was modified to digitize the output of a CCD camera viewing the illuminated chemical guidepath on the floor surface immediately ahead of the *ModBot* (Figure 146).

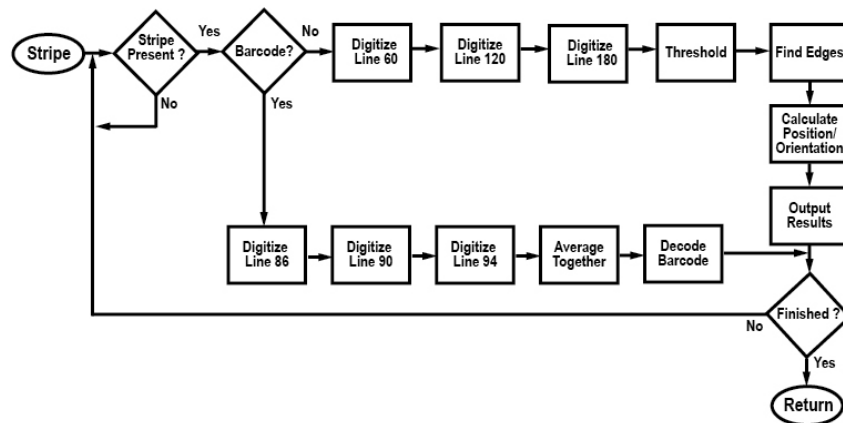

Figure 146. Originally developed for video motion detection as a security sensor, this block diagram shows the *Reconfigurable Video Line Digitizer* used to digitize video lines 60, 120, and 180 for tracking secondary emissions from the UV-stimulated chemical guidepath. Barcoded position markers adjacent to the stripe could also be read.

For testing purposes, masking tape performed admirably as a temporary guidepath when irradiated by an ultraviolet source. Developed by Theresa Tran, the new software determined the real-time lateral offset and orientation of the guidepath from three digitized video lines as shown in Figure 147. The white rectangle in the image outlines the camera field of view, while the three horizontal lines of the skewed figure-8 pattern reflect guidepath detection by the three video scan lines. The inherent modularity of the *ModBot* architecture greatly facilitated this component test and evaluation in parallel with ongoing *MDARS* development, without tying up any *MDARS*-specific resources. The guidepath “freeway” concept, however, was found to be unnecessary in later warehouse installations of *MDARS-Interior*.

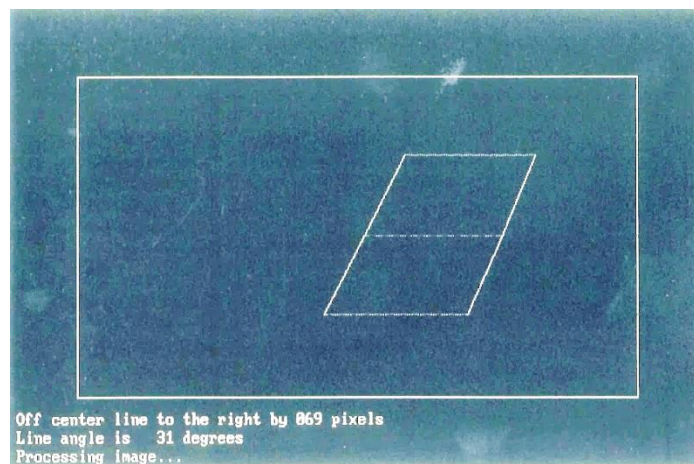

Figure 147. Screenshot showing horizontal plot of digitized video lines 60, 120, and 180 from the *Reconfigurable Video Line Digitizer* developed under the *ROBART II* Independent Exploratory Development effort. The robot’s lateral offset and orientation with respect to the guidepath stripe as calculated by the software appear at lower left.

Another example of the *ModBot* facilitating rapid response to customer needs involved hazardous-waste inspection for the U.S. Department of Energy (DoE) at the Savannah River Site in Aiken, SC. The Center was asked to evaluate potential navigational referencing sensors for this new-start robotic

effort to automatically inspect stored 55-gallon drums of nuclear waste. The drums were typically packed four to a standard shipping pallet, which in turn was stacked three high and arranged in rows. Potential mobility platforms under consideration were the Cybermotion *K3A Navmaster* and the TRC *LabMate*. This application was further complicated because the access aisles among the rows of stacked drums were very narrow, leaving very little room for navigational errors.

One of the tasks addressed by NOSC was detecting the center of each drum so the robot would be appropriately positioned to capture a high-resolution position-stamped video image, which was later post-processed to identify any barrel deterioration or leakage. The *ModBot* was quickly configured with the new optical proximity-sensor ring shown in Figure 148a to complement its sonar-array ring. This approach allowed simultaneous testing of both sensor options on a common drum target, which made cross correlation of the results far more relevant and timely. Cybermotion, meanwhile, was brought under contract by DoE to build a prototype visual-inspection payload that could image all three drums in the stack (Figure 148b).

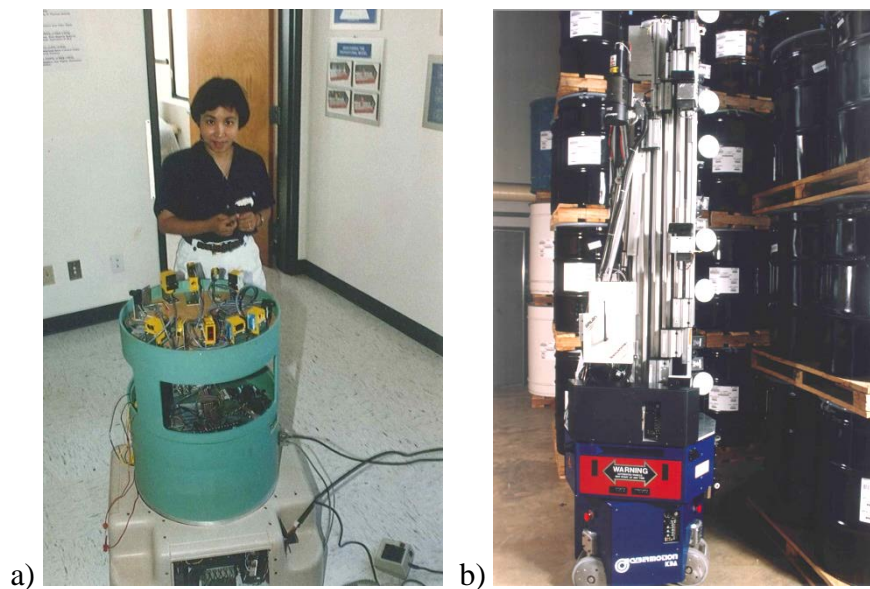

Figure 148. a) Shown here with electrical engineer Theresa Tran, the *ModBot* was quickly reconfigured with a variety of near-infrared proximity sensors for individual evaluation in a drum-detection role. b) The vision-based drum-inspection payload atop this *K3A Navmaster* base was developed for DoE by Cybermotion, Inc.

Another configuration of the *ModBot* served as a ready testbed for the *Sensor-Motor Transformation* research project, which applied biological neural modeling to autonomous robotic control (Figure 149a). As all processing and software development took place on the *ModBot* itself, an additional High-Level Processing Module was added to house an *80486*-based computer hosting two Intel *i860* co-processors and a 120-megabyte hard drive. Sensor input consisted of data from the video camera (Figure 149b) and wheel encoders, all other *ModBot* sensor modules having been removed or disconnected. This effort is discussed in further detail in the Project Summaries section of this volume entitled *Sensor-Motor Transformation*.

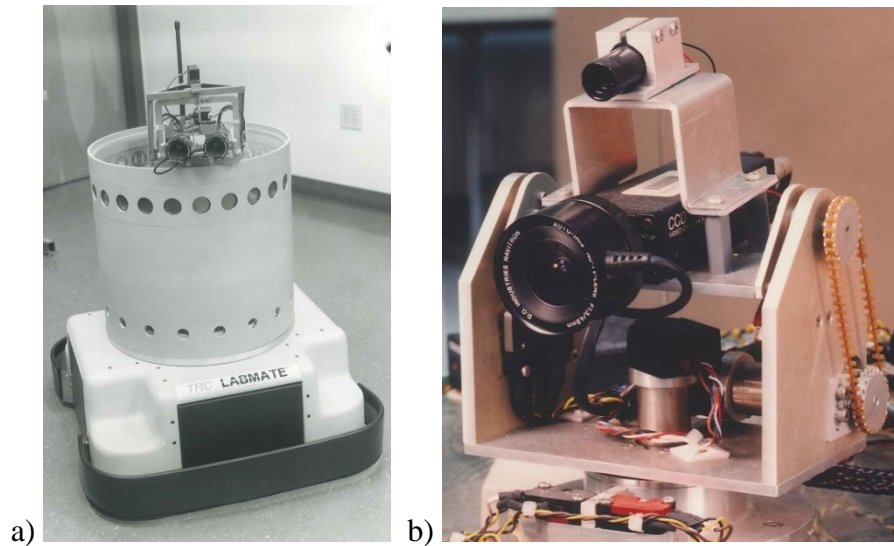

Figure 149. a) The *ModBot* configured with a Sonar, Proximity, and two High-Level Processing Modules to support the *Robotic Sensor-Motor Transformation* payload, circa 1990. b) Close up of the video camera and laser pointer on a video pan-and-tilt unit built by technician Steve Timmer.

The stacked-ring concept employed on the *ModBot*, while well suited for research, development, and evaluation, was clearly not practical for production systems, as there are far better ways to optimize size and weight. In retrospect, however, there were a number of benefits realized, many of which were not always fully appreciated at the time, that significantly influenced the path forward. The most obvious of these was the ability to rapidly respond to an emergent customer or sponsor need, as illustrated by the DoE nuclear-inspection query. Equally apparent was the facilitation of technology transfer, as reflected in the transition of robotic-security hardware and software from *ROBART II* to the U.S. Army via the *ModBot*.

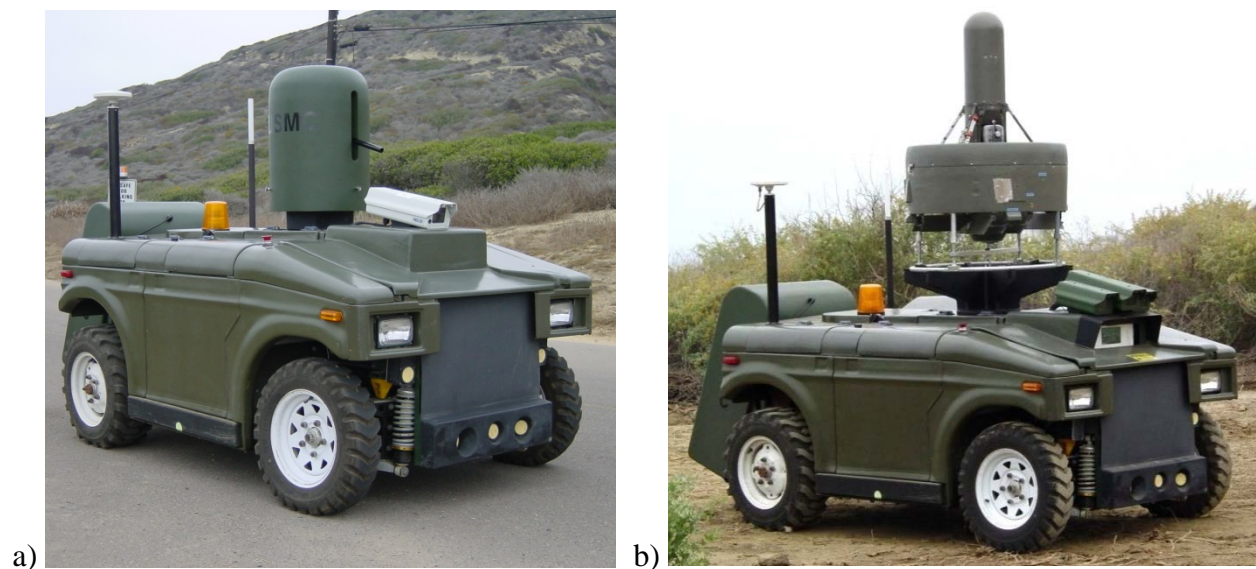

Figure 150. a) The pepper-ball gunpod payload was attached to a standard mounting plate atop the *MDARS-Exterior* security robot, which is further discussed in a later section. b) The vertical-takeoff launch-and-recover payload quickly attached to the same standard mount. See also Figure 151.

The long-term impact was subtle but far more significant. As the term *ModBot* implies, the underlying concept further encouraged a modular approach that influenced everything the Advanced Technology Development Branch undertook. The numerous payloads developed for *MDARS-Exterior* shared a standardized mounting scheme, as evidenced by the various gun pods (Figure 150a) and UAV launch/recover payloads (Figure 150b) on top, and the marsupial UGV carrier (Figure 151a) and UAV refueling payload on the back (Figure 151b). This modular mindset was key to the subsequent development of the *Multi-robot Operator Control Unit (MOCU)* command-and-control and *Autonomous Capabilities Suite (ACS)* on-board architectures, both of which facilitated our later *Interoperability Profile* support for the RS JPO.

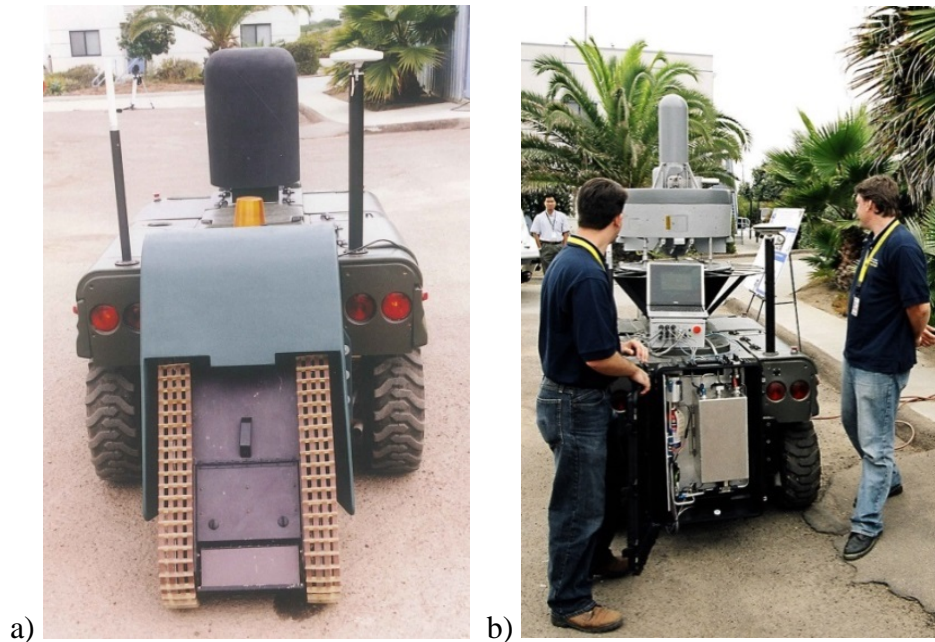

Figure 151. a) The tracked *Man-Portable Robotic System* robot is shown descending from the marsupial carrier on the back of the *MDARS-Exterior* (BAA-version) robot. b) The *Autonomous UAV Mission System (AUMS)* refueling payload attaches to the same standardized mounts on the top and rear of the *MDARS* platform.

CHRONOLOGICAL PROJECT SUMMARIES (1990–1999)

In 1992, the Naval Ocean Systems Center (NOSC) was renamed the Naval Command Control and Ocean Surveillance Center (NCCOSC), which later became the Space and Naval Warfare Systems Center San Diego (SSC San Diego) in 1997. In 1993, the Advanced Technology Development Branch (Code 535) was reorganized as the Adaptive Systems Branch (Code 531), with the organizational code later changed from Code 531 to Code D371 in 1996 (Appendix E).

Surrogate Teleoperated Vehicle (1990–1992)

Concerned by a proliferation of apparently uncoordinated DoD development efforts, Congress mandated as part of the FY 1990 Defense Appropriations Bill that all UGV projects be consolidated under the policy and program direction of the Office of the Secretary of Defense (Metz, Everett, & Myers, 1992). To facilitate this goal, the Unmanned Ground Vehicle Joint Program Office (UGV

JPO)³⁵ had been stood up in Huntsville, AL, in 1988 as the central focal point for the development and fielding of U.S. Army and Marine Corps UGV systems (Anderson, 2014). A key element of UGV JPO strategy involved near-term fielding of multiple testbed vehicles that could allow users to generate and refine operational concepts.

To help achieve this goal, the *TOV* portion of *GATERS* transitioned to the *Surrogate Teleoperated Vehicle (STV)* program in 1990. Overseen by the UGV JPO, the *STV* (Figure 152) was developed under contract to the Naval Command Control and Ocean Surveillance Center (NCCOSC, formerly NOSC) by Robotic Systems Technology (RST), Westminster, MD.³⁶ Fourteen delivered vehicles enabled large numbers of military personnel to gain valuable hands-on UGV experience that could positively influence subsequent acquisition strategies (Metz, Everett, & Myers, 1992).³⁷ The *STV* was designed small enough to be helicopter- and *HMMWV*-transportable, yet large enough to accommodate a human driver, with sufficient speed to keep up with a tactical convoy (35 mph).

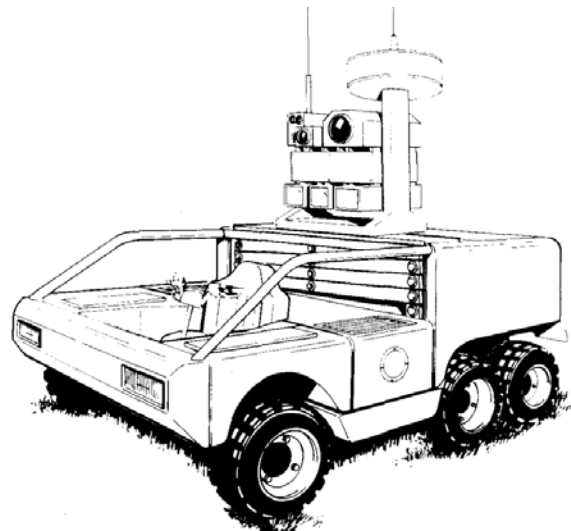

Figure 152. Conceptual line drawing of the *Surrogate Teleoperated Vehicle* designed and built by RST under contract to the NCCOSC, San Diego, CA, and overseen by Tom Bamberg (adapted from Myers, 1991).

The system architecture included four principal subsystems: 1) the remote platform, 2) the Mobility/RSTA module, 3) the communications system, and 4) the operator control unit (Myers, 1991). Based upon a commercial Polaris Industries *Big Boss* six-wheel-drive all-terrain vehicle measuring 117.5 inches long and 50.5 inches wide, the remote platform could traverse standing water up to 2 feet deep (Myers, 1992). A three-cylinder, 25-horsepower diesel engine built by Fuji Heavy Industries powered the Ackerman-steered vehicle at speeds up to 35 mph (Gage, 1995b). Coupled to the gearbox input shaft via an electric clutch (Figure 153), an auxiliary 3-horsepower electric golf-cart motor enabled extremely quiet movement during surveillance operations at reduced speed (4 mph).

³⁵ Later redesignated as the Robotic Systems Joint Program Office (RS JPO).

³⁶ Now General Dynamics Robotic Systems (GDRS).

³⁷ Additional vehicles with a different paint scheme were delivered to the French (Del Giorno, 2015).

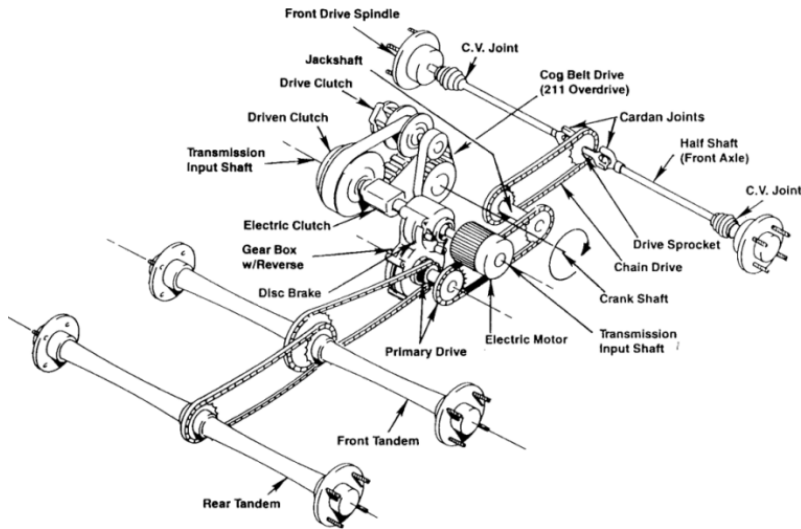

Figure 153. Normally powered by a 25-horsepower diesel engine, the STV could switch to 3-horsepower electric drive for covert operation at reduced speeds up to 4 mph (adapted from Myers, 1991).

In similar fashion to its *TOV* predecessor, the mobility/RSTA module consisted of a number of reconnaissance, surveillance, and target-acquisition sensors mounted on a pan-and-tilt mechanism situated atop an extendable scissor-lift mast. In its stowed configuration, the mast was only 24 inches high (Figure 154a), but could raise the sensor pod to a full height of 15 feet above ground level (Figure 154b). Adjustable pneumatic springs in the rear of the vehicle provided for stiffening the suspension when the surveillance mast was elevated, thus reducing sway and jitter during RSTA operations (Metz, Everett, & Myers, 1992).



a)



b)

Figure 154. a) The STV turns west off Woodward onto Robart Road during onsite testing in San Diego, CA. b) Shown here with its RSTA Module partially elevated, the STV was controlled by a motorcycle-type steering device (inset lower right) on the operator control unit (image courtesy General Dynamics Robotic Systems).

Referring now to Figure 155, the mobility/RSTA sensors included:

- A stereo pair of 460-line daytime driving cameras
- An image-intensified camera pair for nighttime driving
- A day targeting camera equipped with a 14-to-1 zoom lens
- An image-intensified night targeting camera with a 10-to-1 zoom lens
- An *IRIS-T* FLIR (forward-looking infrared camera)
- Either an *LTM-86* laser ranger/designator or an *ESL-100* eye-safe laser ranger

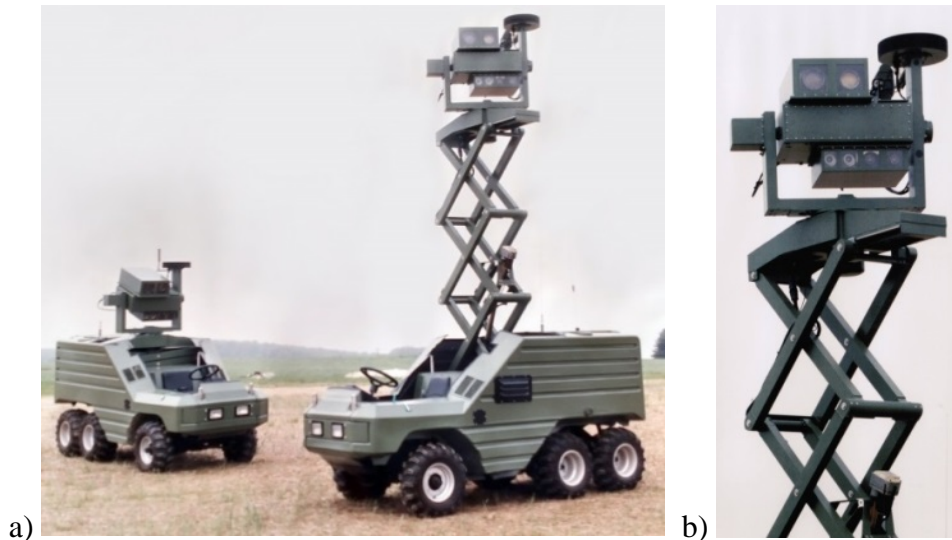

Figure 155. a) A pair of olive drab STVs prior to delivery to the French. b) The zoom color and image-intensified cameras share an enclosure on top left of the tilt axis assembly, with an *ESL-100* laser rangefinder and acoustical array at top right. The color and image-intensified stereo pairs are mounted on the bottom (Del Giorno, 2015).³⁸

The operator control unit employed a motorcycle-type steering device for speed and directional control, with a two-degree-of-freedom joystick for camera pan and tilt. The STV communications system allowed the vehicle to be controlled from the man-portable operator control unit using either a deployed fiber-optic tether or a back-up RF link (RST, 1993). The 10-kilometer inside-wound fiber-optic spool was packaged in a 3.5-cubic-foot cargo box behind the engine compartment, with a hinged lid for easy access (Myers, 1992). A low-tension payout scheme fed the 2.5-millimeter cable out the back as the vehicle moved forward.

The RF back-up communications system consisted of the following components (RST, 1993):

- A 9600-baud full-duplex (dual-frequency) Repco *SLQ-96 Radio Modem* for command and status data
- A Repco *Utility Data System (UDS)* FM transmitter for audio to the vehicle
- A Dell-Star Technologies *900-Series* video transmitter for video and audio from the vehicle to the operator control unit

The maximum effective operating range on level-terrain in RF mode was approximately 2 kilometers.

³⁸ Normally mounted beneath the tilt axis next to the stereo pairs, the *IRIS-T* FLIR was not delivered to the French (Del Giorno, 2015).

In February and March 1992, the first *STV* produced was fielded with a group of soldiers and Marines in a Concept of Employment Exercise (COEE) at Fort Hunter-Liggett, CA (Figure 156). While the unmanned vehicle demonstrated it could maneuver well in heavily wooded areas and on muddy slopes, it could not traverse deep ditches, and the RSTA package used the full payload capacity of the platform, which limited future flexibility. On the positive side, it was confirmed that “remote presence” visual displays such as stereo-vision and pitch-and-roll icons facilitated driving at higher speeds and on steeper side slopes by providing an enhanced sense of spatial and geographic awareness (Metz, 1992).



Figure 156. The remotely operated *STV* fords a shallow stream at Fort Hunter-Liggett, CA, during the Concept of Employment Exercise (COEE) in 1992.

Mobile Detection Assessment Response System-Interior (1990–2003)

DoD awareness generated by the 1989 USMC *GATERS* demonstration, as well as continuing publicity garnered by *ROBART II*, resulted in the U.S. Army asking NOSC to support the *Mobile Detection Assessment Response System (MDARS)* robotic-security program of record. The *ROBART* series of laboratory surrogates (Figure 157) directly addressed the desired *MDARS* functionality reflected in the program name as follows (Davis, 2011):

- **Detection:** *ROBART I* could detect a potential intruder (Everett, 1982).
- **Assessment:** *ROBART II* could both detect and assess, thereby reducing the number of nuisance alarms (Smurlo & Everett, 1992).
- **Response:** *ROBART III* (see next section) demonstrated the feasibility of automated response, using a surrogate Gatling-type nonlethal weapon (Everett & Gage, 1996).

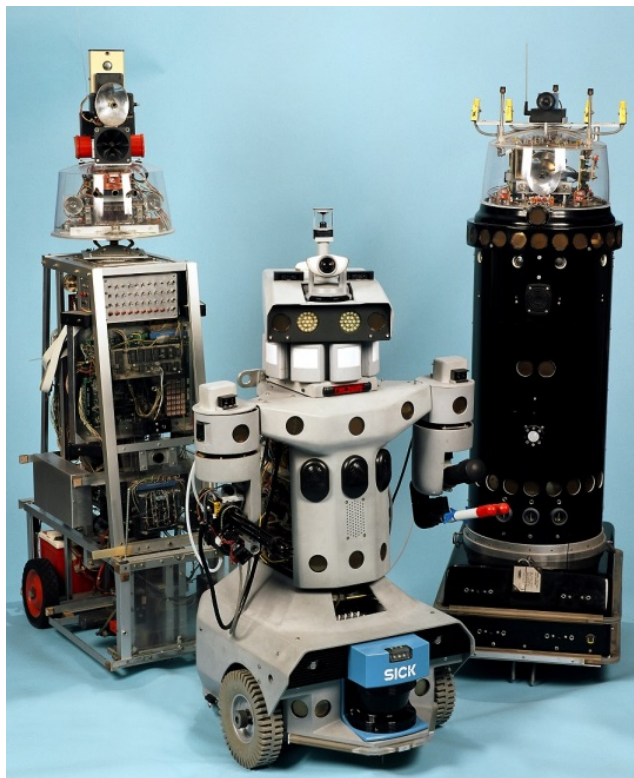

Figure 157. The *ROBART* series of laboratory surrogates developed the component technologies required for the *Mobile Detection Assessment Response System (MDARS)* project, the start of continuous funding from the U.S. Army program office for some 15 physical-security and force-protection projects through 2014.³⁹

Funded by the Physical Security Equipment Management Office (PSEMO), Fort Belvoir, VA,⁴⁰ the *MDARS-Interior* program goal was to provide multiple robotic platforms performing random patrols within DoD warehouses to detect intruders and monitor inventory status (Pransky, 1997). Two commercially available robotic platforms were purchased and evaluated for this application: 1) the *K2A Navmaster* mobility base developed by Cybermotion, Inc. of Roanoke, VA, for material-handling applications (Figure 158a); and 2) the *Sentry* robot developed by Denning Mobile Robots of Woburn, MA, for indoor security applications (Figure 158b).

³⁹ The Army Product Manager, Force Protection Systems (PdM-FPS) at Fort Belvoir (formerly PM-PSE, formerly PSEMO) has funded SSC Pacific for over 25 years on a variety of physical-security/force-protection applications.

⁴⁰ PSEMO was headed at the time by Lieutenant Colonel Larry Petcu, with Jerry Edwards serving as lead project officer for *MDARS*.

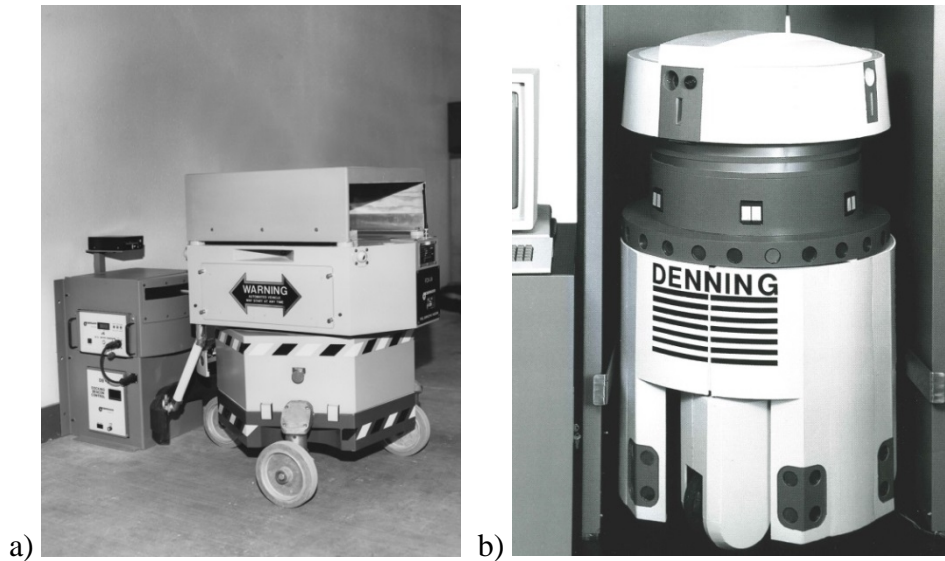

Figure 158. a) The *K2A Navmaster* robot was used as a mobility platform by a number of robotic researchers. The plywood turret extension (upper right) was built by Commander Everett to temporarily house potential payload components for evaluation. b) The 4-foot-tall Denning *Sentry* robot is shown here inside its recharging booth.

While the Denning *Sentry* was equipped with many of the same motion-detection sensors as *ROBART II* (Figure 159), no fusion of their output states was performed to increase the probability of detection and reduce nuisance alarms. The company's developmental focus had been indoor navigation using a vision-based homing scheme that tracked near-infrared LED beacons hidden in the walls of an office environment (Kadonoff, 1994), which would have been problematic in warehouse scenarios. The Cybermotion *Navmaster* had no security sensors (the company later added a video camera), but its navigation scheme was far more robust and required no substantial modifications to the operating environment, so it consequently became the mobility base of choice (Babb, 1990).



Figure 159. Shown here next to *ROBART II* in the museum area of Building 624 Seaside, the Denning *Sentry* employed microwave and passive-infrared motion sensors similar to those used on *ROBART II*. Denning began development of the *Sentry* in August 1983 (Everett, 1998).

NOSC provided *MDARS* with second-generation collision-avoidance, path-planning, and security-assessment payloads adapted from systems previously developed on *ROBART II*. To expedite progress and reduce risk, two different prototypes were pursued, one in Building F-36 Seaside at NOSC in San Diego as shown in Figure 160a. The other version (Figure 160b), employing various component technologies furnished by NOSC, was assembled by Army engineers at Building 30 of the Armament Research Development and Engineering Center (ARDEC), Picatinny Arsenal, NJ (Cadwallander, 1993). Both these prototypes employed the Cybermotion *K2A Navmaster* material-handling mobility base as shown below.

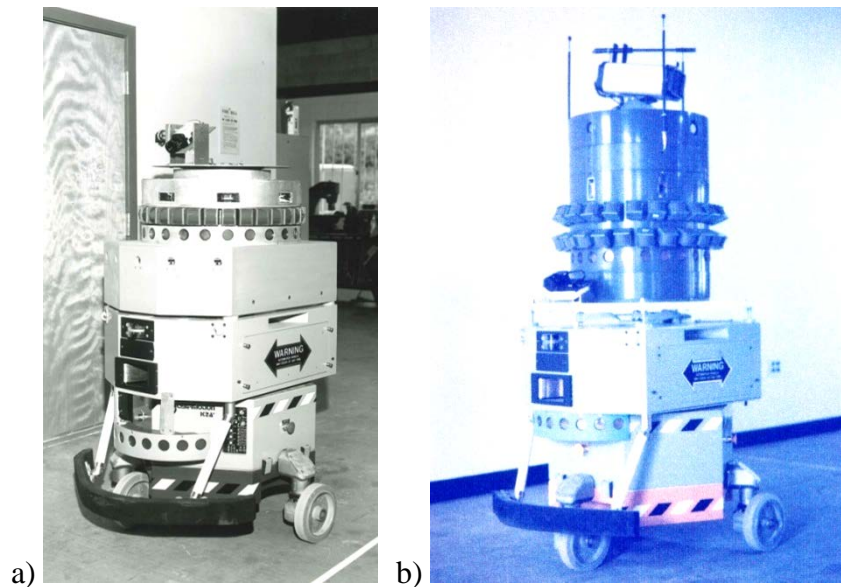

Figure 160. a) The NOSC *MDARS-Interior* prototype featured video, microwave, passive-infrared, and sonar motion sensors, circa 1992. b) The NOSC collision-avoidance sonar upgrade is mounted below the turret of the ARDEC prototype, with ARDEC's stacked-ring security-assessment payload above.

To facilitate technology transfer from NOSC, the physical configuration of the ARDEC security-assessment payload was based on interlocking plastic-ring sections per the previously discussed *ModBot* concept (see again Figure 160b). Note the three microphones of the passive acoustic-detection array, originally developed on *ROBART II*, mounted on the video pan-and-tilt unit at the top of the robot. NOSC also provided duplicates of *ROBART II*'s camera pan-and-tilt software, video motion-detection system, and the collision-avoidance proximity and sonar arrays (see block diagram of Figure 161). ARDEC's tasking involved converting the 6502 assembly-language software to 68HC11 code and repackaging the hardware (Bradley et al., 1993).

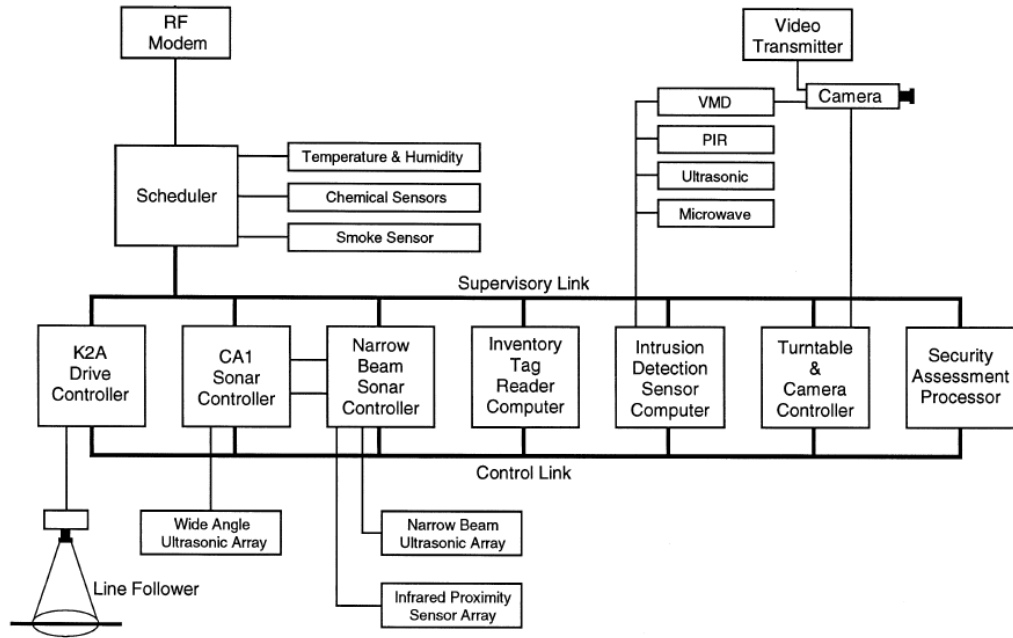

Figure 161. Block diagram of the *MDARS-Interior* functionality integrated into the *K2A Navmaster* architecture via Cybermotion's existing Supervisory Link and Control Link buses.

To help introduce the *MDARS-Interior* program to prospective users, a fiberglass mockup of the NOSC prototype vehicle was constructed for PSEMO by Commander Everett (Figure 162). All external accessories (decals, latches, sonar transducers, the docking port, and the beacon-sensor assembly) were purchased from Cybermotion. In anticipation of rough handling during transport, tandem wheel assemblies were employed to minimize structural problems, but otherwise the mockup was a high-fidelity replica of the real thing. (Cybermotion later incorporated tandem-wheel drive on their *K3A* platform upgrade, as shown in Figure 175.)

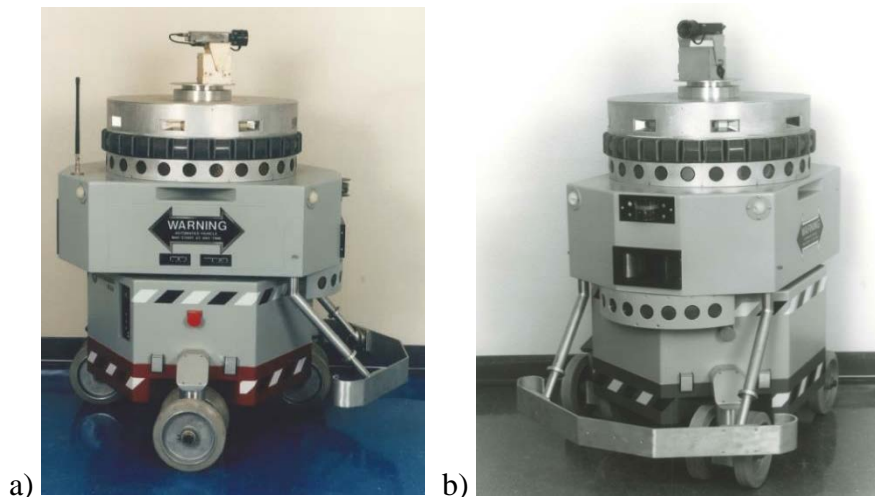

Figure 162. Outfitted with a surplus prototype of the security-assessment payload, this lightweight fiberglass mockup of the Cybermotion *K2A Navmaster* vehicle was constructed on weekends by Commander Everett in his garage workshop to provide PSEMO with a static display for use at conferences and trade shows.

In support of the *MDARS* inventory-assessment mission, a radio-frequency identification (RFID) payload consisting of the Amtech *AI1200 Reader* and *AR2200 RF Module* was tested by ARDEC on a second *K2A Navmaster robot* (Eng, Lu, & Bradley, 1992). The initial Technical Feasibility Test (TFT-I) of the *MDARS-Interior* system, conducted in Building 30 at Picatinny Arsenal, primarily focused on mobility and security assessment, and did not address RFID product assessment. The *ROBART II* video-line motion detector proved to be the most reliable security sensor tested during this evaluation. An alternate product-inventory payload was evaluated by NOSC in San Diego, using Savi RFID tags (Figure 163) and interrogators (Figure 164a) interfaced to the NOSC-developed *Product Assessment Database* (Smurlo et al., 1995).

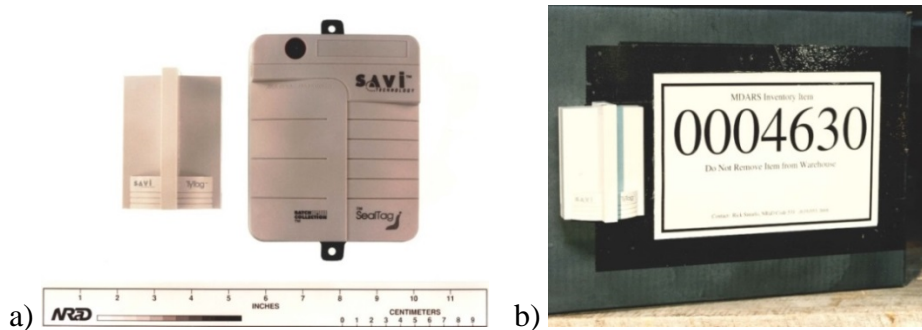

Figure 163. a). The Savi *TyTag* (left) and its *SealTag* derivative (right), which was essentially a *TyTag* modified to accept and report external binary inputs in addition to its tag ID. b) A number of Savi *TyTags* were attached to empty cardboard boxes distributed throughout a warehouse environment for RFID evaluation.

In March 1992, NOSC entered into a cooperative research and development agreement (CRADA) with Cybermotion to add a security payload to the company's *K2A Navmaster robot*. The CRADA objective was to transfer *ROBART II's* intelligent security-detection-and-assessment software to Cybermotion so the company could reproduce it in a more cost-effective configuration that could become a commercial product (Babb, 1990). Rather than employ a multi-sensor staring array as used by the government to demonstrate *MDARS* feasibility, the very elegant Cybermotion solution rotated a pair of microwave and passive-infrared sensors to achieve the required 360-degree coverage with significantly reduced size and cost (Figure 164).

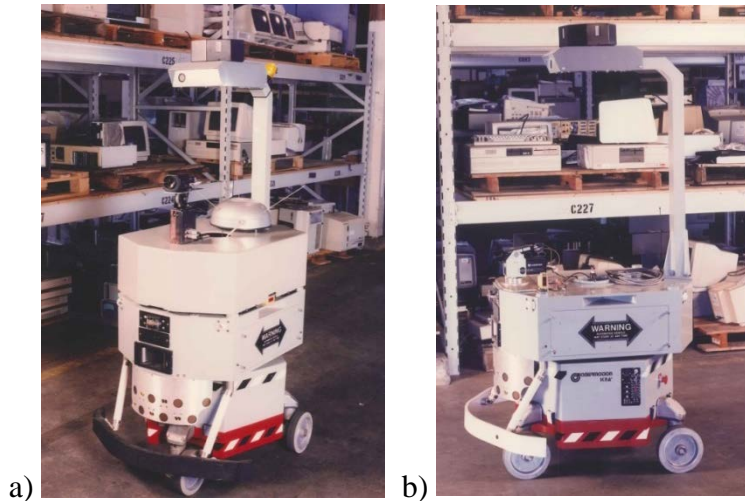

Figure 164. a) The initial Savi RFID tag reader (silver dome) is atop the turret behind the camera pan and tilt unit, underneath the Cybermotion *Security Patrol Instrumentation (SPI)* module. b) In 1994, a second *MDARS* prototype was installed in the NOSC excess-property warehouse at Camp Elliott, after which the two robots operated 24/7.

In addition to providing component technologies to enhance the *NavMaster*, NOSC was tasked by PSEMO with developing a command-and-control architecture for coordinated oversight of multiple robots. Prior to this point in UGV history, for every mobile robot there was some dedicated remote computer serving as its one-on-one operator interface. The *MDARS* concept envisioned up to 32 security robots at any given installation, however, and that many stove-piped control stations at the site's guard post was clearly impractical. A high-level conceptual design for a modular robotic architecture that could handle this workload was subsequently conceived, possibly the first ever instantiation of multiple-robot control (Everett, Gilbreath, & Laird, 1992).

Implemented by Gary Gilbreath and Robin Laird, the command-and-control solution provided supervisory oversight of intelligent semi-autonomous security robots geographically distributed across the area of coverage. The origins of this approach trace back to then Lieutenant Commander Everett's *ROBART I* thesis at the Naval Postgraduate School (Everett, 1982):

“A central monitoring station could be alerted via a digitally coded radio transmission that an intruder had been detected, subsequently setting off the building security alarm, and possibly notifying police. This monitoring station could perhaps keep track of several robots patrolling on different floors, or in different areas of a large industrial plant. Each robot could periodically transmit its location and status, thus providing a means for the central station to be alerted should a robot become disabled. Human guards or other robots could then be dispatched to the scene to evaluate the situation.”

Specifically designed to meet this objective (Everett, Gilbreath, Laird, & Heath-Pastore, 1993; Everett, Gilbreath, and Heath, 1993), the *Multiple Robot Host Architecture (MRHA)* was a distributed processing system intended to run automatically with minimal human supervision (Figure 165). Guard intervention was required only when a patrolling robot encountered an unusual condition such as an environmental hazard or a security breach. Such “exceptional events” were prioritized and displayed to the guard for action. When the Savi RFID interrogator was found to be more appropriate for *MDARS* needs than the Amtech system, NOSC was further tasked by PSEMO to develop the

Product Assessment System (PAS) extension shown within the dashed lines in Figure 165 (Smurlo et al., 1995).

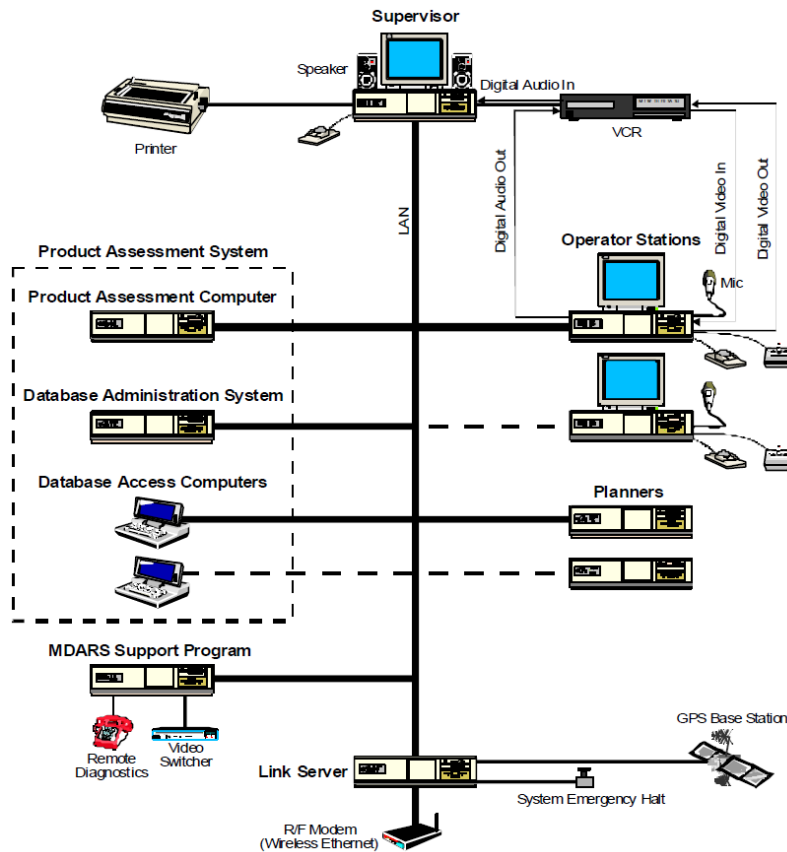

Figure 165. The NOSC *Multiple Resource Host Architecture (MRHA)* for the *MDARS-Interior* program is thought to be the first command and control architecture able to oversee and direct multiple unmanned systems (Laird et al., 1993). Later advances in multitasking and processor performance allowed the *MRHA* to run on a single computer.

From the outset, Commander Everett had petitioned PSEMO to let NOSC develop the *MRHA* so the government could retain full rights (Everett, 1997):

“In summary, reducing the scope of the contract to only that element the government truly needs increases competition, simplifies the RFP process, simplifies the source selection process, maximizes effective utilization of limited funds, seriously reduces technical and programmatic risk, and saves the tax payer’s dollars.”

In light of the long-established DoD policy of picking a lead systems integrator from the industrial sector, such an unorthodox approach was not an easy sell, but in more recent times, the pendulum has clearly swung the other way. The Weapon Systems Acquisition Reform Act of 2009 led the Service branches to rely more heavily on federally funded research, development, and engineering centers for the integration of mature technology solutions. Most program managers today insist on a Government-rights open architecture, an acquisition strategy pioneered some 25 years ago by the *MDARS* program.

At the time, the *Multiple Resource Host Architecture* represented an optimal command-and-control solution in terms of a minimal hardware configuration without significant performance tradeoffs. High-level status (for all robots) was presented via the Supervisor display (Figure 166), while detailed operational/diagnostic information (for a selected robot) appeared on the Operator Station (Figure 167). The initial *MRHA* prototype was configured with one Supervisor Station, one Operator Station, two Planners, and one Link Server for coordinated control of up to 32 robots (Laird, Everett, & Gilbreath, 1993; Gage & Hower, 1994).⁴¹ The Product Assessment System was added to the baseline configuration in 1995 (Inderieden, Everett, Heath-Pastore, & Smurlo, 1995).

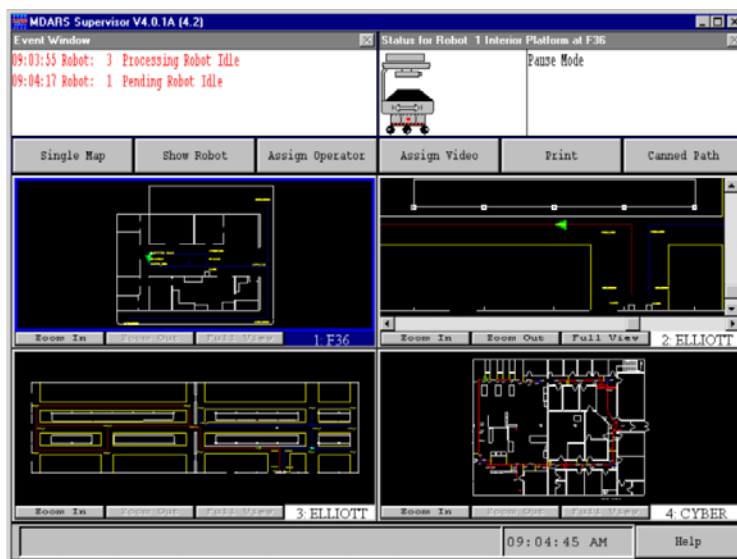

Figure 166. The Supervisor computer automatically displayed the four most relevant robots,⁴² which were tracked in real time on their respective floorplan maps: 1) Building F-36 at NOCS, 2) Camp Elliott warehouse (middle bay), 3) Camp Elliott warehouse (south bay), and 4) Cybermotion facility in Roanoke, VA.

The significance of any "exceptional events" sensed by the patrolling robots was assessed by the *MRHA*, based upon robot sensor and status information, with operator assistance invoked as needed via automatic assignment to an Operator Station (Figure 167). When the security-assessment software indicated a valid threat condition existed, an appropriate response was initiated by the guard-force watchstander. Nonthreatening events, on the other hand, were handled with minimal if any human involvement (e.g., autonomously navigate around an obstruction).

A *Network Enabled Resource Device (NERD)* installed in a manned response vehicle investigating a perceived threat allowed the dispatcher to follow the response team's progress on the Operator Station (Carroll, Everett, Gilbreath, & Mullens, 2002). The dispatcher could also hand off control to a remote Operator Station situated inside the response vehicle, allowing the on-scene team to view video from and locally control the *MDARS* robot in cooperative fashion (Carroll, Gilbreath, Grant, & Day, 2003).

⁴¹ The ability for the *MRHA* to also control outdoor robots was incorporated under the *MDARS-Exterior* program in 1993 (Heath-Pastore & Everett, 1994).

⁴² The security guard could also zoom full screen on any one map by clicking the Single Map button at upper left.



Figure 167. An Operator Station could be automatically assigned to any specific robot when the detailed attention of a guard was required, allowing the supervisor to allocate both computational and human resources in response to exceptional events (Everett, Heath-Pastore, & Hower, 1994).

MDARS in all probability was the first supervised autonomous robotic installation to run 24/7 for extended periods of time. Simultaneous control of two *MDARS* robots patrolling nightly within an unstructured warehouse environment was demonstrated for more than 2 years at a beta-test facility installed in NOSC's Camp Elliott warehouse in San Diego, CA (Figure 168a). To establish a navigational baseline in a structured (hallway) environment for comparison with warehouse performance, an improved second-generation prototype was simultaneously tested in the basement of Building A33 Topside at NOSC (Figure 168b). Cybermotion soon introduced their comparable commercial product as the *Security Robot 2 (SR2)* shown in Figure 168c (Holland, Martin, Smurlo, & Everett, 1995).

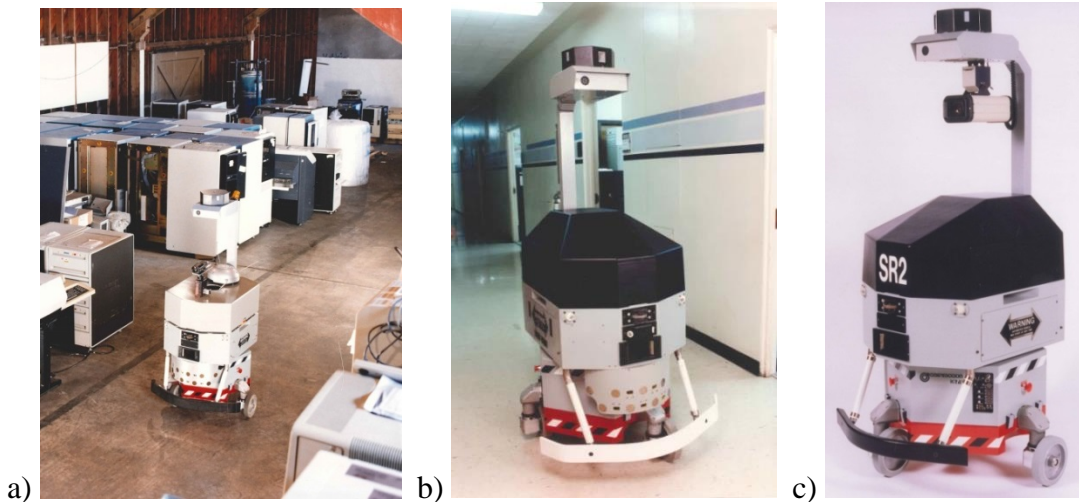

Figure 168. a) One of two *MDARS* prototypes, circa 1994, that patrolled the Camp Elliott warehouse during an extended evaluation. b) To establish a navigational baseline and identify potential failure modes, a third robot patrolled nightly in Building A33 at NOSC, circa 1996. c) The comparable Cybermotion first-generation *SR2* commercial version had a video pan-and-tilt unit mounted beneath the *SPI-01* security payload (top center).

In September 1994, the Cybermotion portion of the CRDA transitioned to an Army Broad Agency Announcement (BAA) contract to develop an improved intruder-detection payload. The company's initial *Security Patrol Instrumentation (SPI-01)* payload was completely redesigned by Dave Fisher to include an integrated camera pan-and-tilt mechanism. The cylindrical lower housing shown in Figure 169a enclosed the tilt axis and rotated with the pan axis to mask camera movement that would otherwise interfere with the Doppler motion detector. On the commercial side, Cybermotion subsequently introduced their second-generation *SR2* configuration with the *SPI-02* payload (Figure 169b).

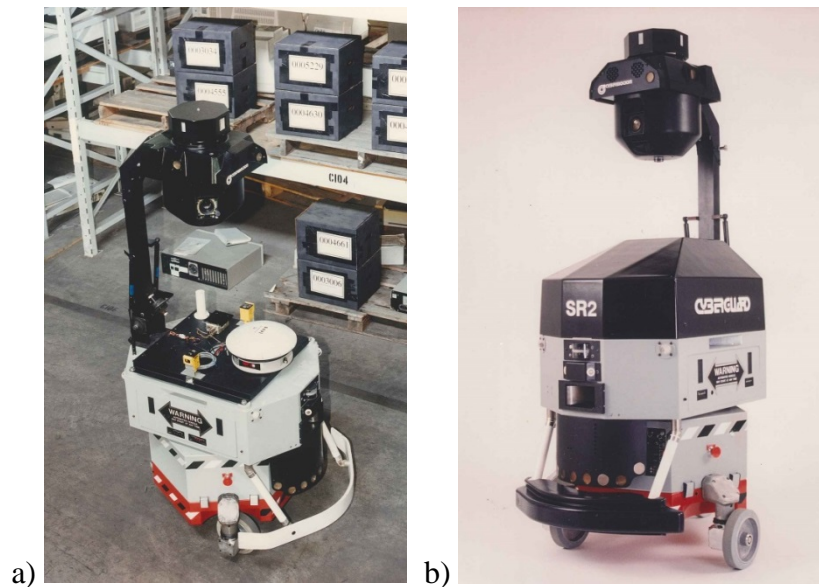

Figure 169. a) The improved Cybermotion *SPI-02* and the Savi RFID interrogator payloads during testing in the NOSC Camp Elliott warehouse, circa 1995. b) The comparable second-generation Cybermotion *SR2 CyberGuard* commercial robot with the *SPI-02* security payload.

The second round of Technical Feasibility Testing (TFT-II) was conducted at Camp Elliott in San Diego in February 1997 (TFT, 1997). Since the new *SPI-02* payload reflected years of concept development and optimization (under *ROBART II*, the NOSC/Cybermotion CRADA, and the BAA contract), the forthcoming security-assessment evaluation was viewed as relatively low risk. The far bigger challenge was autonomous navigation in a working warehouse environment (Everett et al., 1984). The wide-angle Cybermotion sonars were good at detecting obstacles in front of the robot, but often lacked sufficient angular resolution to find a clear path in cluttered surroundings as shown in Figure 170 (Everett, 1995b).



Figure 170. Exhaustive collision-avoidance scenarios were tested during TFT-II to ensure the Cybermotion and NOSC sonar arrays provided proper detection and circumnavigation of all obstacles. The yellow sensors detected retroreflective-tape markers on support columns along the aisle for improved localization (Borenstein, Everett, and Feng, 1996).⁴³

Originally developed on *ROBART II*, the complementary narrow-beam sonar array did a much better job identifying clear pathways the robot could traverse (Everett, 1995b). As shown in Figure 171, for example, range and bearing data from the Polaroid sonar array, mounted under the *Navmaster* turret above and behind the tactile bumper, caused the robot to deflect to the left of the stepladder for safe passage through a narrow pathway. Without this higher resolution narrow-beam sonar input, the collision-avoidance software would have concluded the aisle was completely blocked, preventing the robot from continuing its assigned patrol segment.

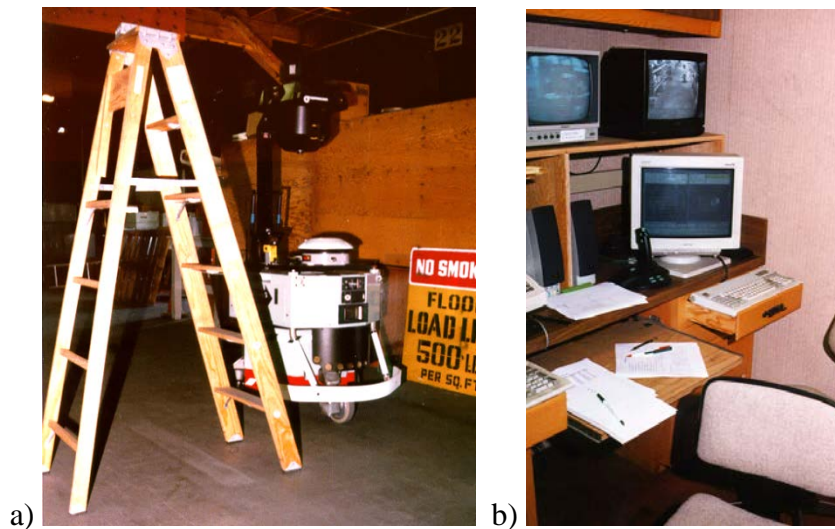

Figure 171. a) The robot properly concluded it could not go through the perceived opening under the ladder and altered course accordingly to the left. b) The *MRHA* command-and-control console was set up inside an air-conditioned container van outside the Camp Elliot warehouse for continuous 24/7 testing.

⁴³ U.S. Patent No. 5,812,267 was awarded to H. R. Everett, G.A. Gilbreath, R.S. Inderieden, T.T Tran, and J.H. Holland for this optical localization concept on 22 September, 1998

TFT-II testing at Camp Elliot was initiated, monitored, and recorded from the *MRHA* console in an outdoor air-conditioned container van (Figure 171b), with PSEMO-designated observers taking notes inside the warehouse (Figure 172a). The robot successfully executed each collision-avoidance test scenario with no human intervention, thereby achieving a perfect score for this event. In addition, extensive tests were conducted to evaluate the Intrusion Detection System and Product Assessment payloads (Figure 172b), with specific metrics collected on false alarm rate, nuisance alarm rate, probability of detection, and product status verification (TFT, 1997).

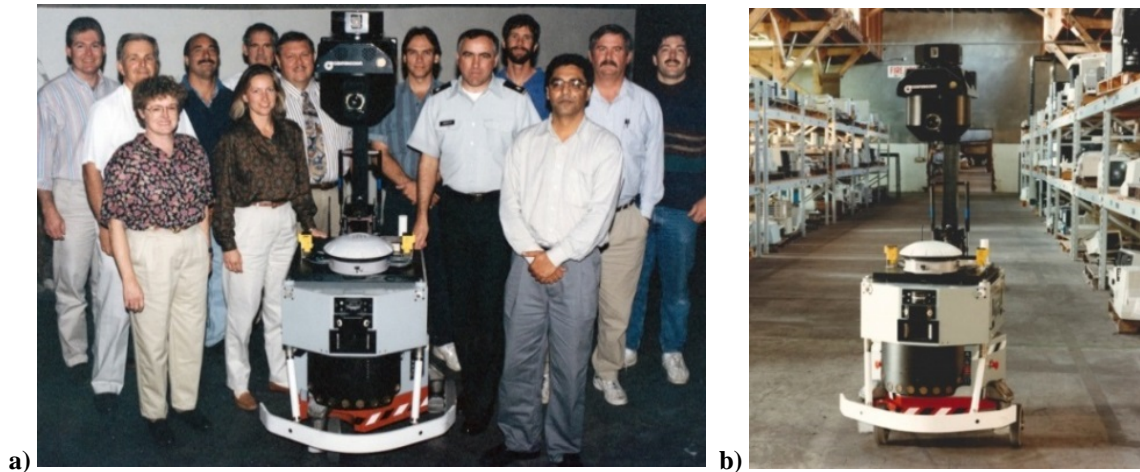

Figure 172. a) Representatives of the *MDARS* team in the Camp Elliott Warehouse during TFT-II (left to right): Brendan Smith, John Bott, Dori Jaffee, Steve Timmer, Tracy Pastore, Doug Murphy, Jerry Edwards, robot, Larry Drymon, Lieutenant Colonel Bruce Swagler, Gary Gilbreath, “Ish,” Bart Everett, and Jeff Garwood. b) The Intrusion Detection System (*SPI-02*) and Product Assessment (RFID interrogator) payloads were tested on warehouse patrols.

In 1997, a pair of *MDARS Interior* robots was installed within the Defense Logistics Agency (DLA) warehouse at Anniston Army Depot, AL (Newsome, 1998). Considerable effort was spent debugging this installation at Anniston while still developing code on the fly (Figure 173), as the Army needed to expedite the schedule to secure continued funding. Bart Everett divided his team into two groups that alternately travelled every other week, which he supervised on each trip. These teams worked on the warehouse installation from 0600 to 1530 when the local workers locked up, wrote and debugged software in the adjacent *MDARS* trailer until 1730, then relocated to the Guard Shack for several more hours on the control console.



Figure 173. Electronics technician Steve Timmer of Code D371 worked long hours on multiple bi-weekly trips to Anniston installing and maintaining the two *MDARS-Interior* robots in the DLA warehouse. Invaluable assistance was also provided by John Holland and his engineering support team from Cybermotion.

Early User Appraisal (EUA) of the *MDARS-Interior* program began in November 1997, during which the two robots patrolled the warehouse for another 8 months (Newton, 1998). The security guards of the Anniston Army Depot police force each received 2 hours of operator training from Robin Laird (Figure 174a), which heralded the first time the *MDARS-Interior* system was in operational mode under actual user control (Figure 174b). Some 14 demonstrations were held for various DoD and DLA officials during EUA, all successful, with the final event hosting some 75 members of the Physical Security Equipment Action Group.

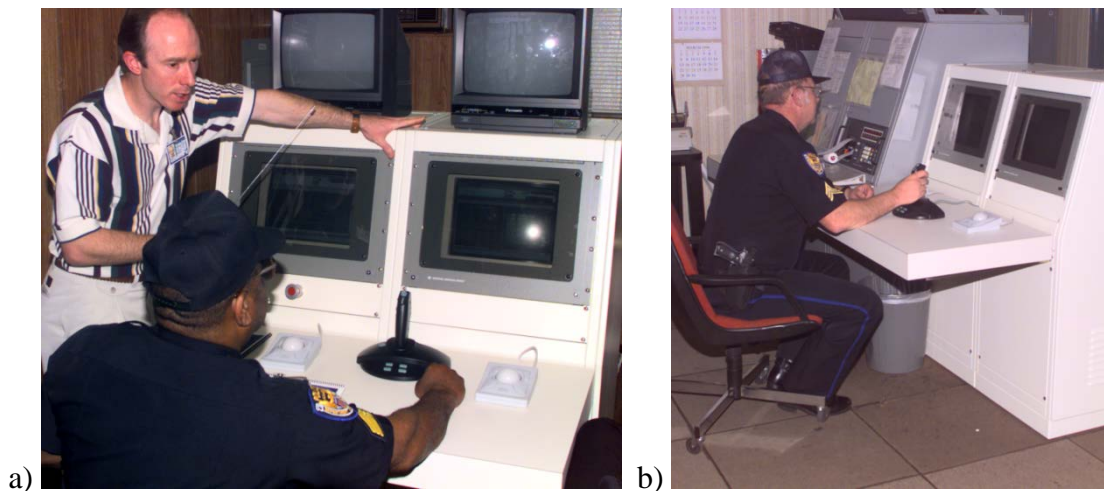

Figure 174. a) Robin Laird prepared and individually presented the *MDARS* operator training syllabus to the guard force at Anniston Army Depot. b) The local guard force then took over control of the *MDARS* robots in the remote DLA warehouse for the duration of Early User Appraisal.

In April 1999, the Army Program Office awarded an Engineering Manufacturing Development (EMD) contract to General Dynamics Robotic Systems (GDRS), formerly Robotic Systems Technology (RST), Westminster, MD. The GDRS proposal had included the Cybermotion *K2A* platform with the *SPI-02* security payload, which had been extensively tested during EUA in the DLA warehouse at Anniston Army Depot. When Cybermotion replaced their *K2A* platform with the newer *K3A* version, however, GDRS amended its contract to delete the *K2A* platform and specify this newer model.

The resulting *MDARS-Interior* System Development and Demonstration (SDD) platform (Figure 175a) was based upon a *K3A SPI-Master* outfitted with *MDARS*-specific subsystems in support of two primary missions: 1) patrol a pre-specified area and check for intruders, and 2) read RFID tags affixed to sensitive or high-value inventory. Mission modules included an intrusion-detection payload that fused microwave and passive-infrared motion sensors, a video camera for surveillance, and a Savi tag reader for inventory assessment. Obstacle avoidance was supported with ultrasonic sensors, two scanning lidars, and a tactile bumper.

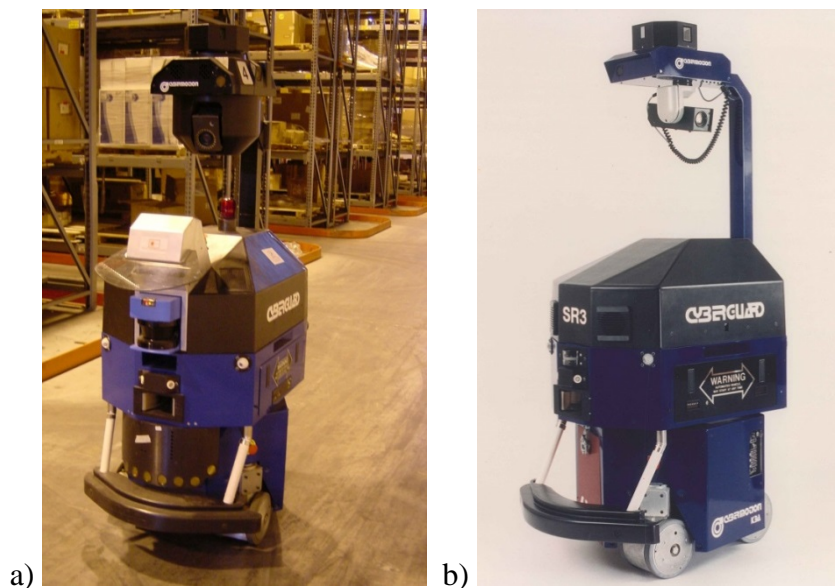

Figure 175. a) The *MDARS-Interior* SDD system, based on the *K3A* platform and the *SPI-02* security-sensor payload, underwent Limited User Testing (LUT) at Susquehanna Army Depot, PA. b) The corresponding Cybermotion Cyberguard SR3 commercial product consisted of its *K3A* platform equipped with the *SPI-01* payload.

In February 2001, the *MDARS-Interior* system began LUT at Susquehanna Army Depot, PA (Everett, 2003). This evolution evaluated the same system functionality addressed at the Early User Appraisal at Anniston Army Depot in 1997, but with a greater emphasis on product assessment. In 2003, however, Cybermotion unfortunately discontinued operations and disbanded,⁴⁴ whereupon the Army Program Office placed the *MDARS-Interior* program in abeyance, as user interest had shifted more towards exterior applications. The development history of the interior security-robot concept over a 22-year timeframe is graphically depicted in the poster reproduced as Figure 176.

⁴⁴ Cybermotion's patented *Synchro-Drive* transmission provided extremely accurate dead-reckoning capability to their omni-directional mobility base, but was rather expensive to produce. The advent of laser-based localization schemes allowed far less precise mobility solutions to be used, resulting in lower-cost commercial alternatives.



Figure 176. The evolution of the interior security robot began with *ROBERT I* in late 1980 and progressed through several phases of increased sophistication over a span of 22 years. While DoD never fielded such robots indoors, the underlying technology was repurposed for far greater return on investment under the *MDARS-Exterior* project.

***ROBART III* (1992–2007)**

Like its predecessors, *ROBART III* was a laboratory surrogate, never intended for real-world operation (Figure 177): 1) it was not waterproof; 2) its mobility was constrained to planar surfaces, so it could not ascend or descend stairs; 3) it was not defensively armored; 4) it was not rugged; and 5) it could not right itself in the event it flipped over. Instead, *ROBART III* was a concept/software-development platform built in Bart Everett's garage, optimally configured to support a development role in a laboratory environment. The continuously evolving prototype made many contributions to the field of both supervised and fully autonomous robots, to include perception, localization, navigation, and response (Ciccimaro & West, 1998).

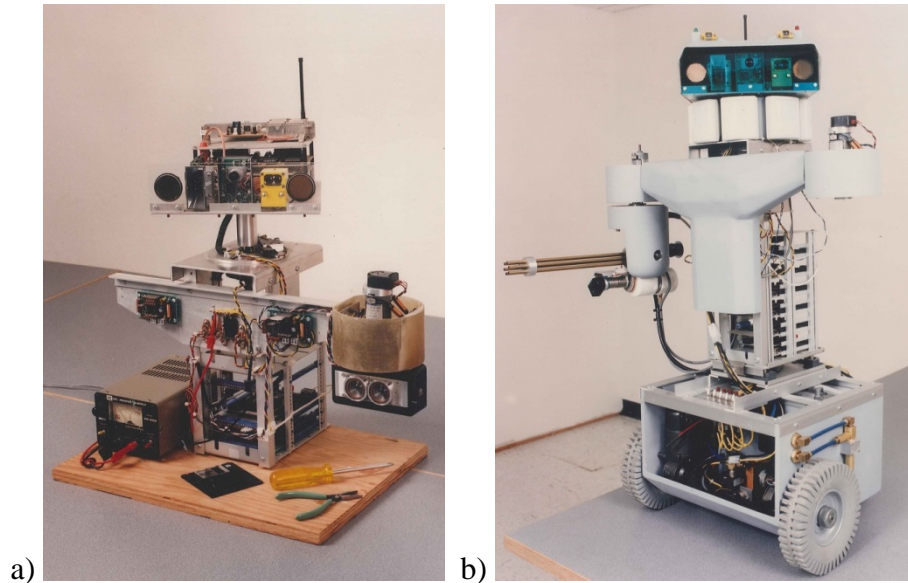

Figure 177. a) This 1992 photo of *ROBART III* shows the 6502-based video motion detector developed under *ROBART II* atop the head, with its pin-hole camera midway between the two head-mounted sonar transducers. b) The central card cage has been vertically extended to accommodate more single-board computers, circa 1995.

Numerous hardware upgrades were made during *ROBART III*'s 15-year lifetime in support of more sophisticated navigation, collision avoidance, and mapping schemes, to include a MicroStrain gyro-stabilized magnetic compass, a KVH fiber-optic rate gyro, and a 2D Sick *LMS-200* scanning lidar (Figure 178). Full-duplex data communication with the PC-based control station was accomplished via a 9600-baud Telesystems spread-spectrum RF link. The 12-volt ABEC drive motors were identical to those used on *ROBART II*, but equipped with higher traction snow tires (Figure 177b). System power was supplied by an 80-amp-hour 12-volt gel-cell battery that provided for several hours of continuous operation between charges.

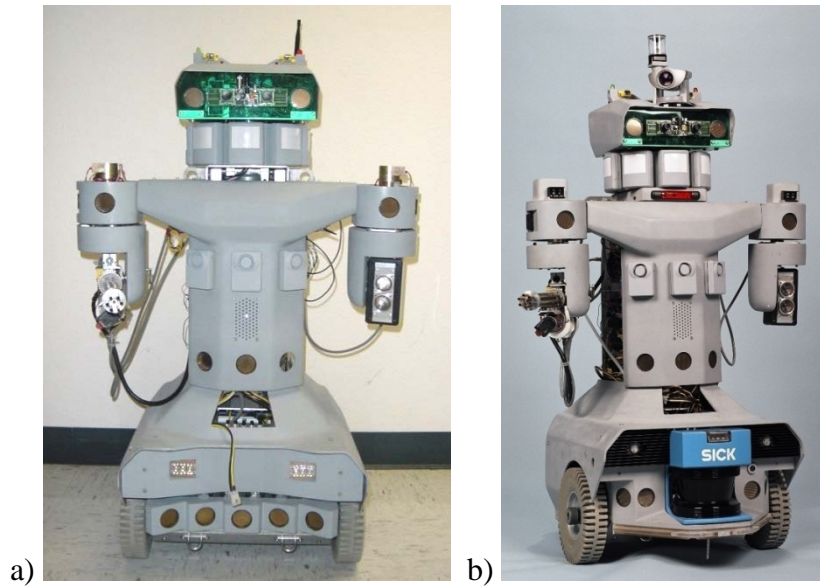

Figure 178. a) Early configuration of *ROBERT III* showing the five-element sonar array on the mobility base, circa 2000. b) The five-element array has been replaced with a four-element array and a 2D Sick lidar incorporated into a front bumper, circa 2002. Note upgraded LED headlights in the black heat sinks above the sonar transducers.

Referring again to Figure 178a, early versions of *ROBERT II* had a temporary black/yellow pigtail hanging from the mobility base for manual battery charging. While the front bumper design shown in Figure 178b was primarily added in 2002 to support the Sick lidar, it also accommodated automatic recharging and tactile sensing as shown in Figure 179. For compatibility with existing battery chargers for *ROBERT I* and *ROBERT II*, the 1-inch aluminum contact strip on the front tactile-bumper segment (image top center) served as the negative recharging contact. Similarly, the descending vertical-spring contact at image center enabled the positive connection.

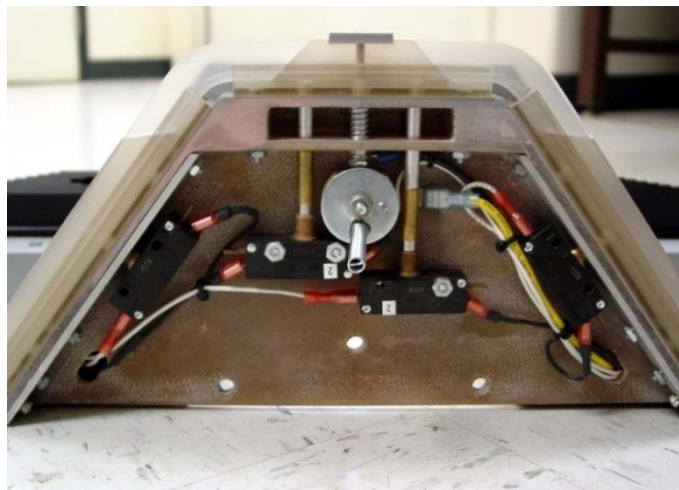

Figure 179. Bottom view of the tactile bumper and Sick lidar support assembly, showing the four black microswitches that sensed bumper-segment contact, the “negative” battery-charging contact on the front bumper segment (top center), and the vertical-spring “positive” charging contact (center). See also Figure 178b.

In the mid-2000s, three 16-bit computers were added to the on-board architecture to support more advanced autonomy (Figure 180): 1) the torso computer processed sonar range data, speech output, and integrated motion of the surrogate weapon and head, 2) the vision computer in the head was processed live video from the omnidirectional and pan-and-tilt cameras and 3) the drive computer in the mobility base controlled the drive motors in response to data from the torso computer, Sick lidar, KVH fiber-optic gyro, and the Micro Strain compass. Multiple 8-bit microcontrollers were still employed for low-level sensor processing and actuator control.



Figure 180. Electronics technician Yuong Sun (left) and electrical engineer Brandon Sights (right) reassemble *ROBART III* following extensive reconfiguration to accommodate the new 16-bit torso computer in 2006.

Intended for concept-development and demonstration, the non-lethal-response weapon shown in Figure 181 was a pneumatically powered dart gun capable of firing a variety of 3/16-inch diameter projectiles (Ciccimaro, Everett, Gilbreath, & Tran 1998). By way of example, simulated tranquilizer darts (20-gauge spring-steel wires terminated with 3/16-inch nylon balls) illustrated a potential response application involving remote firing of incapacitating rounds by military or law enforcement personnel. A rotating-barrel arrangement was incorporated to allow for multiple firings (six) with minimal mechanical complexity. The spinning barrel also imparted a rather sobering psychological message during system initialization.

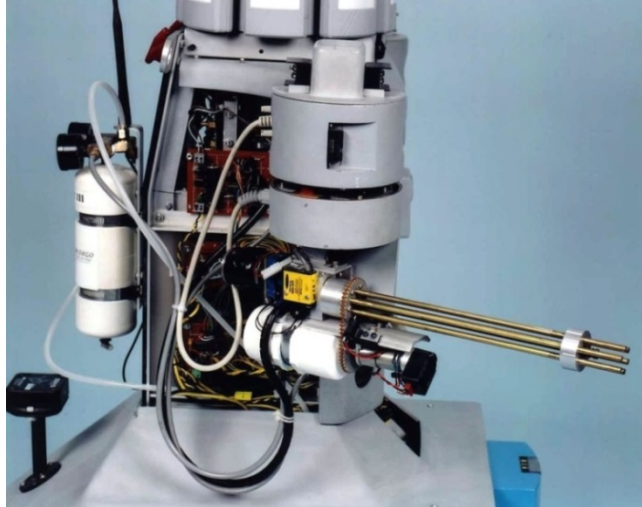

Figure 181. A secondary compressed-air accumulator (bottom center) mounted on the pneumatic non-lethal-weapon prototype was maintained at a constant pressure of 120 psi, replenished automatically from the larger 150-psi accumulator (far left). Note Micro Strain compass on fiberglass pedestal at lower left.

The darts (or steel balls) were fired by a release of compressed air stored in a pressurized accumulator at the rear of the gun assembly. This accumulator was monitored by a Micro Switch *242PC150G* electronic pressure transducer and maintained at a constant pressure of 120 psi by a second solenoid valve (Figure 182). To minimize air loss, the solenoid valve linking the gun accumulator to the active barrel was opened for precisely the amount of time required to expel the projectile. All six darts could be fired in approximately 1.5 seconds under repeatable launch conditions to ensure accurate performance. A visible-red laser gunsight was provided to facilitate manual as well as automatic targeting.

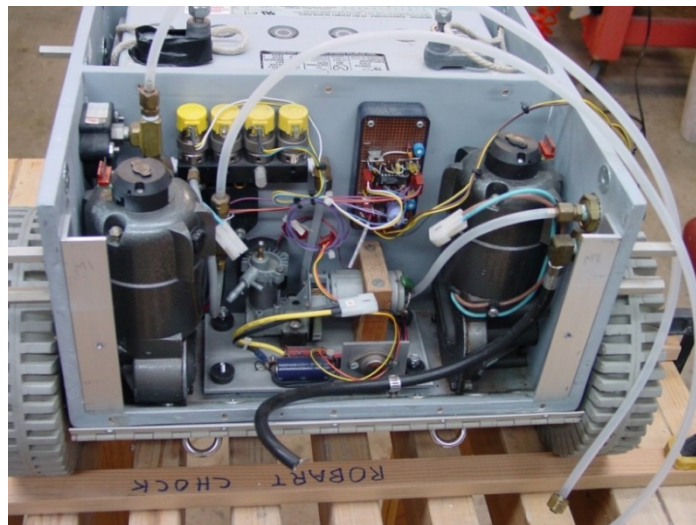

Figure 182. The black electronic pressure transducer for the gun accumulator is on the starboard bulkhead (upper left), with the bank of yellow solenoid valves just to the right on the transverse bulkhead inside the drive-motor compartment of the mobility base. The battery compartment is in the background.

The surrogate weapon was designed for laboratory use only, supporting vision-based weapon control without undue risk to personnel. A fiber-optic sensor on the gun determined load status for each barrel (Figure 183a). A local Ready/Standby switch enabled the air compressor and secondary accumulator charging, and a local Arm/Safe switch physically interrupted power to the trigger solenoid (Figure 183b). There were parallel software disables for both these same functions on the remote OCU. Two separate control lines were employed for the trigger solenoid, one active-high and the other active-low, ANDed together to minimize inadvertent activation during initialization or in the event of a computer reset. Redundant emergency overrides were also provided: 1) two local E-Stop buttons on the mobility base, 2) an RF-kill pendent, and 3) a remote E-Stop button at the control station.⁴⁵

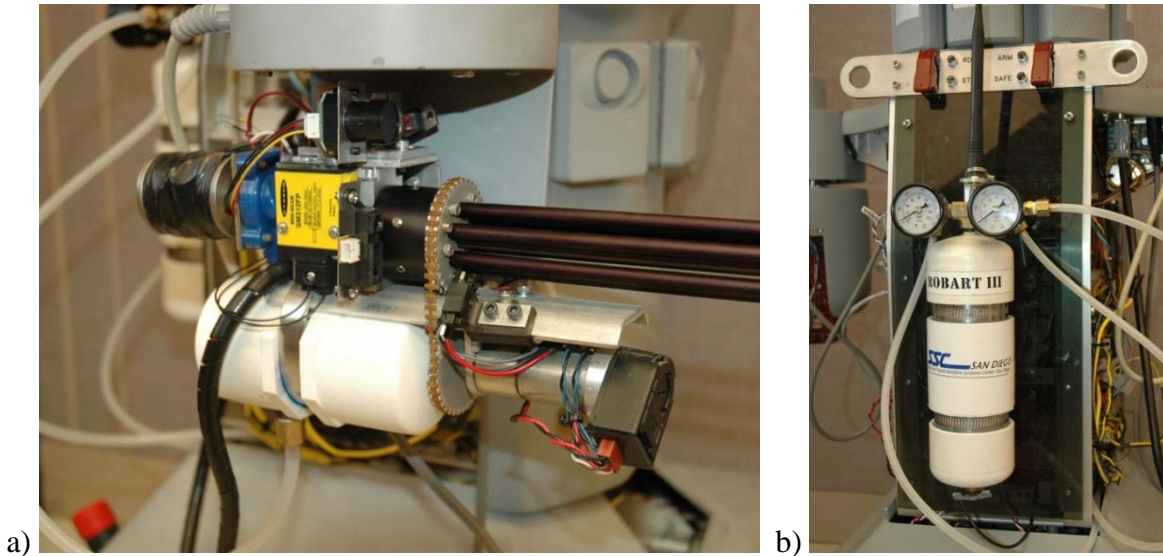

Figure 183. a) The yellow proximity sensor adjacent to the blue solenoid valve was fiber-optically coupled to determine the load status of each barrel as it rotated. Note red E-Stop button at lower left. b) The Ready/Standby switch (upper left) and Arm/Safe switch (upper right) above the main accumulator locally controlled weapon status.

Assisted weapon control, an important new behavior introduced on *ROBART III*, was an extension of the reflexive-teleoperation concept developed on *ROBART II*. The issue of concern was the difficulty encountered when teleoperating a mobile robot equipped with surveillance and/or targeting cameras, plus an articulated weapon system. Experience gained through extended use of conventional teleoperated devices of this type had revealed considerable shortcomings from a man-machine interface point of view. Simply put, if a remote operator has to master simultaneous manipulation of three different joysticks (i.e., one for drive and steering, another for camera pan and tilt, and yet a third for weapon control), the chances of hitting a moving target are minimal.

Our initial approach in addressing this problem involved making two of the three controllable elements (i.e., drive control, camera control, and weapon control) slaves to the third, so the human operator only had to deal with one entity (Figure 184). For example, the head-mounted surveillance camera could be slaved to the weapon so the camera looked wherever the operator pointed the gun. If either the weapon pan-axis controller or the camera pan-axis controller approached their respective limits of travel, the mobility base automatically rotated in place or turned in the proper direction to

⁴⁵ Activation of any E-Stop input device immediately disabled both the weapon and mobility systems.

restore the necessary range of payload motion. Alternatively, the weapon could be slaved to the surveillance camera, and so forth.

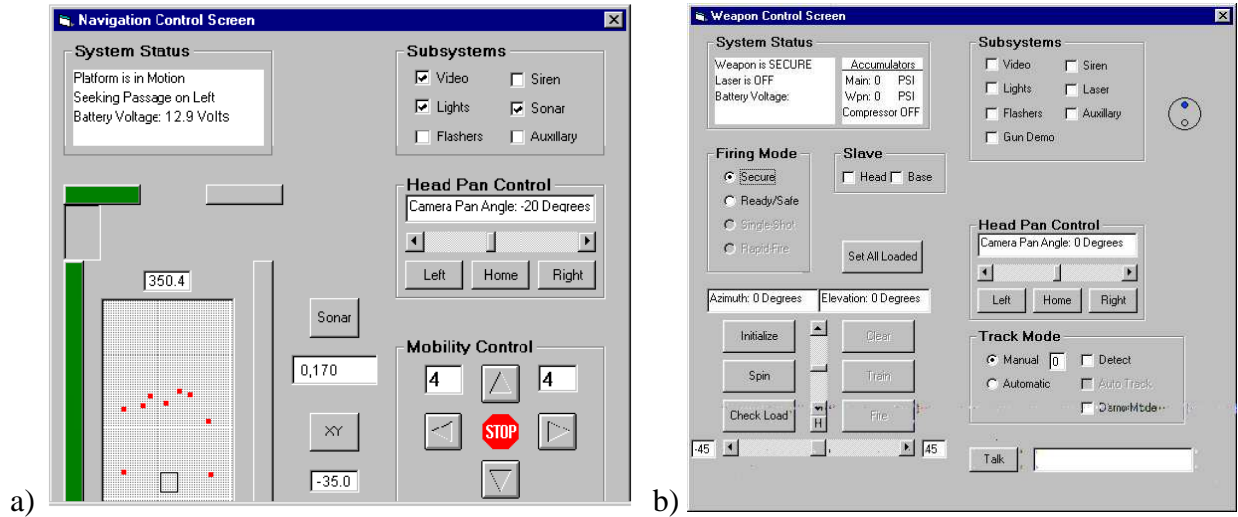

Figure 184. a) The Navigation Control Screen for *ROBERT III*. b) The “Slave” window on the Weapon Control Screen (upper left quadrant) allowed the head pan axis and/or the mobility base to be slaved to respond to pan-axis deflection of the surrogate mini-gun (adapted from Gilbreath, Ciccimaro, & Everett, 2000).

Taking things a step further, final closed-loop control of weapon pan-and-tilt could be provided by the video target-acquisition system. Initial 360-degree motion detection for this behavior was supported by a ring of passive infrared sensors around the neck, an AM Sensors microwave motion detector behind the faceplate, and a Visual Stone omni-directional camera mounted on the head (Figure 185). Fused outputs from these sensors were used to cue a Canon high-resolution pan-tilt-zoom (PTZ) camera in azimuth and elevation, which provided video of potential targets for further assessment and classification. Final closed-loop weapon control was provided by gun-camera imagery.



Figure 185. The head-mounted high-resolution PTZ camera was cued to the location of any suspected disturbance sensed by the 360-degree motion-detection sensors (eight passive-infrared detectors around the neck, the Visual Stone omni-directional camera at top center, and a microwave motion detector behind the face plate).

Our chosen method of object classification inherently possessed a large degree of modularity. If multiple objects were to be detected, then each cascade of weak classifiers could simply be swapped out with a new set that had been trained to detect the current object of interest. The detection efficiency of a trained set of boosted classifiers was sufficient to pass control to another more discriminating detection mechanism without compromising real-time performance. Some possible second-stage detection mechanisms included using the bore-sighted laser to lock on and fire at a confirmed target, or utilizing a text-parser to interpret letters on a license plate or sign (Chen & Yuille, 2004).

The license-plate detection method of Dlagnekov (2005) was investigated to evaluate the *Adaboost* machine-learning/training algorithm for generic object detection (Figure 186), using ordinary soda cans to quantify performance with respect to scale, background clutter, and changes in specularity. To build a training set, the cans were randomly emplaced in a cluttered lab area at a variety of distances and orientations (Figure 186a). Footage from *ROBART III*'s head-mounted camera was captured under three different lighting configurations as three separate MPEG videos, at a pixel resolution of 320 x 240 with a frame-rate of 3 frames-per-second (Kogut et al., 2006).

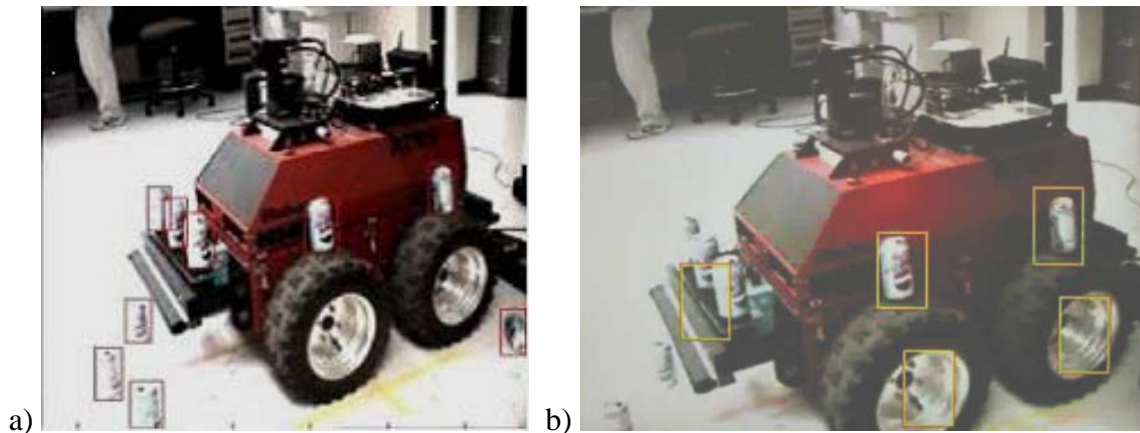

Figure 186. a) Example of an extracted video frame where each actual soda-can region has been manually labeled. b) Example 54 x 83-scale image showing both positive and negative soda-can detections.

Each video was divided into two equal segments, with a portion from each segment pair randomly selected, resized to a resolution of 720 x 480, and extracted as a sequence of bitmap images, which were set aside to build the training set. Soda-can images were manually labeled in every 8th frame of the bitmap training images, then sorted into four separate groups based on their image dimensions (Figure 187a). The remaining portions were merged together and used as test footage for the detection algorithm. Despite a few anomalies, the detection windows shown in Figure 187b allowed *ROBART III* to effectively aim the pneumatically powered weapon surrogate, albeit under ideal laboratory conditions (Kogut et al., 2006).

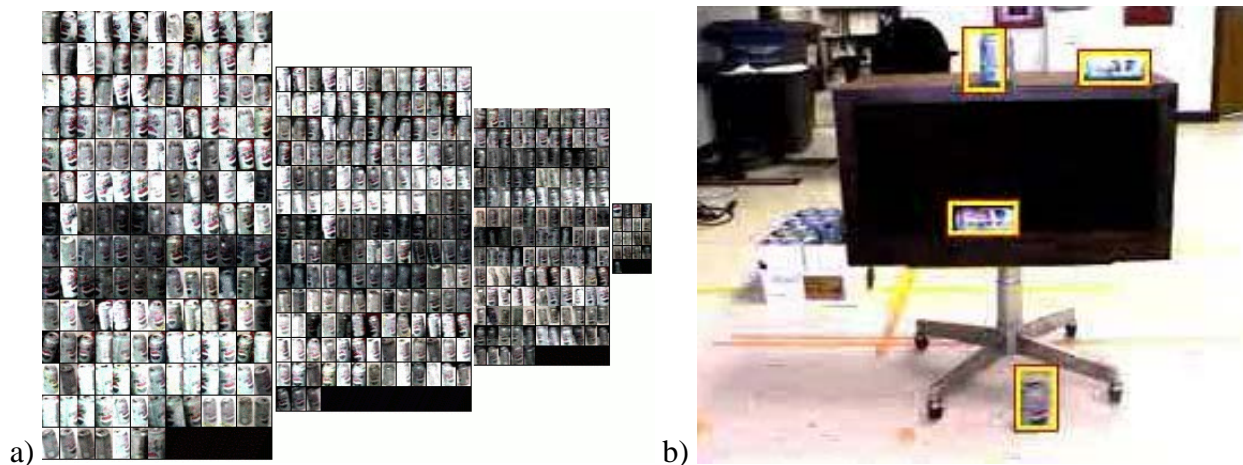

Figure 187. a) A composite representation showing four different scales of acquired training images, where the black areas in the bottom-right regions indicate no soda-can images were present (adapted from Kogut et al., 2006). b) Real-time can detections using recorded footage from *ROBART III*'s camera (adapted from Kogut et al., 2006).

The robot's PTZ camera protocol was later integrated with a two-stage search-and-engage algorithm that performed a wide-area scan for a pre-taught class of objects, then zoomed in to look for specific "vulnerabilities" assigned to that particular target. For the scenario depicted in Figure 188, the sought object was the dark wooden box atop a mobile pedestal shown earlier in Figure 187b, for which the designated "vulnerability" was a soda can inside the box. The surrogate weapon was automatically trained accordingly, using the gun-camera video and bore-sighted targeting laser, then fired under operator supervision.

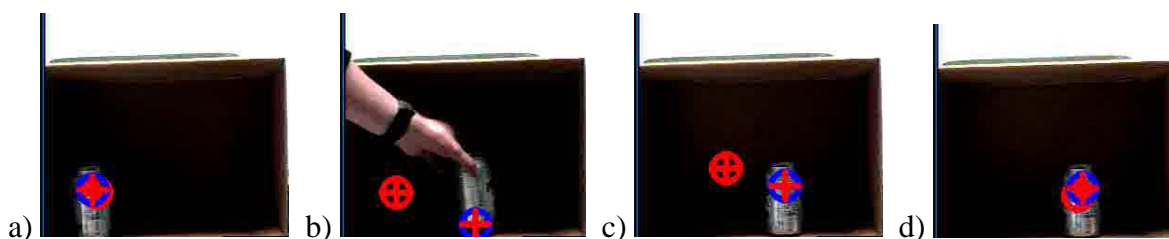

Figure 188. Viewing sequential gun-camera video frames from left to right: a) the laser-sight icon is superimposed upon the initially detected can position; b) the can is then moved to a new location and visually tracked en route; c) the laser-sight icon begins to pursue the can; d) the laser-sight icon comes to rest with the can again targeted.

Detection of the laser spot was disambiguated by grabbing two successive frames of video with the laser sight both on (Figure 189a) and off (Figure 189b), then subtracting the two images to yield a binary difference image. This process continued as the Weapon Controller sent real-time error-based pan-and-tilt velocity commands to reposition the laser spot on target. Note spring-steel darts terminated by plastic balls embedded in the target.⁴⁶ Results of this successful feasibility demonstration were transferred to the *Man-Portable Perimeter Protection (MP3)* and *Networked Remotely Operated Weapon System (NROWS)* projects discussed in later sections.

⁴⁶ Although Figure 189 shows darts, we typically fired 3/16-inch steel balls at the defenseless soda cans.

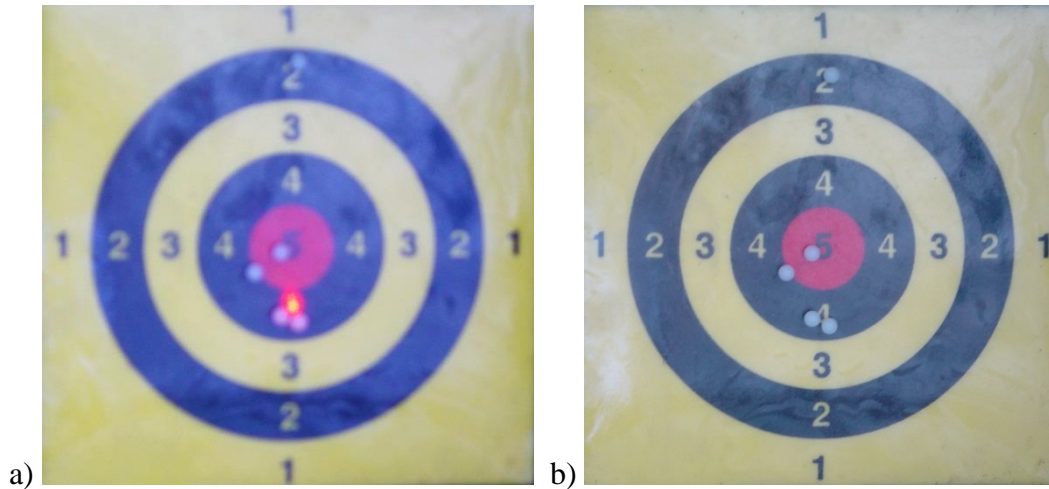

Figure 189. a) The spot of illumination shows up in the video image when the laser sight is on. b) Here the laser sight has been turned off, so the two images can be subtracted to yield the spot location. The Weapon Controller calculated proportional pan-and-tilt commands to progressively move the detected laser spot onto the bulls-eye.

In the summer of 2006, a two-rail surrogate-missile payload that fired rubber-tipped 8.5-inch plastic missiles was added to the left shoulder pod (Figure 190a). Sold as part of a toy rocket launcher, these missiles could attain an altitude of 400 feet, powered by a child stomping on a rubber air bag connected to the vertical launch tube. The addition of this payload required a larger main accumulator, and a higher-throughput mechanical regulator to maintain the secondary accumulator at a constant pressure of 120 psi (Figure 190b). When fired at a 45-degree angle, these surrogate missiles could easily travel about half a block downrange.

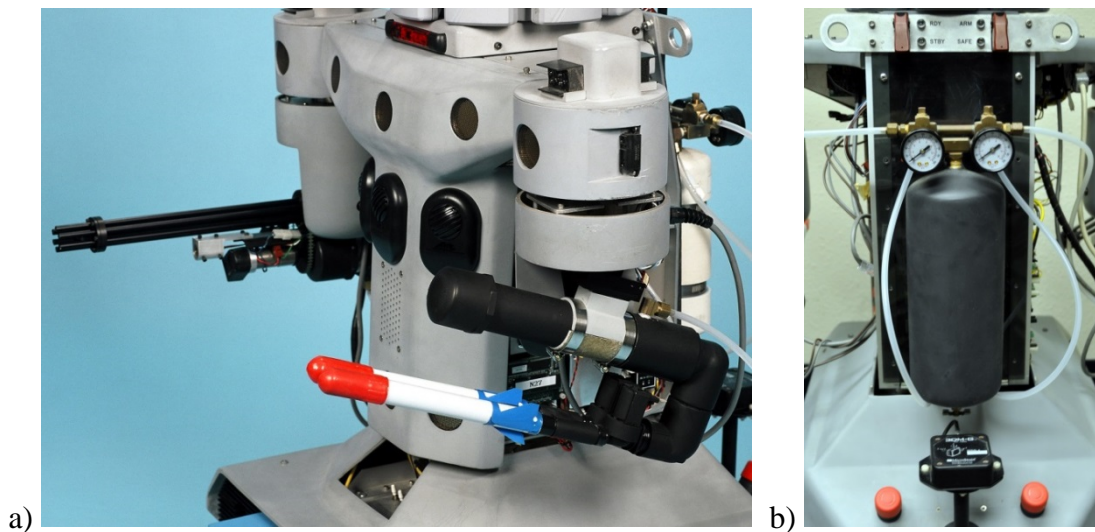

Figure 190. a) The surrogate missile launcher added to the left shoulder mount in 2006 consisted of two plastic rockets on 1/2-inch tubular rails, coupled via quick acting two-stage solenoid valves to a local accumulator immediately above. b) A larger main accumulator and mechanical pressure regulator were added in 2007.

Rather than relying upon a large catch-all object-detection approach, Code 2371 implemented numerous specialized detection methods that could be selectively applied once the robot had established suitable context for their deployment (Kogut et al., 2006). While the traditional approach often views computer vision as a more isolated task, our vision development took full advantage of both the robot's navigational and perception capabilities to simplify the procedure. Figure 191 shows the results of a doorway-detection algorithm that analyzed the SLAM data collected by the Sick lidar during building exploration, with doorway icons inserted into the map representation to flag open doorways that subsequently cued the vision system to look for room signs.

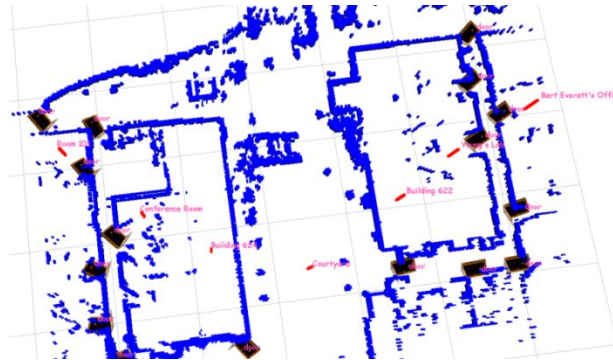

Figure 191. Created in April 2008, this augmented virtuality map of Buildings 622 (right) and 624 (left) shows doorway icons (black rectangles inside brown frames) inserted into the SLAM map representation to mark the perceived location of open doorways as detected by the 2D Sick lidar.

Rather than continuously search the full field of regard for signs from which to extract information, the robot instead optimally positioned itself to investigate the much smaller wall surface to either side of any detected doorway, using the previously discussed boosted classifier to look for a rectangular shape (Kogut et al., 2006). If a suitable shape was detected, the robot would next verify there were characters within this shape, then interpret the sign using optical character recognition (Figure 192). Under this heuristic task-decomposition approach, conditions that significantly enhanced the performance of visual detection were optimally provided by the robot, thereby enabling more intelligent autonomous behavior.

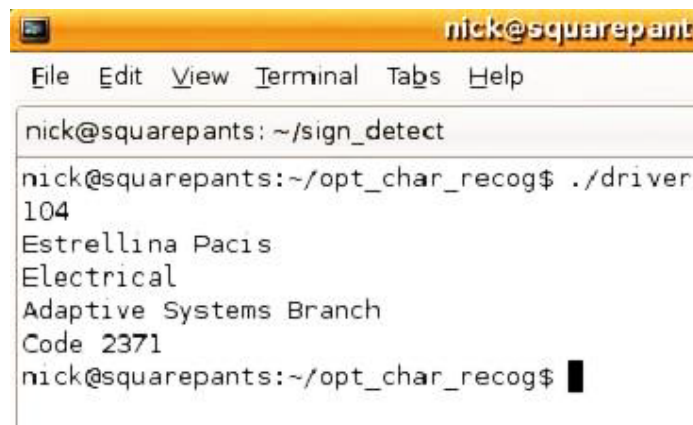

Figure 192. The above information regarding the office room number, occupant, and organizational code was captured by the video camera, which allowed the robot to subsequently respond to voice or e-mail commands such as "go to room 104," or "go to Estrellina's office." See Figure 191.

A natural-language interface allowed *ROBART III* to receive fairly unstructured verbal direction, no different from the procedures used to instruct a human to perform the same task. For example, suppose the robot had penetrated an underground bunker and was streaming back video that showed an open doorway in the center of the far wall. A human monitoring this video might converse with the robot as follows: “Enter the doorway in front of you.” The robot would then look for predefined scene attributes that suggested a door frame or opening, highlighting its choice with a graphic overlay, whereupon the human could confirm or redirect as needed.

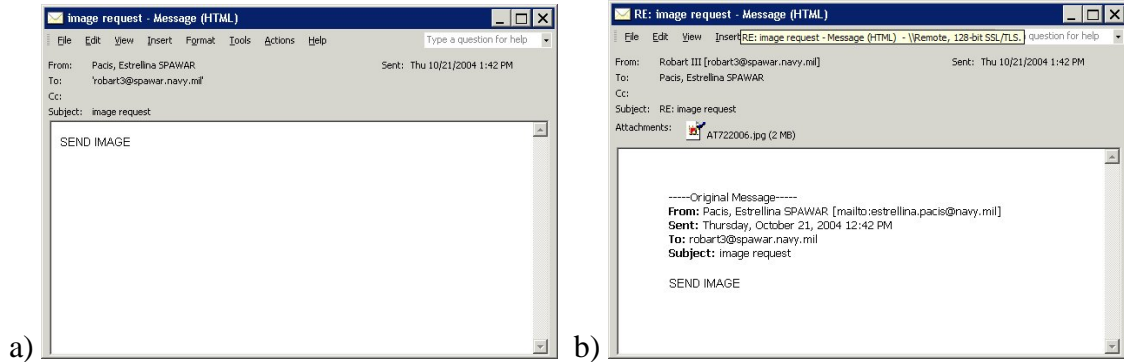

Figure 193. a) Initial e-mail image request from Estrellina Pacis in Building 622 to *ROBART III* in Building 624 dated 21 October 2004 @ 1:42 PM. b) Subsequent response dated 21 October 2004 @ 1:42 PM.

To eliminate voice-recognition problems during the initial stages of development, *ROBART III* was assigned a working e-mail account, thus enabling human-robot interaction via simple text strings, with the added ability to enclose return attachments. Figure 193a above shows an outgoing e-mail request from Estrellina Pacis to *ROBART III* requesting an image dump from the head-mounted PTZ video camera. The automatic response shown in Figure 193b returned a JPG frame grab of the current camera view, in this particular case depicting the robot’s approach to its linear docking station in an adjacent building (Figure 194a). The desired video source and camera pose could be specified by e-mail or automatically determined by the behavior under execution, as in this particular case involving a recharging event (Figure 194b).

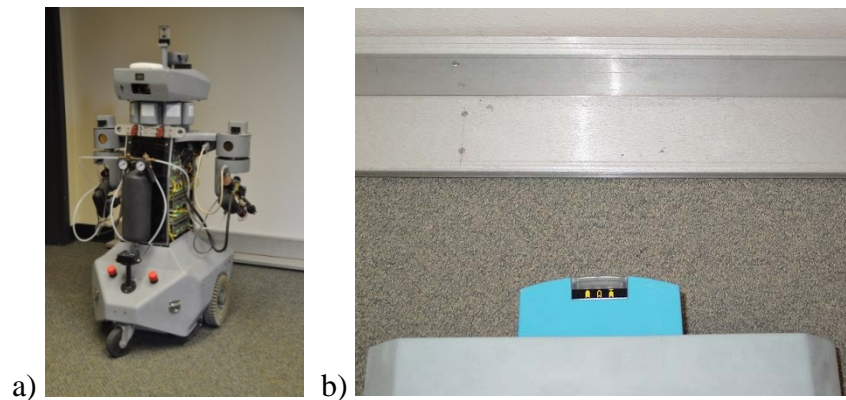

Figure 194. a) *ROBART III* approaches its linear docking station in what is now the museum area of Building 624. b) The returned image shows the PTZ camera looking down at the charging strip. This feature was extremely useful for monitoring performance, as well as for retasking the robot from a remote location.

One of the problems associated with adding autonomy to man-portable robots employed in counter-IED missions is the consequent per-unit price tag. As even the teleoperated EOD robots provided by QinetiQ and iRobot cost over \$110,000 apiece, efforts to provide cheaper (and lighter) alternatives were soon explored by a number of organizations. One option involved the use of radio-controlled toys to deliver an explosive charge that could be remotely detonated to neutralize the IED. The *MARCbot I* was developed by Exponent for the U.S. Army Rapid Equipping Force in 2002, for example (Figure 195a), and the *BomBot* (Figure 195c) was prototyped in 2005 by the Air Force Research Lab (Vickers, 2005; AFRL, 2005).

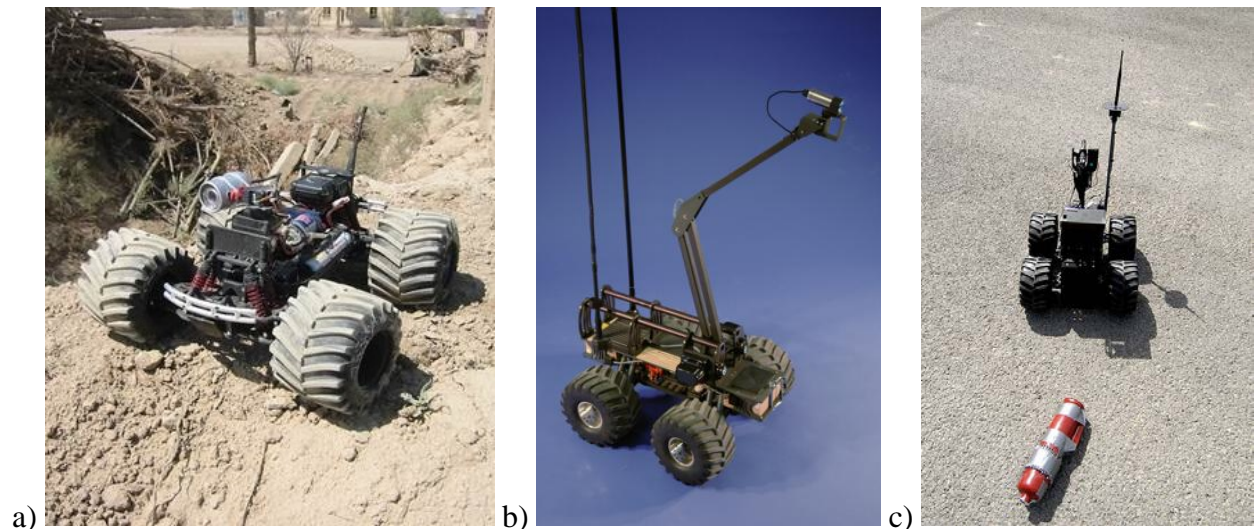

Figure 195. a) Developed by Exponent, the *MARCbot I* was deployed in Afghanistan in July 2002. b) The improved *MARCbot IV* (Exponent, 2016). c) The Innovative Response Technologies *BomBot* was produced for NAVEODTECHDIV under a NAVSEA contract (Lash, 2006).

The basic idea involved remote delivery of a C4 charge that could be ejected onto a suspected IED by a low-cost line-of-sight UGV, then remotely detonated once the R/C UGV had been withdrawn by its operator (USR, 2007). To achieve the necessary operator standoff, however, a video camera had to be added to the system, which required a frame grabber, codec, and upgraded RF link, significantly increasing the cost. The initial \$7000 price tag of a *MARCbot* soon rose to \$15,000, and the unit cost under the NAVSEA contract was reportedly \$45,000 (Stevens, 2006). To get around this problem, we introduced the concept of autonomous teleoperation, which allowed a sophisticated (expensive) robot to serve as a surrogate controller for the expendable R/C vehicle, supervised by a human operator even further away (Figure 196).

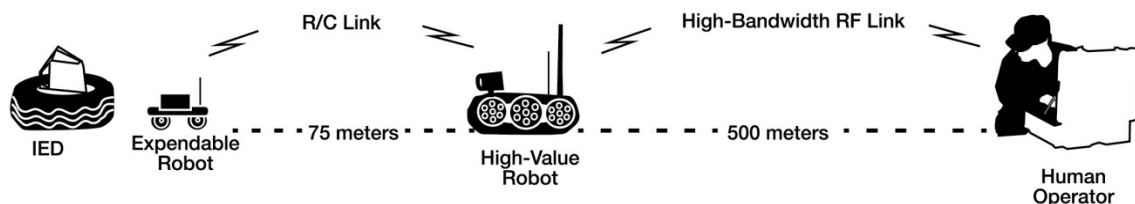

Figure 196. The “autonomous teleoperation” concept involves a low-cost (expendable) robot that emplaces a destruct charge on a suspected IED (left), controlled by an intelligent (high-value) robot some 75 meters away (center), which in turn can be supervised by a remote human operator 500 meters further still (right).

As demonstrated on *ROBART III*, the supervisory human even became optional, essentially allowing the high-value robot to deploy and recover its own sacrificial drone scout (Figure 196b). As the envisioned application for this upgrade was autonomous structure exploration, we decided to use a slave UAV versus a UGV to facilitate mobility in damaged or cluttered environments (Kogut et al., 2006). Initial attempts involved a toy R/C helicopter (Figure 197a), which proved too unstable, so we switched to an R/C blimp (Figure 197b), which although stable, was too susceptible to air currents to be practical. This video-based remote-control software was developed in a matter of days by electrical engineer Greg Kogut using a single-chip RS-232 to R/C converter.

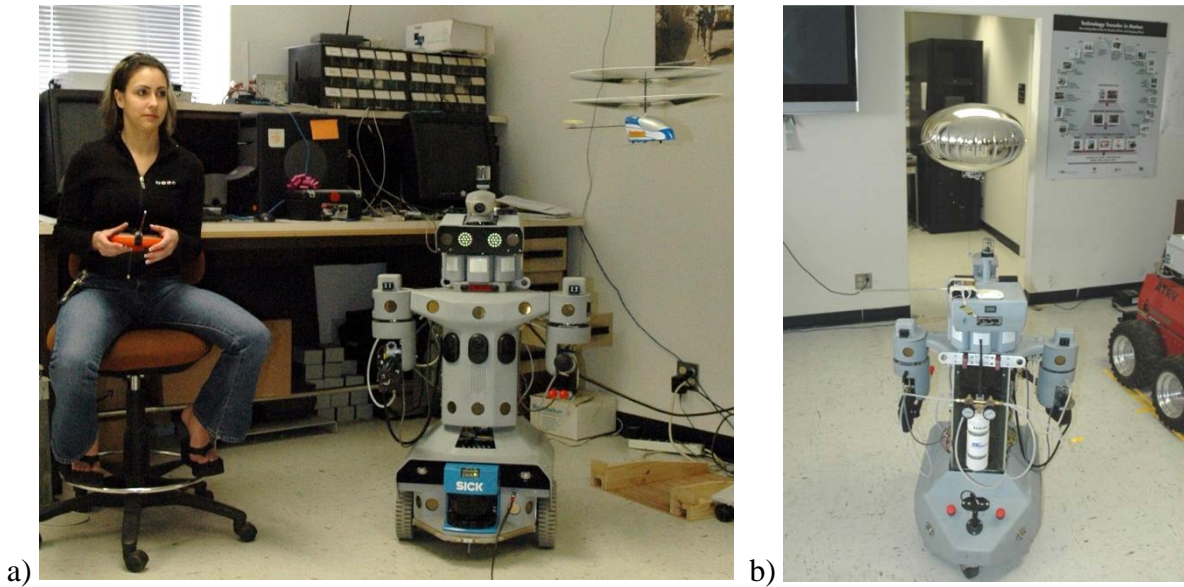

Figure 197. a) Public Affairs Specialist Ann Dakis demonstrates the ability of a previously untrained human to effectively fly an R/C helicopter. b) Using a temporary R/C controller for the blimp taped to the left-rear corner of its head, *ROBART III* visually guides a dirigible towards an open doorway in Building 624, circa April 2006.

In addition to numerous other efforts, *ROBART III* served as a transition platform for the JGRE-funded *Technology Transfer* project managed by Estrellina Pacis (Figure 198), which is further discussed in Volume 2. This multi-year endeavor harvested newly developed component technologies from various sources to increase the functionality and autonomy of man-portable robots (Newton, 2006). Key research thrusts included: 1) enhanced reflexive teleoperation, 2) automated target acquisition and tracking, 3) simultaneous localization and mapping, 4) natural-language understanding, and 5) augmented virtuality.



Figure 198. *Tech Transfer* project manager and electrical engineer Estrellina Pacis (left) works with mechanical engineer Ben Stratton (seated right) to modify *ROBART III* in support of the an upcoming feasibility demonstration.

As one of the more sophisticated mobile-robot research platforms of its time, *ROBART III* was featured numerous times on the *Learning* (Figure 199), *History*, and *Discovery Channels* (Newton, 2006), and in January 2006 was ranked number 16 in *Wired Magazine's* survey of the 50 best robots ever (Anderson, 2006). Dr. John Silva of NOSC had estimated that *ROBART II* probably saved the Navy a million dollars in development costs, and an even greater savings can be attributed to *ROBART III* (Davis, 2011), which served as an application-development surrogate for 15 years. Both systems significantly contributed to the Center's growing reputation as the go-to government laboratory for intelligent unmanned systems.

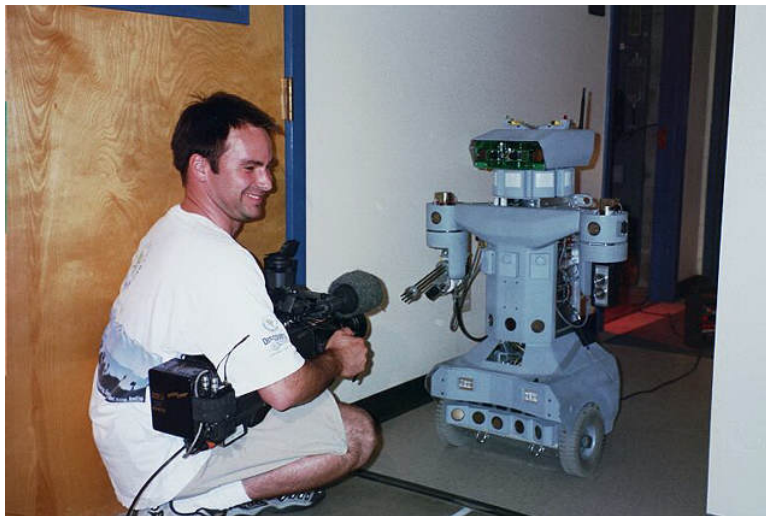

Figure 199. The *Learning Channel* films an early version of *ROBART III* in Building F-36, Seaside, circa June 2001.

Mobile Detection Assessment Response System-Exterior (1992–2011)

The *MDARS-Exterior* program was initiated to extend the robotic-security and automated inventory-control concepts of the *MDARS-Interior* program into the realm of semi-structured outdoor environments (i.e., improved roads and defined fence lines). Typical application sites included storage yards, arsenals, tank farms, airfields, rail yards, port facilities, and airfields. Inventory control consisted of verifying the contents of closed structures (i.e., warehouses, bunkers, igloos) without need for opening, as well as discrete items routinely stored outdoors (aircraft, vehicles, equipment, etc.). A centralized database of high-value inventory was compared with observed inventory as monitored by interactive RFID-tag readers on board the patrolling robotic vehicles.

In 1993, the Army Program Office awarded Robotic Systems Technology (RST), now General Dynamics Robotic Systems, a Broad Agency Announcement (BAA) contract to develop the semi-autonomous robotic platforms capable of outdoor navigation. These *Performance Definition and Risk Reduction (PDRR)* mobility platforms were equipped with on-board payloads for intruder detection/assessment, barrier assessment, and inventory management (Myers, 1994). The *Multiple-Resource Host Architecture (MRHA)* developed by NOSC for command and control of *MDARS-Interior* was upgraded to accommodate exterior vehicles and provided as government-furnished equipment (GFE) as shown in Figure 200.

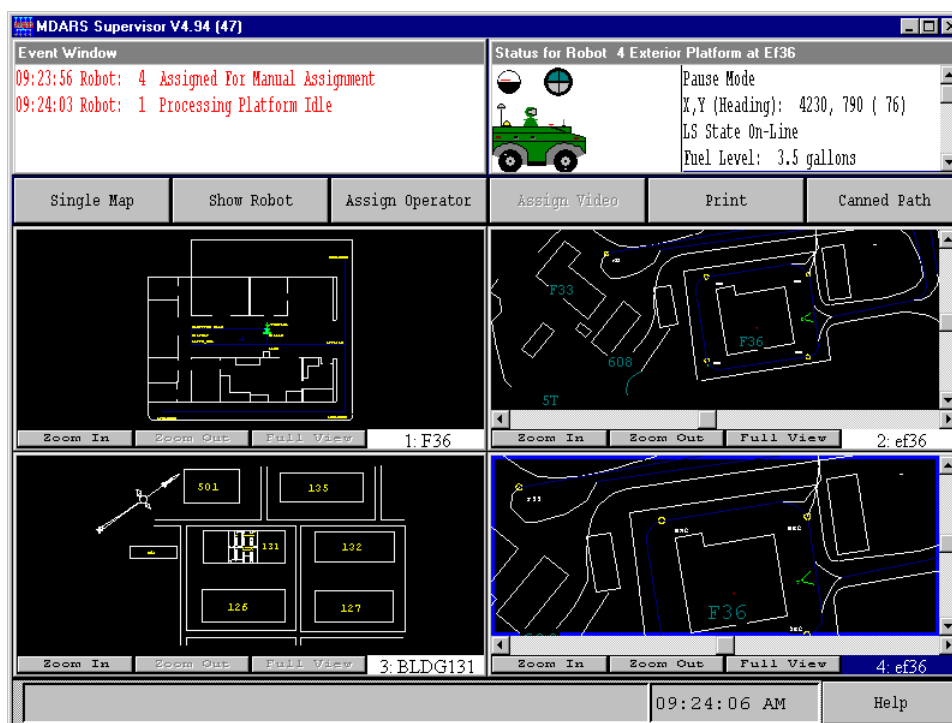

Figure 200. Originally developed for the *MDARS-Interior* robots (screens 1 and 3 at left), the *MRHA* was upgraded in 1994 to also control *MDARS-Exterior* robots (screens 2 and 4 at right) (adapted from Cory, Everett, & Heath-Pastore, 1998).

The design of the *MDARS-Exterior* system was driven by a number of definitive characteristics of the application domain:

- The *MDARS* system had to function as a key component of an overarching security strategy that included fixed-detection systems and human security guards.

- The patrol coverage of multiple mobile robotic platforms had to minimize opportunities for undetected intrusion, even by insider threats.
- The operating environment required navigational capabilities that responded to dynamic events (e.g., pedestrians or other vehicles) in a reasonably structured environment.

Based on commercially available *BobCat* components, the mobility base shown in Figure 201 was a four-wheel hydrostatic-drive, diesel-powered vehicle (Myers, 1995). This BAA prototype weighed 1700 pounds and measured 84 inches long by 35 inches high by 50 inches wide, with an 8-inch ground clearance (Figure 201). Designed by Ron Griffin of Attraction Services under subcontract to RST, the mechanical construction of this custom vehicle proved so rugged and reliable that three such BAA prototypes supported continued UXV development in San Diego for many years. Unlike the cumbersome *GATORS/TOV* retrofit design, all mobility functions (forward, reverse, velocity, steering, and braking) were implemented via hydraulic control of speed and direction.

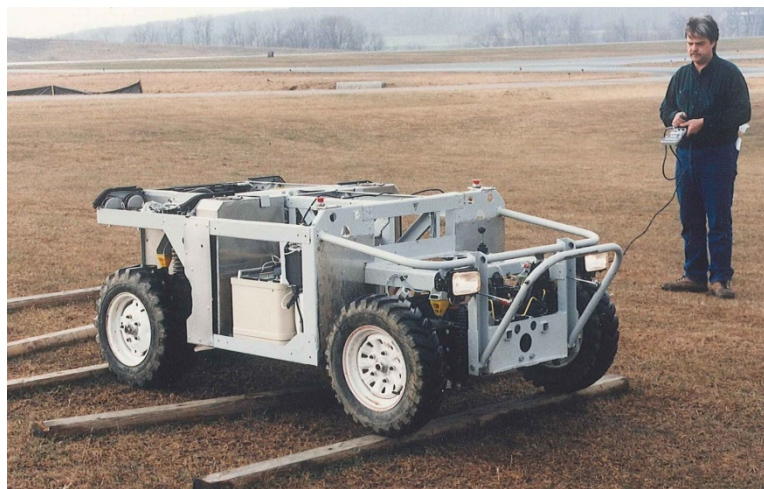

Figure 201. Designed and constructed by Ron Griffin, the *MDARS BAA* mobility prototype undergoes preliminary assessment at RST facilities alongside the Westminster Municipal Airport (background) in Maryland.

For improved dead-reckoning, however, an Ackerman-steered design was chosen over the skid-steer *BobCat* arrangement. With a low center of gravity for maximum stability, the *MDARS-Exterior* vehicle was required to operate over paved, gravel, and unimproved roads at speeds up to 9 miles per hour, while automatically avoiding obstacles and breaches. The four-wheel hydrostatic-drive configuration was powered by a 24-horsepower three-cylinder diesel engine with a 24-volt alternator and integral power steering pump. GDRS demonstrated autonomous navigation of this platform in 1996, with collision avoidance added the following year.



Figure 202. RST vice president Mark Del Giorno evaluates early autonomous GPS-based route execution at the company's Westminster facilities prior to the addition of collision avoidance, circa 1996.

The collision-avoidance strategy incorporated a two-tier layered approach. A long-range (0–100 feet) low-resolution scanning laser provided broad first-alert obstacle-detection coverage, while shorter-range (0–30 feet typical) higher resolution sensors (ultrasonic sensors and stereo vision) were used for more precise obstacle avoidance. The intruder-detection system (IDS) employed millimeter-wave radar (Figure 203) and forward-looking infrared (FLIR) sensors to detect the movement of intruders within a 6.6- to 328-foot range, with 360-degree coverage around the platform (Cory, Everett, & Heath-Pastore, 1998). The product-assessment and barrier-assessment systems used RFID technology to automatically inventory tagged items and interrogate instrumented locking devices on weapon-storage igloos.

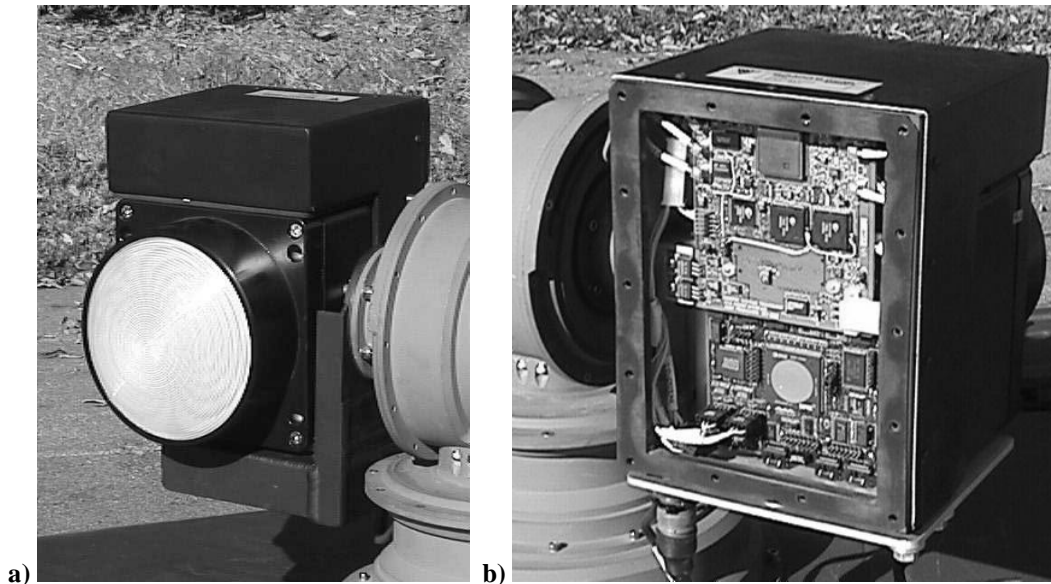

Figure 203. a) Front view of the turret-mounted IDS radar. b) Rear view of the IDS radar with cover removed.

The *MDARS-Exterior* BAA system underwent Technical Feasibility Testing at Aberdeen Proving Ground, MD, during the fall of 1998 (Figure 204). Repetitive test scenarios were run to fully evaluate all aspects of vehicle command and control, real-time localization, collision avoidance, and intruder detection in both daytime and nighttime settings. Acquired by General Dynamics, RST became General Dynamics Robotic Systems (GDRS) in August 1999. In May 2000, a second round of Technical Feasibility Testing by the U.S. Army Aberdeen Test Center (ATC) began at Edgewood, MD. Based upon the results and user input from the Military Police School at Fort Leonard Wood, MO, PM PSE awarded a follow-on contract to GDRS in January 2002 for a System Development and Demonstration (SDD) prototype.



Figure 204. The *MDARS-Exterior* development team at Aberdeen Proving Ground, circa 1998 (left to right: GDRS president Scott Myers, Dr. Peter Burt, Mark Del Giorno, Jay Kurtz, Phil Cory, Brian Frederick, MDARS-Exterior Program Manager Tracy Pastore, Robin Laird, MDARS Technical Director Bart Everett, Kevin Bonner, Bert Farabaugh, Gooitzen van der Wal, and Robbie Mandelbaum).

During this time, SSC Pacific conducted parallel exploratory development efforts to expand the force-protection capabilities of *MDARS*. These included the addition of a non-lethal gun pod and marsupial carriers that could deploy smaller tracked robots and vertical-takeoff-and-landing unmanned aerial vehicles for close-up investigation of off-path incidents. Having served their original purpose, the three *MDARS-Exterior* BAA platforms were turned over to the Unmanned Systems Group in San Diego to support application-payload development for a number of follow-on UGV projects (Figure 205).



Figure 205. *MDARS-Exterior* project manager Daniel Carroll explains the BAA prototype (lower left) to the *History Channel* film crew in front of Building F-36, Seaside in June 2003. A second *MDARS* BAA platform equipped with the *iStar* UAV launch/recovery/refueling payload is shown just inside the building at upper right.

Developmental testing under the System Development and Demonstration (SDD) phase of the *MDARS-Exterior* system took place at the Hawthorne Army Depot (HWAD), the world's largest army depot (147,000 acres), located in west central Nevada (Figure 206). Four *MDARS* vehicles were operated by base security forces for Early User Appraisal (EUA) of the installed system. These "Patrol Unit Vehicles" provided security for 270 storage igloos grouped in 15 bunker sites, as further described by Carroll, Nguyen, Everett, & Frederick (2005). Upon the successful completion of EUA, an *MDARS-Exterior* production contract was awarded to GDRS in 2007.



Figure 206. Jack Gonzales refuels the *MDARS-Exterior* robot during Early User Appraisal at Hawthorne, the world's largest army depot (147,000 acres), circa 2005.

Several factors, particularly system complexity, contributed to significant delays during the first several months of production. To help overcome these challenges, Rachel TenWolde was assigned to provide onsite production oversight at GDRS in 2008. During the next 12 months, she helped implement manufacturing processes to improve inspection, assembly, quality assurance, configuration management, test, and evaluation. She also helped resolve several tense disagreements between GDRS, the Army, and the Defense Contract Management Agency, fostering a more cooperative working environment for all. GDRS completed five *MDARS-Exterior* SDD systems that were delivered to HWAD for safety, performance, and endurance testing in 2009 (Figure 207).

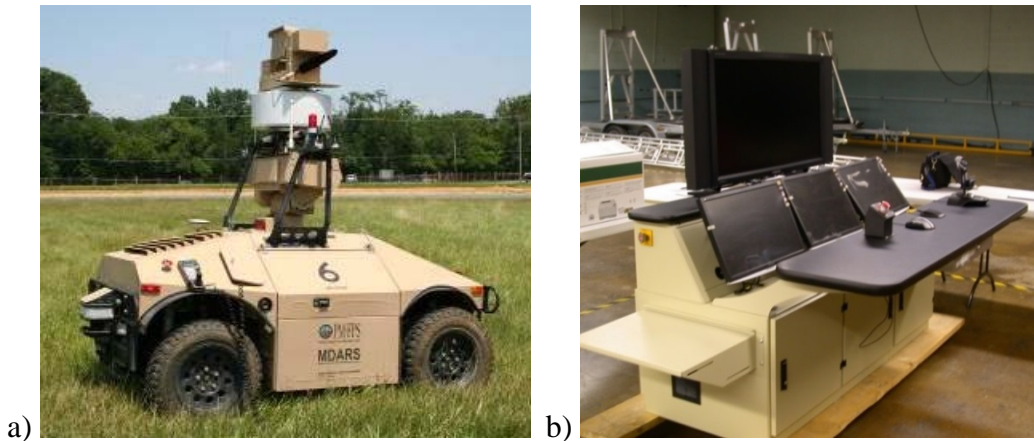

Figure 207. a) One of five *MDARS-Exterior* production vehicles undergoes final checkout at GDRS prior to delivery to HWAD, circa 2009. The upgraded *MRHA* operator console at HWAD, circa 2009.

In 2010, one of the *MDARS* SDD vehicles was transferred from HWAD to the Department of Energy's Nevada National Security Site (NNSS) in Nye County, NV (Figure 208a). In 2011, the Army Office of the Provost Marshal General (OPMG) determined *MDARS-E* was unaffordable, and the Center for Army Analysis (CAA) predicted a relatively small long-term return on investment. The remaining four systems under evaluation at HWAD were consequently transferred to NNSS as well (Figure 208b). By the end of that year, all five *MDARS-E* vehicles were providing around-the-clock site patrols (Davis, 2011).

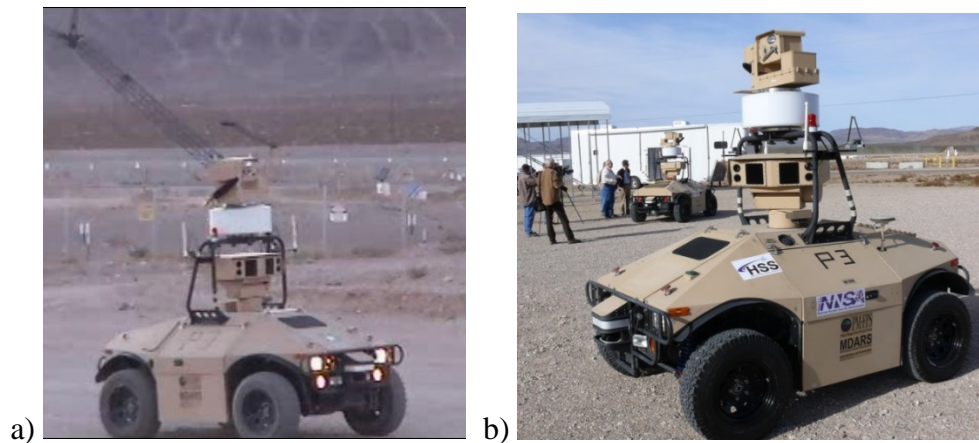

Figure 208. a) The first of five *MDARS-Exterior* vehicles is shown on patrol at the Nevada National Security Site, circa 2011. b) A film crew documents the arrival of the four additional *MDARS-Exterior* systems at NNSS.

Estimated savings at NNSS included \$1 million in annual guard-force labor and equipment-maintenance costs, plus approximately \$6 million in infrastructure costs associated with remote areas (lights, towers, cameras, motion sensors, and cable trenching/installation). Lack of spares and contractor support, however, eventually reduced the number of functional *MDARS* units to zero, and all remaining assets were subsequently placed in storage at Sandia National Laboratories in Albuquerque, NM.

In 2012, PM-FPS identified a UGV need in JUONS 0315 as a component of integrated *Entry Control Point*, and initiated modernization under *MDARS Increment II* for affordability, sustainability, and adaptability (Figure 209). See later *Combat Outpost Surveillance* and *MDARS-II* sections under Project Summaries, Volume 3.

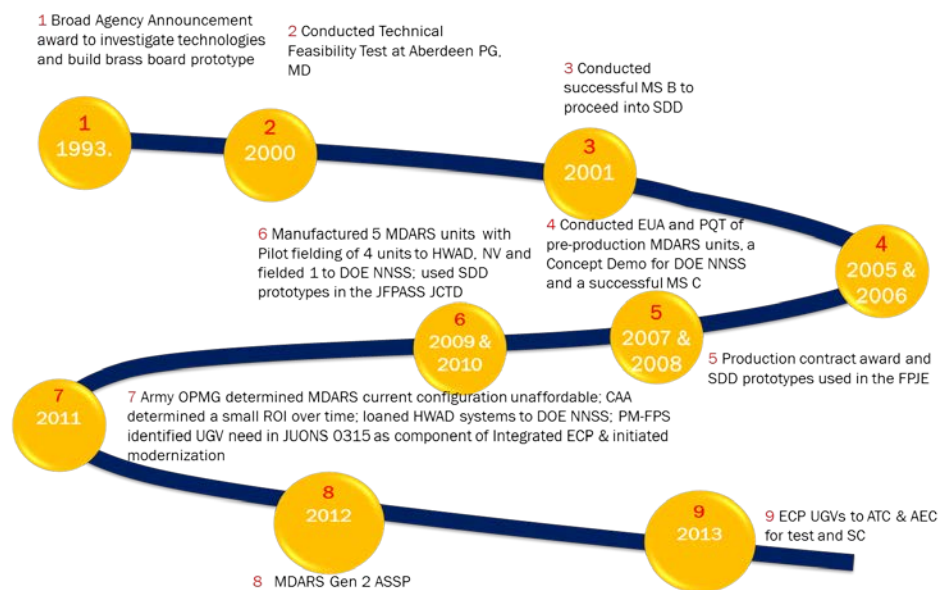

Figure 209. Production, development, and testing timeline of *MDARS-Exterior*, Generations 1 and 2.

Remote Vehicle Attitude Awareness (1990–1992)

One of the critical technology components of teleoperated UGV development is the human-machine interface, for which a key issue is the sufficient operator understanding of the remote-vehicle attitude (Pastore, 1994). Early roll-over accidents attributed to insufficient attitude cues had been observed and documented by both Sandia National Laboratories (McGovern, 1990) and NOSC (Aviles et al., 1990). While a UGV operator primarily receives remote vehicle-attitude cues from video feedback, some control stations are further equipped with a vehicle pitch-and-roll indicator. Historically, however, this type of an assistive feedback did not seem to help operators understand and react to rapidly changing vehicle attitude while traversing rough terrain (Aviles et al., 1990).

The *Remote Vehicle Attitude Awareness* project managed and executed by Tracy Heath Pastore sought to develop an improved human-machine interface that provided sufficient vehicle-attitude feedback for improved teleoperation, with minimal impact upon operator workload. A literature review was conducted of the human orientation system, specifically sensor stimulation and anatomic sensor data processing, with particular focus on reports compiled by the aviation medical community (Gillingham & Wolfe, 1986). Potential methods for presenting vehicle attitude to the operator to stimulate the human orientation system were identified and explored. The selected method involved referencing the remote visual sensors to the Earth’s gravitational field (Pastore, 1994).

When locally operating a manned vehicle, the driver collects and processes a variety of sensor inputs that collectively provide a reasonably accurate understanding of real-time vehicle orientation. When remotely driving a UGV, however, appropriate orientation cues must be recreated (or artificial cues generated) at the control console to achieve the same effect. For this effort, the human subsystems were grouped into the following categories: 1) visual, 2) proprioceptive (vestibular and non-vestibular), 3) mechanoreceptive, and 4) auditory. Methods of presenting orientation cues were identified, then classified as a stimulant of one of the three categories of human orientation subsystems as shown in Table 3 (Pastore, 1994).

Table 3. Potential methods of vehicle-attitude feedback (adapted from Pastore, 1994).

Visual Cues	Proprioceptive Cues	Auditory Cues
Stereo displays	Motion seat	Binaural hearing
Color displays	Force reflective	Warning sounds
Wide FOV displays		Alarm sounds
Gravity referenced displays		
Vehicle attitude indicator		

The actuated two-degree-of-freedom platform shown in Figure 210 was designed to gravity reference the remote color, stereo-vision, and binaural-audio sensors employed on a *HMMWV* teleoperator testbed used by the NOSC HI Lab. The existing *HMMWV* sensors were relocated to the prototype referencing platform, which was installed between the front driver and passenger seats, with the sensors at an elevation equal to the average eyes/ears height of a sitting 6-foot-tall human (Diffrient et al., 1974). The hood of the remote vehicle appeared in the video image and served as an artificial horizon indicator, providing the operator with vehicle pitch and roll information.

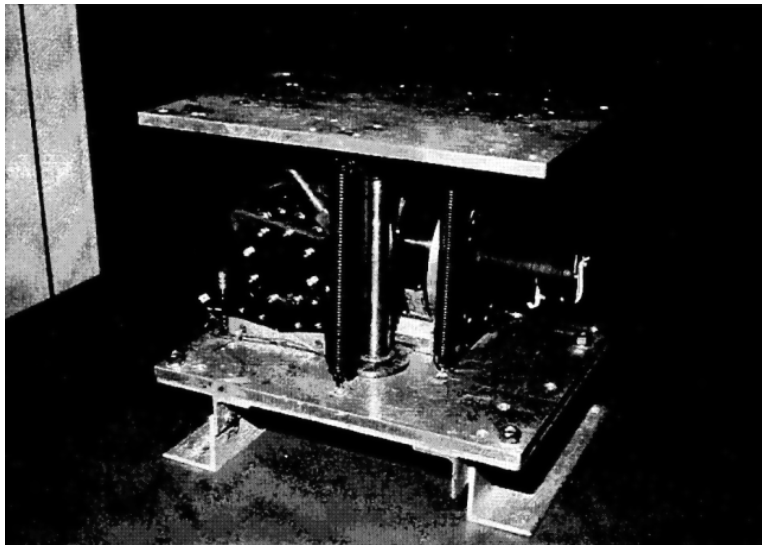

Figure 210. The electric cam actuators located under the rotating plate provided a spring-opposed linear pushing action to achieve the required angular range of motion. The referencing platform did not stabilize the remote sensors;⁴⁷ it responded only to changes in terrain slope, and not to transient bumps (adapted from Pastore, 1994).

⁴⁷ A stabilization scheme would forfeit information on road roughness.

Mechanical springs were positioned on each axis of the referencing platform to reduce the lateral motion introduced into the system by the push-rod and cam actuators. Each axis was powered by a DC motor coupled to a harmonic gear head, with limit switches to prevent rotational displacement in excess of the platform's physical limits. The system also integrated velocity data from a solid-state angular rate sensor, and had a pendulum sensor that was used to recalibrate the integrated rate sensor data every 60 seconds. A two-DOF inclinometer provided platform pitch-and-roll measurement (Figure 211).



Figure 211. Tracy Heath Pastore (left) and Dr. Jerry Fuqua (right) work on installing the gravity-referenced platform between the *HMMWV* seats (lower left) at the NOSC HI Lab. Note black 2-DOF inclinometer atop the platform.

A full-factorial experiment was conducted to compare the effectiveness of a UGV equipped with gravity-referenced sensors to the same UGV with vehicle-referenced sensors (i.e., sensors fixed to the vehicle and subject to the same motion). The control electronics were designed to accept voltage inputs from two angular-position sensors or from two hand-turned potentiometers; each axis had a select switch for the input source (Pastore, 1994). This configuration provided for efficient switching between gravity- and vehicle-referencing methods, and facilitated rapid field calibration. The test subject's error in estimating pitch and roll angles was the parameter used to compare the effectiveness of the two methods.

The test scenario was designed to emulate a typical remote-vehicle driving scenario in an unstructured environment, which is a dynamic situation requiring on-the-fly operator response, particularly if the vehicle is traversing rough unfamiliar terrain. The operator must be fully aware of vehicle attitude at all times to determine if continued operation is safe. For cost and safety reasons, the experiment was conducted in the laboratory using field-collected data. The *HMMWV* was taken to Bellows Air Force Station in Waimanalo, HI, and driven over rough dirt roads and *HMMWV*-blazed terrain at a speed of 7 ± 3 mph, alternating between gravity-referencing the sensors and vehicle-referencing the sensors.

Figure 212 shows the data-collection instrumentation. Stereo video was recorded on Recorder 1 via a field-sequential mixer, monocular video was recorded directly on Recorder 2, while binaural audio was recorded on the audio tracks of Recorder 1. The voltage signals representing vehicle pitch and roll were converted to corresponding frequencies, then recorded on the two audio tracks of Recorder 2. A clapboard was used at the beginning of each clip so that the video signals on Recorder 1 and Recorder 2 could be synchronized during editing. The data were edited into clips and

transferred to two optical disks, one for gravity-referenced and the other for vehicle-referenced data. The optical-disk medium was chosen to enable the random selection and playback of the clips during testing.

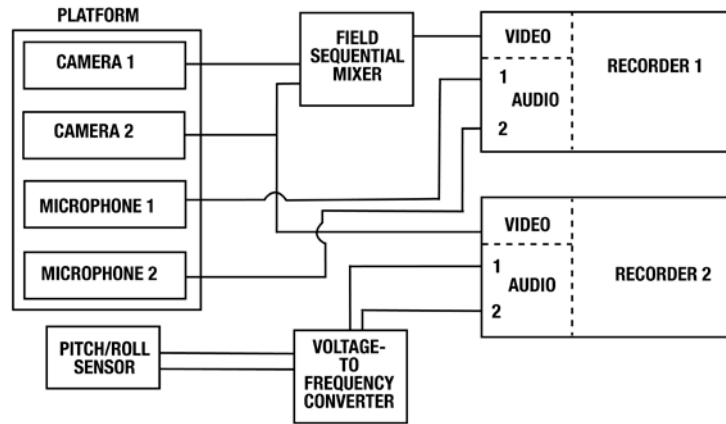

Figure 212. Field data-collection instrumentation (adapted from Pastore, 1994).

Each test subject participated in two practice sessions followed by two 20-minute test sessions. Each of these test sessions (as well as the practice sessions) featured a different method (gravity- or vehicle-referencing) of presenting UGV attitude information via video displays and audio headphones. Each session consisted of 14 driving scenarios, 45 seconds in length. At three random points during each 45-second scenario, the video and audio stopped and the test subject made an estimate of the current *HMMWV* pitch and roll angles. The test subject expressed his or her estimates by positioning a gimbaled model vehicle (see Figure 4-2) in the same spatial orientation as the observed *HMMWV*.

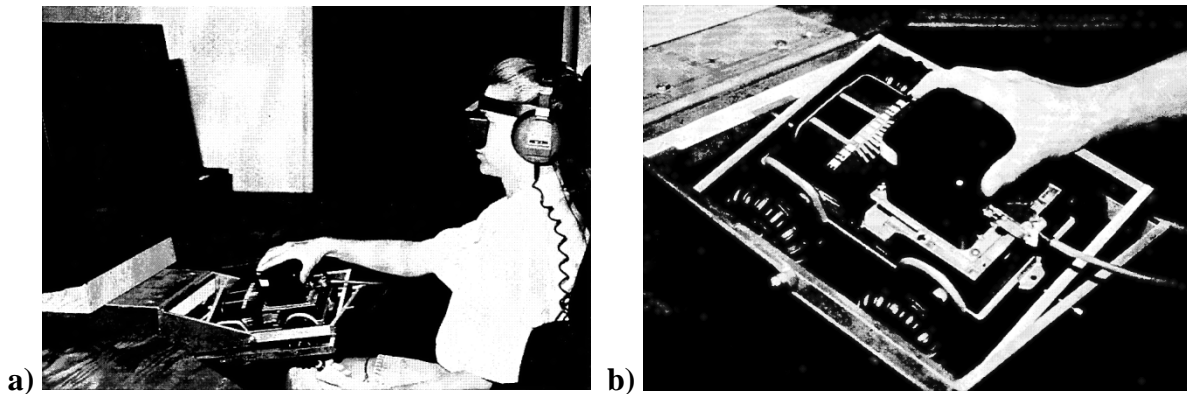

Figure 213. a) Project engineer Tracy Heath Pastore is wearing stereo flicker glasses and headphones while seated at the test operator station, with the video monitor at far left. b) Close up of the gimbaled model vehicle used to input operator's estimates of pitch and roll angles, based on the video playback (images adapted from Pastore, 1994).

The test subject was seated at the appropriate distance behind a 21-inch color monitor to match the 39-degree horizontal field-of-view of the video cameras, wearing flicker glasses for field-sequential stereo viewing, and stereo headphones for binaural hearing (Figure 213a). The gravity-referenced driving clips were stored on one optical disk and the vehicle-referenced clips were stored on another.

The clips were called up and presented to the test subject in a random but continuous fashion. The subject positioned the model-vehicle input device (Figure 213b), then depressed a hand-held switch to record its pitch and roll. Actual vehicle pitch and roll data were extracted from the audio tracks, converted from frequency to corresponding voltage values, which were then stored in an input data file. Test instrumentation is diagramed in Figure 214.

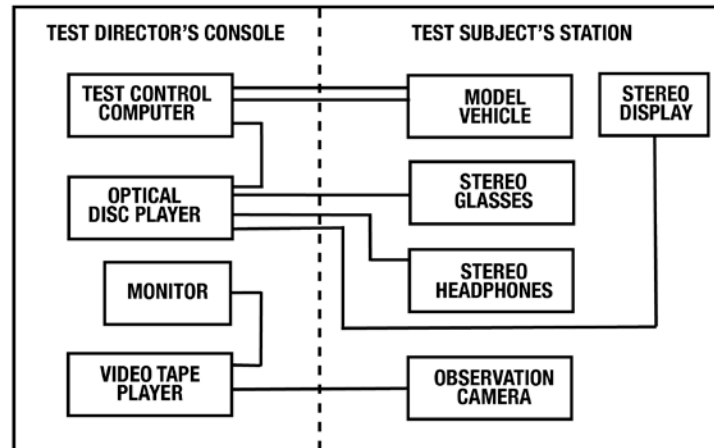

Figure 214. The prerecorded field video was presented to the test subject's stereo display by the optical disk player, and the corresponding perceived vehicle pose was captured by the model-vehicle operator-input device and recorded by the test control computer (adapted from Pastore, 1994).

Twelve volunteer test subjects were recruited from NOSC employees and the University of Hawaii at Manoa, none of whom were familiar with the effort (Table 4). Each test subject generated 42 angle-estimation data points during each of two test sessions, for a total sample size of 1008 data points. As stated earlier, the test subject's error in estimating the pitch and roll angles was the parameter used to compare the two video-referencing techniques. Methods of statistical inference were employed to show that the variance in the angle-estimation errors was attributable to the referencing method and not just random (chance) variation (Huntsberger, 1967; Miller & Freund, 1977). It was clear that the gravity-referencing method was facilitating more accurate roll estimations than the vehicle-referencing method.

Table 4. Test operator characteristics summary (adapted from Pastore, 1994).

Test Subject ID	Current Occupation	Number Years Driving	Motion Sickness Susceptibility	Previous <i>HMMWV</i> Experience	Off-road Driving Experience
1	Student	8	Moderate	Observer	None
2	Admin Assistant	8	Moderate	Observer	None
3	Engineer	18	Moderate	Driver	Minimal
4	Engineer	30	Moderate	Driver	Minimal
5	Engineer	14	Moderate	Driver	Minimal
6	Engineer	29	Minimal	Observer	Substantial
7	Engineer	12	Minimal	Observer	Minimal
8	Admin Assistant	21	High	Observer	Minimal
9	Financial Specialist	16	Minimal	Observer	None
10	Computer Scientist	14	Minimal	Observer	Moderate
11	Mechanical Technician	40	None	Driver	None
12	Student	19	Minimal	Observer	None

Although operator awareness of vehicle attitude is always important, it becomes critical when the vehicle is traversing side slopes of significant angle, and thus more susceptible to rollover. Figure 215 displays cell mean (average estimation error for each actual angle) estimation errors plotted against the actual roll angle. The estimation errors associated with gravity referencing fall within a narrow band across the entire side slope range, are consistent, and do not correspond to actual side slope angles. On the other hand, the estimation errors involved with vehicle referencing increase dramatically as the actual side-slope angle increases, becoming nearly as large as the actual side-slope angles.

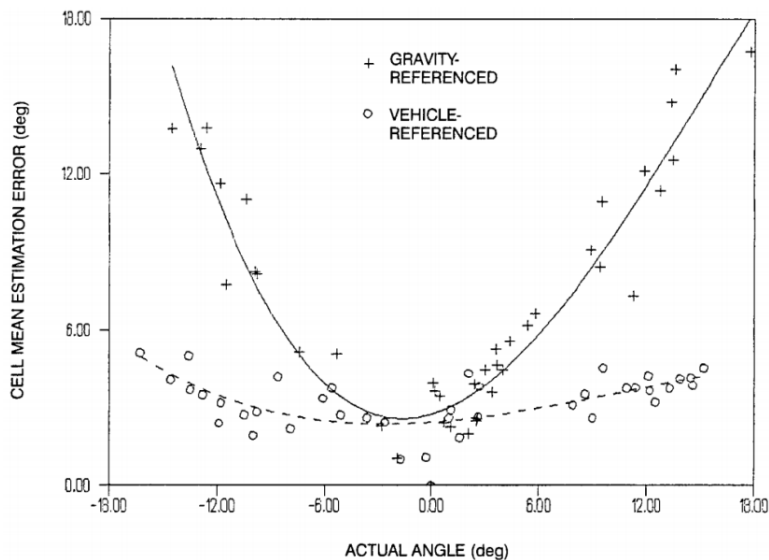

Figure 215. Plot of roll-angle cell mean estimation errors versus actual roll angles (adapted from Pastore, 1994).

In summary, statistically significant improvement (with a 99.9 percent confidence level) was observed in test operator understanding of remote-vehicle attitude, both pitch and roll, when the sensor package was gravity-referenced as compared to when it was vehicle-referenced. The

improvement in operator understanding of the vehicle roll angle with gravity-referenced sensors was greater than that observed for the pitch angle. Experimental results also showed a significantly higher level of operator confidence in vehicle attitude awareness with the gravity-referencing method. A minimal increase in operator workload, however, was also documented for the gravity-referencing method.

Mission Payload Prototype (1992–1994)

See later *Multipurpose Security and Surveillance Mission Platform (MSSMP)* project summary.

Air-Mobile Ground Security and Surveillance System (1992–1996)

In the early 1990s, a perceived situational-awareness disconnect existed between the capabilities of UAV-borne and UGV-borne remote-sensor systems employed in reconnaissance, surveillance and target acquisition (RSTA) missions (Murphy et al., 1997). The energy required by a UAV to stay aloft limited the amount of time it could loiter on station (hours), while a UGV could remain on station for a much longer period (days), but was limited in speed and movement over rough terrain. An air-mobile surveillance system with vertical-takeoff-and-landing (VTOL) characteristics conceivably combined the advantages of both options to achieve rapid deployment of remote sensors to nearly inaccessible ground locations for extended surveillance.

To validate this concept, the *Air Mobile Ground Security and Surveillance System (AMGSSS)* project was initiated in 1992, the objective being to provide a rapidly deployable extended-range surveillance capability for force protection and tactical security. The program was supported by the U.S. Army Product Manager-Physical Security Equipment (PM-PSE) and the Office of the Undersecretary of Defense (Acquisition, Tactical Systems/Land Systems). In 1996, *AMGSSS* acquired additional support from the U.S. Army Military Police School and the U.S. Army Infantry Center Dismounted Battlespace Battle Laboratory, and was renamed the *Multipurpose Security and Surveillance Mission Platform (MSSMP)*. Details of both efforts are discussed in the next section.

Multipurpose Security and Surveillance Mission Platform (1996–1997)

The *AMGSSS/MSSMP* objective was to provide a rapidly deployable extended-range perch-and-stare surveillance capability for a variety of missions (Murphy & Bott, 1995; Nguyen et al., 1996; Murphy et al., 1996):

- Force protection and tactical security
- Counter-drug and Border Patrol operations
- Detection and assessment of defensive works (minefields, tank traps)
- Remote assessment of contaminated areas (chemical, biological, nuclear)
- RF communications relays.
- Fire control for long-range weaponry

Initial focus was on the RSTA mission requirements for force-protection and front-line ground forces, allowing field commanders to quickly extend their information gathering perimeter out to 10 kilometers. The rapidly deployable/recoverable air-mobile surveillance platform could be strategically emplaced to provide ground-level autonomous surveillance, detection, and assessment capabilities. Such timely collection of mission-essential information on enemy activity and terrain could greatly facilitate force-protection planning.

Payload mobility was provided by the 6-foot-diameter Sikorsky *Cypher*, a small ducted-fan VTOL UAV weighing some 300 pounds (Figure 216). The conceptual *MSSMP* system consisted of three air-mobile ground-sensor units, a *HMMWV*-mounted base station, and a trailer for ground transport.

The air-mobile platforms could be collectively deployed as a barrier or independently assigned to monitor specific assets, critical routes, or choke points, providing long-term surveillance without putting personnel at risk. Their rapid mobility and insensitivity to intervening terrain allowed quick relocation as needed in response to changing battlefield conditions.



Figure 216. The gasoline-powered Sikorsky *Cypher* ducted-fan UAV, 6 feet in diameter and weighing some 300 pounds, was selected as the best commercially available VTOL platform for near-term *MSSMP* demonstrations.

The portable *Mission Payload Package (MPP)* shown in Figure 217 was developed for the *MSSMP* project by Center engineers and scientists (Murphy et al., 1997). Mounted on a Transitions Research Corporation pan-and-tilt unit, each surveillance-sensor package included: 1) a visible-light video camera; 2) an infrared video camera; 3) a laser rangefinder; and, 4) an optional acoustic sensor. Communication with the remote operator control unit was over the standard-issue *SINCGARS* radio shown at image lower right.⁴⁸ Multiple remote-surveillance systems (air-mobile or standalone), linked over legacy low-bandwidth tactical radio links, were to be supervised by a single operator, eliminating the need for full time attention to platform operation.

⁴⁸ *SINCGARS* was the Army's projected least common denominator *Combat Net Radio* (Murphy et al., 1997).



Figure 217. The ground-based *MPP* sensor package included both visible-light and infrared video cameras, a laser rangefinder, and an optional acoustic sensor collectively mounted on a commercially available pan-and-tilt unit.

The payload-weight and power-supply capacities of the air vehicle, along with the bandwidth limitations of the *SINCGARS* communications link, imposed several constraints on the surveillance system design:

- The sensor package had to be small, lightweight, and low power.
- The majority of sensor-data processing had to be performed at the vehicle end to reduce bandwidth and RF power required to transmit the information.
- The system architecture had to be flexible enough to allow future integration of more advanced sensors.

For prototyping purposes, a portable *Mission Payload Prototype* consisting of the sensors and remote processors was assembled, with a *Windows*-based graphical program for the laptop computer OCU (Nguyen et al., 1996). This approach allowed system development to proceed independently of the *Cypher's* progress. Demonstrations of the remote sensing subsystem were conducted with the *MPP* acting as a surrogate *MSSMP* vehicle, providing the security and surveillance functionality without the mobility. The sensors and processors were later duplicated and packaged into a *Cypher*-mounted pod (Figure 218). The *MPP* proved so valuable during field tests that it continued to play a role in subsequent system demonstrations, serving as a second air-mobile unit, a UGV-mounted unit, or a man-portable sensor package.

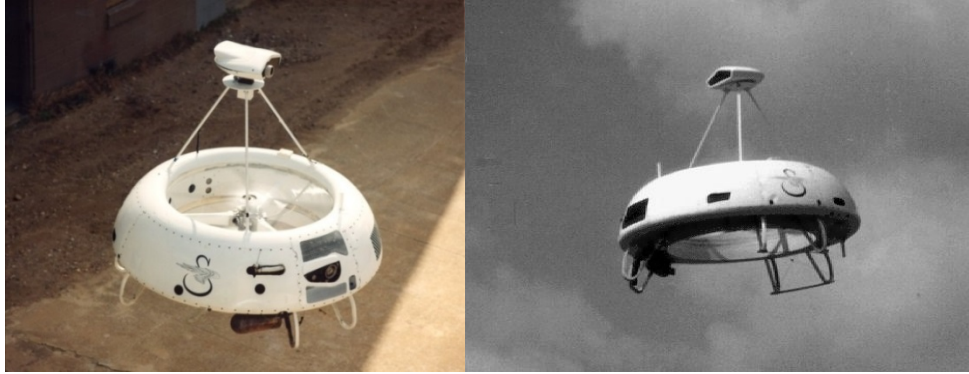

Figure 218. The sensors and processors employed on the *MPP* shown in Figure 217 were adapted for incorporation into an airborne surveillance pod mounted atop the Sikorski *Cypher* UAV.

The sensor suite included a Cohu visible light video camera with a Canon 10:1 zoom lens and 2X range extender, an Inframetrics *InfraCam* FLIR with a 100-millimeter lens, a Reigl *Lasertape* rangefinder,⁴⁹ and an interface for an optional acoustic sensor (Murphy et al., 1996; 1997). Due to the limited RF bandwidth, most sensor processing was performed by the payload, as for example acoustic and visual motion detection used to detect, identify, and locate targets of interest. Preprogrammed responses upon detection included an alert to the operator, automatic transfer of a static image, streaming video, and/or perceived range to target.

The prototype operator control unit was a laptop computer running a graphical *Windows* program (Figure 219). Commands to the remote sensors were initiated using the built-in keyboard and pointing device, while data and images sent back were displayed on the laptop's color monitor. Communication between all remote payload subsystems and the control/display station employed a fully connected Ethernet *TCP/IP* radio network with auto-relaying capability. Given the low-bandwidth nature of the *SINCGARS* radios, the real-time transmission of high-resolution data streams typically required for 360-degree remote surveillance was not technically feasible.

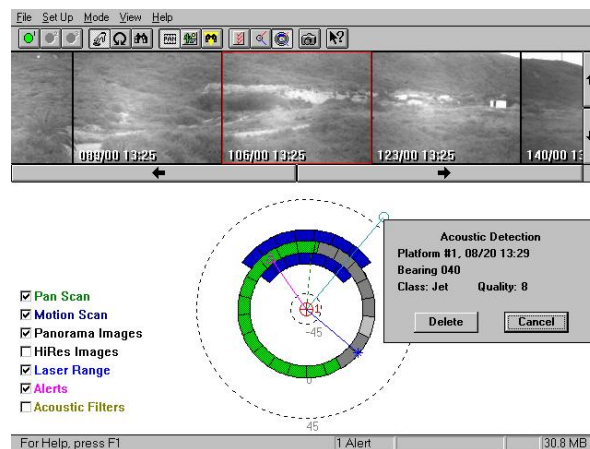

Figure 219. The *MSSMP* user interface developed by Hoa Nguyen created a mosaic of imagery that allowed the operator to virtually pan and tilt in intuitive fashion. Other modes allowed certain high-interest sectors only to be continuously updated while the remainder remained static.

⁴⁹ Good to about 800 meters, the Reigl *Lasertape* was a low-cost rangefinder surrogate for demonstration purposes.

Instead, an innovative step-and-stare technique was employed to reposition the camera through consecutive segments in both pan and tilt, during each of which a single frame of time-stamped video was captured, digitized, and transmitted back to the OCU. Referring again to the top of the display in Figure 219, this stream of images was recombined into a mosaic that allowed the operator to virtually pan-and-tilt in real time, even though the actual images being viewed may have been several seconds old. This minor latency was operationally tolerable for remote surveillance, however, especially since the operator could select a continuous feed of any specific view, while platform-executed motion-detection algorithms monitored the remainder.

In May 1996, the *MSSMP* system was successfully demonstrated in a simulated counter-drug operation at the Military Police School, Fort McClellan, AL. The man-portable sensor package (mounted on a *HMMWV* vehicle-of-opportunity) and the *Cypher*-mounted sensor package (Figure 220) simultaneously operated over the same radio network (Murphy et al., 1997). GPS waypoints programmed into the OCU prior to the beginning of a mission were used by the Sikorski *Cypher* autopilot to navigate from take-off to landing. In approximately 1 hour, Sikorski successfully taught an untrained soldier to program and fly an actual mission, using a simulator that allowed operators to plan and load waypoints, then exercise in simulation.

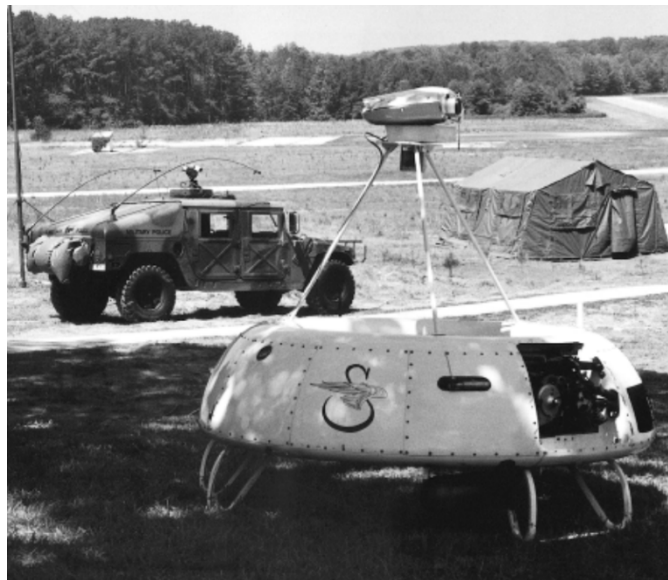

Figure 220. The *MSSMP* system demonstrated in May 1996 at Fort McClellan, AL, consisted of a *Cypher*-mounted sensor suite (foreground) and an *MPP* attached to the top of a *HMMWV* (background left).

A total of 18 flights were conducted, during which various mission payloads were used on both the air-mobile unit and the *HMMWV*-mounted *MPP*, to include both visible and infrared (FLIR) video cameras, a laser rangefinder, a smoke/gas dispersion system, a laser rangefinder/ target designator. Specialized mechanisms were used to carry and emplace small equipment, such as a communications relay or tactical security sensors. It took an average of just 10 minutes to change the vehicle payload using a standard socket set and wrenches. Due to the payload-weight limitation of the *Cypher* vehicle, however, the FLIR and laser rangefinder could not be carried on board, but were employed on the *MPP* (see again Figure 220).

In January 1997, the *MSSMP* system was showcased in a Military Operations in Urban Terrain (MOUT) scenario at the Dismounted Battlespace Battle Laboratory, Fort Benning, GA. Tactical

reconnaissance support was demonstrated with the Sikorski *Cypher* flying down streets and looking into windows to provide forward reconnaissance for advancing troops (Figure 221a), then performing fixed-site surveillance after landing on the roof of a three-story building. The air vehicle also dropped a simulated radio relay on top of a two-story building (Figure 221b) and a miniature intrusion-detection sensor in an open field (Murphy et al., 1997).



Figure 221. a) The air-mobile *MSSMP* vehicle flew just ahead of advancing troops, providing forward reconnaissance during the January 1997 demonstrations at the Fort Benning MOUT site. b) The Sikorski *Cypher* dropped a simulated communications relay on the roof of a two-story building.

Sensor Motor Transformation (1993–1997)

The ability to detect and respond to targets or obstacles, both moving and stationary, is critical for unmanned vehicle applications. While this capability is readily achieved by most animate systems, in the early 1990s it was still fairly difficult to implement on their artificial analogs. The *Sensor-Motor Transformation* project attempted to show that efficient extensible solutions to the target acquisition and discrimination problem could be achieved by emulating the mechanisms employed by biological systems. In nature, visual motion provides the basis for visual target detection, acquisition, tracking, and pursuit (Blackburn & Nguyen, 1994a).

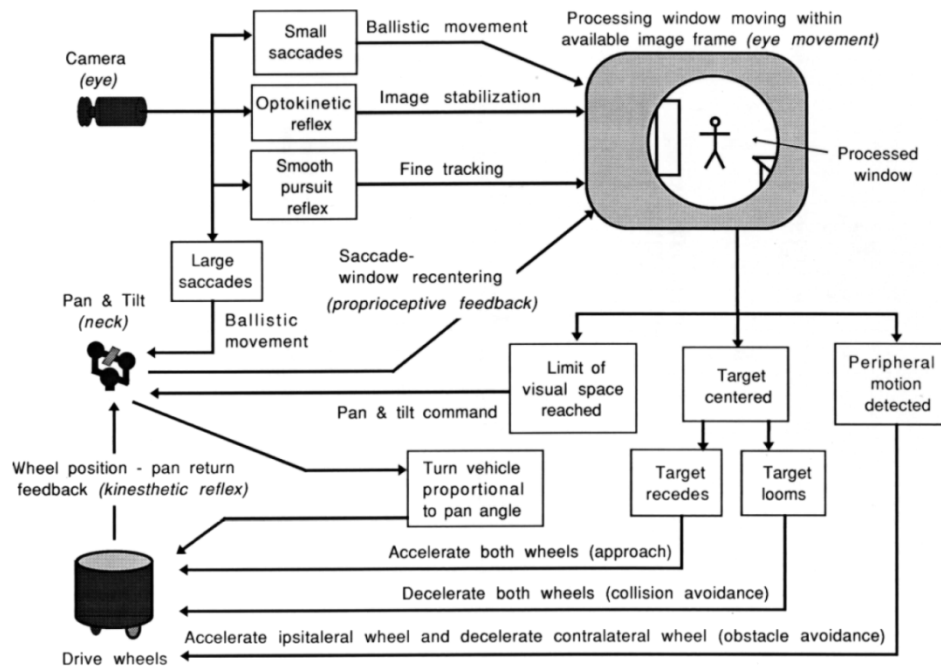

Figure 222. Visual-motor functions and relationships as applied to the *ModBot* track-and-follow behavior illustrated in Figure 223a (adapted from Blackburn & Nguyen, 1995).

For this reason, our pursued approach emulated natural strategies (Figure 222), identifying the 3D spatial location of a unique source of motion from the optic flow created by an independently moving object in the visual field (Blackburn & Nguyen, 1995). The previously discussed *ModBot* system, which had a monocular video camera on a pan-and-tilt mechanism (Figure 223), served as the software-development platform for the biologically based visual-motor control algorithms. The primary target information of interest was detected video motion, and because such could arise from either target or platform movement, an effective method of motion segmentation was required.



Figure 223. A laser pointer was added to the camera pan-and-tilt unit of the *ModBot* by Hoa Nguyen. This configuration was eventually replaced by the stereo *Zebra Vergence* system offered by Transitions Research Corporation (TRC), Danbury, CN, shown later in Figure 225.

The motion-analysis algorithms, developed under earlier work by Blackburn et al. (1987), were enhanced for this effort to allow separation of unique target motion from the collateral optic flow due to robot movement through a visually complex environment. By way of example, center-surround receptive fields were used to minimize optic flow created by the moving robot and enhance that of target motion. Testing was performed in a large room with an open work area of 32 by 18 feet (Figure 223). From a resting start position, the *ModBot* turned and moved forward in pursuit of a human walking into its visual space, with obstacle avoidance disabled to allow the robot to approach the cluttered desk.⁵⁰



Figure 224. Specifically configured for the *Sensor-Motor Transformation* project, the visually guided *ModBot* autonomously trails electrical engineer Theresa Tran as she moves about in Room 115 of Building 622 (adapted from Blackburn & Nguyen, 1994a).

Challenges associated with this application included the following (Blackburn & Nguyen, 1994a):

1. The complexity of the background
2. The proximity of the target
3. The velocity of the target image on the visual field
4. The absence of unique distinguishing features associated with the target
5. The limitations of on-board processing power and energy resources

The underlying strategy was explained by Blackburn & Nguyen (1995):

“Natural mechanisms have been successful at all levels of complexity, and they achieved additional complexity and capability by maintaining and modulating more elementary functions. Since nature began with the production of very simple organisms living successfully within protected ecologies, so might we begin in our design of artificial intelligence machines with very simple functions appropriate for a particular environment.”

⁵⁰ With obstacle avoidance enabled, the robot tended to approach the target more cautiously, until a sufficiently clear approach path was perceived (Blackburn & Nguyen, 1994a).

In 1994, the machine-vision system shown in Figure 223 was upgraded to a stereo pan, tilt and vergence mechanism developed by *TRC* (Figure 225), which was used to control both the *ModBot* and a five degree-of-freedom stationary manipulator arm. These two efforts combined vision, navigation, and manipulation to study learning of cross-modal sensor-sensor and sensor-motor sequences (Blackburn & Nguyen, 1994). Performance of the vergence mechanism was rather disappointing, however, and consequently did not add much to the perception functionality (Nguyen, 2016).

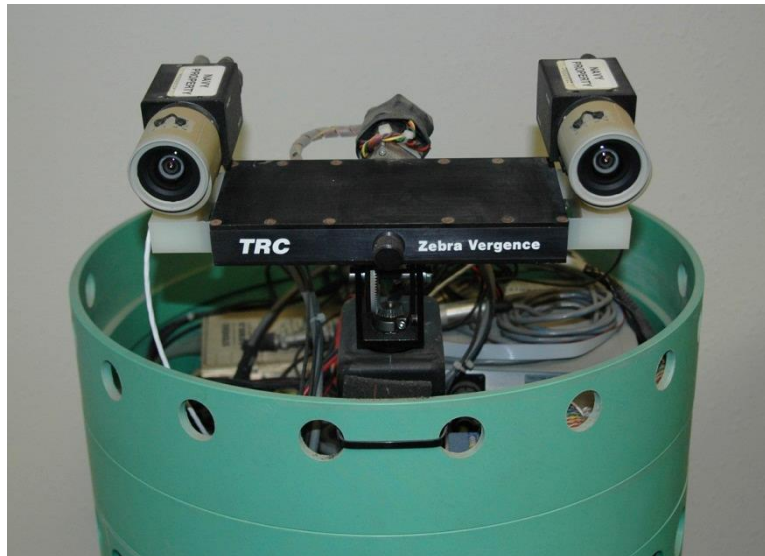

Figure 225. The TRC *Zebra Vergence* stereo pan, tilt, and vergence unit was temporarily mounted on the top ring of the *ModBot* to support the *Sensor-Motor Transformation* project.

The *Sensor-Motor Transformation* approach emulated natural strategies, identifying the 3D spatial location of a unique source of motion from the optic flow created by an independently moving object in the visual field (Blackburn & Nguyen, 1995). The algorithms of active perception employed both reflexive and adaptive mechanisms (Blackburn & Nguyen, 1994). Reflexive mechanisms provided low-level fault-tolerant solutions for target detection, segmentation, and obstacle avoidance, while adaptive mechanisms provided intrinsically modifiable solutions to difficult problems such as eye-hand calibration and target discrimination.

Man-Portable Networked Sensor Package (1997–1999)

Spawned by the *MSSMP* project in the latter half of 1997, the *Man-Portable Networked Sensor Package (MPNSS)* effort focused on development of ruggedized lightweight sensor system for unattended battlefield applications. Experience gained at the Ft. Benning MOUT-site demonstrations earlier that year suggested that by using the *MSSMP* wireless-network architecture, but without the cost of the air-mobile platforms, a network of inexpensive man-portable sensor units could make significant contributions to military operations in urban terrain. An artist's concept drawing is shown in Figure 226.

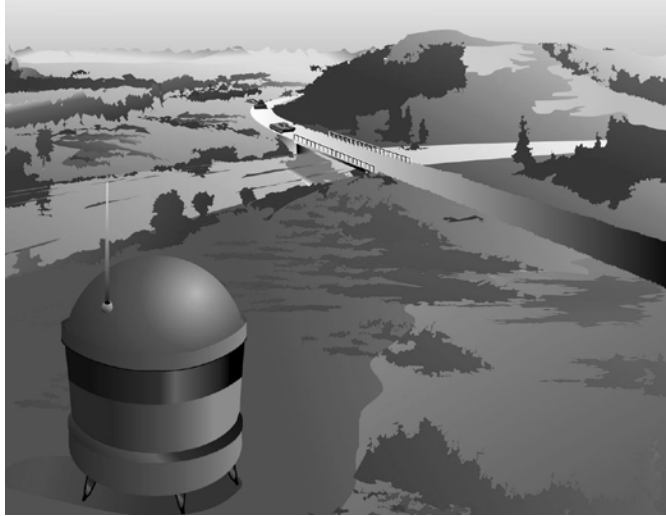

Figure 226. Artist's concept of a ruggedized *Man-Portable Networked Sensor Package* for unattended battlefield applications (adapted from Bryan, Nguyen, & Gage, 1998).

The resulting *MPNSS* system consisted of a scalable suite of smart sensors configured into man-portable packages that could be distributed throughout a surveillance area, linked by a wireless-network communications architecture. The majority of data processing was performed at the remote sensor node, with control/output data to and from the nodes available to users throughout the network. This remote-processing approach reduced the bandwidth and power consumption required to transmit the information, as decisions made by the remote computers ensured only useful data was transmitted. The flexible system architecture enabled scalability, in that a given sensor or network of sensors could easily be configured to satisfy specific mission requirements.

By way of example, sensor packages could consist of a helmet-mounted video camera, an unattended ground sensor, or a suite of integrated sensors. The baseline sensor suite shown in Figure 227a provided the following functionality:

- Video/images for visual target classification
- Video motion detection
- Image enhancement
- Acoustic alerts and acoustic classification
- Sensor/image processing for bandwidth reduction
- GPS, heading, and range data processing for absolute target positioning

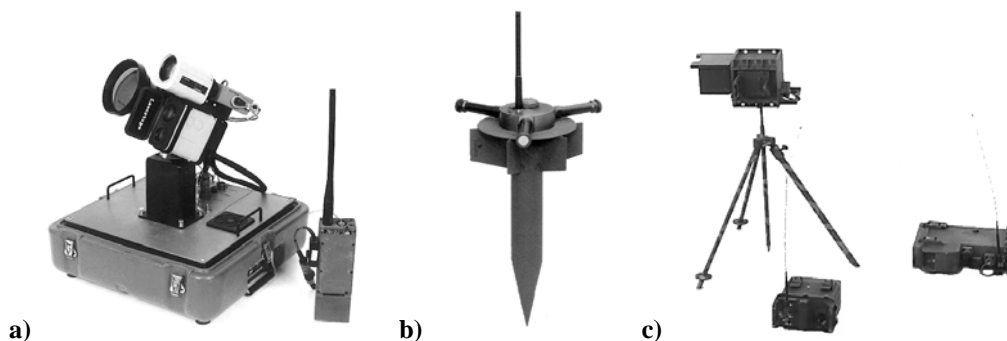

Figure 227. Tested *MPNSS* sensors included: a) Integrated *MPNSS* sensor package; b) Northrop Grumman's *Unattended Ground Sensor*; c) *Tactical Remote Sensor System (TRSS)* ground sensor.

Given the evolving state of commercial acoustic detectors, an external data connection was provided for an optional acoustic sensor, instead of physically incorporating one into the *MPNSS*. In late 1995, a prototype air-deployed acoustic sensor made by Northrop-Grumman, a small ring of three microphones with custom processing hardware and a serial interface (Figure 227b), had been connected to the *MSSMP Mission Payload Prototype* and tested in the field. Output included target azimuth, target type (ground vehicle, jet, helicopter, etc.), and detection/classification confidence. Subsequent *MPNSS* software provided programmable filters that allowed the user to discard certain types of sound from specified azimuthal areas.

Legacy sensor systems such as the *Tactical Remote Sensor System (TRSS)* shown in Figure 227c, the *Improved Remotely Monitored Battlefield Sensor System (IREMBASS)*, and the *Tactical Automated Security System (TASS)* employed a standard communications protocol (*SEIWG-05*) for transmitting sensor data over VHF point-to-point radio links. A small VHF transceiver was embedded in the baseline *MPNSS* sensor package to deliver this data to the payload processor, with associated software to monitor alerts from these sensor systems and reformat the data into IP packets. This data was multiplexed and distributed across the network to all users.⁵¹

Three low-power *PC/104* microcomputers, interconnected via Ethernet link, processed and reduced the raw data collected before passing to the control/display unit. Each computer had its own Internet address, and theoretically could be thousands of miles away, connected by any available IP-based infrastructure, wired or wireless. This distributed architecture allowed parallel development of the various subsystems at different sites, facilitated debugging by substitution of any processor by an equivalent desktop computer, and resulted in a flexible system that could be readily expanded or modified (Nguyen et al., 1996).

The payload processor communicated with the control/display, interpreting and executing high-level operator inputs to generate low-level commands to the various sensor subsystems. It also coordinated the flow of information between all payload computers, monitoring, filtering, and consolidating alerts from the image processor, acoustic detector, and legacy sensor gateway. The Image Processor performed video motion detection and image enhancement when commanded, compressing still images before sending them to the control/display. The video processor was dedicated to real-time video compression and transmission, using a *Windows-95 CUSeeMe* software package

The *MPNSS* communications architecture consisted of an all-digital adaptive network providing integrated video, voice, and data services as shown in Figure 228 (Murphy et al., 1997; Martin & Bryan, 1995). The physical layer for IP-based network connectivity was provided by Magnavox/SAIC PCMCIA *Tactical Communication Interface Modules (TCIMs)*, with software modified by us, over *SINCGARS* radios. Beyond-line-of-sight network connectivity was established with this tactical IP data link during operational field tests in 1995. As effective data throughput was low (< 500 bps), commercial WLAN technology was substituted to improve system performance until military communications technology had further advanced.

⁵¹ A more detailed description of *MPNSS* sensors is provided in Murphy et al., 1996.

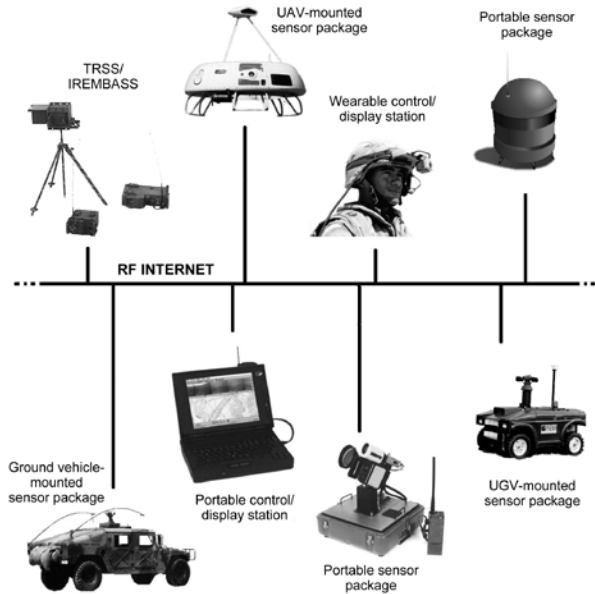

Figure 228. The scalable *MPNSS* system architecture allowed for optimal tailored solutions to varying user needs.

The *MPNSS* user interface shown in Figure 229 was a *Windows*-based software program with standard windows, menus, buttons, and dialog boxes supporting the following functionalities:

- Command remote sensors to perform elementary functions, including taking target snapshots (at specified zoom, focus, gain, polarity, azimuth and elevation, etc.)
- Determine target position and measure target range
- Enhance target images prior to transmission
- Initiate live compressed video of target
- Program complex sequences of commands, such as composing image panoramas, acoustic filters, and motion detection at various critical scene points

An in-depth discussion of how these commands are executed can be found in Murphy et al., 1996, with details of the Control/Display features presented in Nguyen et al., 1996.

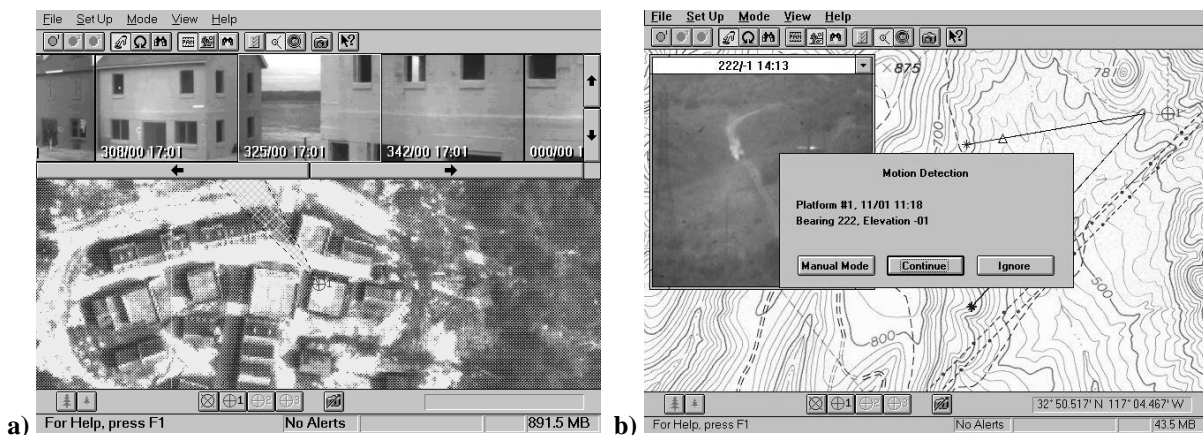

Figure 229. Sample Control/Display screens: a) Ft. Benning panorama and corresponding aerial photo; b) Motion detection alert, with target image and location overlaid on map.

The Control/Display program was initially developed for laptop computers (Figure 230a), then subsequently demonstrated on a Xybernaut soldier-wearable computer (Figure 230b), and the Litton *Handheld Terminal Unit* (Figure 230c). The wearable computer included an integrated trackball, a battery pack worn around the waist, and a small head-mounted display, with an integrated video camera, microphone and earphone. This configuration added several new capabilities to the system (Bryan, Nguyen, and Gage, 1998):

- The warfighter could access, monitor, and control remote sensor data while on the move.
- Voice control and feedback of sensor system functions provided hands-free operation.
- The heads-up display presented remote sensor data within the warfighter's field of view.
- Video from the head-mounted camera enabled the warfighter to function as a mobile sensor within the network.



Figure 230. Tested *MPNSS* control/display configurations included: a) a laptop computer, b) a wearable computer, and c) the *Dismounted Soldier System Unit*.

In January 1997, the prototype *MPNSS* baseline sensor package was demonstrated in the same wireless network with its *Cypher*-mounted counterpart in the U.S. Army MOUT facility at Fort Benning, GA (Murphy et al., 1997). The system provided reconnaissance support for advancing troops and security surveillance in urban terrain. In August 1997, the *MPNSS* portable baseline sensor package was operated in stand-alone configuration during MOUT exercises at Camp Pendleton Marine Corps Base, CA. Test plans were developed that same year to demonstrate long-term severe-weather use of *MPNSS* for augmenting base security measures at Naval Air Station Keflavik, Iceland, although such a plan was never implemented.

DARPA Tactical Mobile Robotics (1997–2003)

Initiated by Dr. Eric Krotkov in 1997, the DARPA *Tactical Mobile Robotics (TMR)* program was managed by Lieutenant Colonel John Blicht, U.S. Army Reserve (Krotkov & Blicht, 1999). Dr. Doug Gage of the Adaptive Systems Branch (D371) served as *TMR* chief engineer (Gage, 2000). The overarching goal of the program was to develop versatile, reactive, and robust teams of small robots that could operate in restricted or denied areas under a variety of realistic conditions (Anhalt & Spofford, 1999). These envisioned robotic teams were intended for use where humans could not go due to size constraints, dangerous environments, or unstable conditions.

To help achieve this goal, the *TMR* program developed a number of small man-portable robotic prototypes (Figure 231), mission payloads, and mobile user interfaces, with the following technology objectives (Anhalt & Spofford, 1999):

- Robotic team configuration and control
- Robotic collaboration

- Robust navigation, localization, and mapping
- Sensor fusion, to include sensor data from multiple viewpoints
- Target detection and tracking

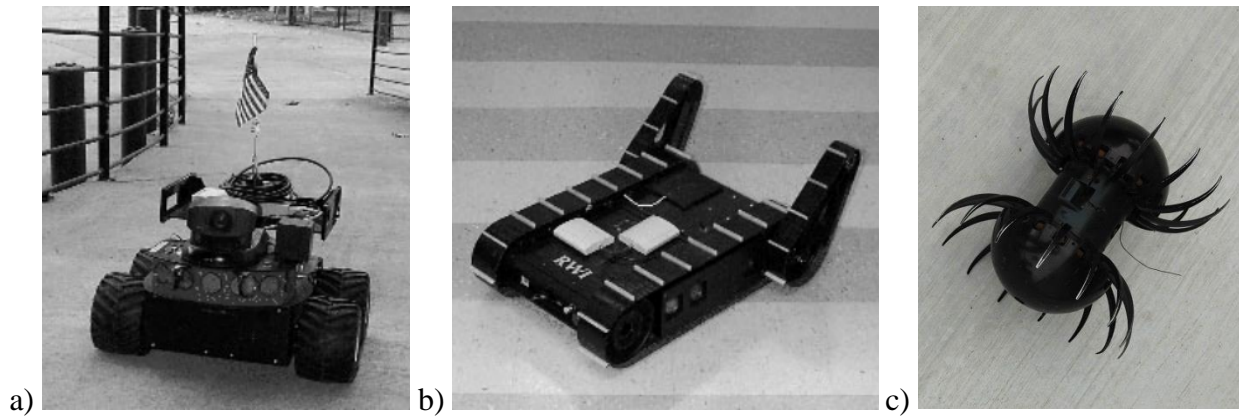

Figure 231. a) The *Pioneer AT* development surrogate from ActivMedia, Peterborough, NH. b) The teleoperated *Urbie* robot, developed by the Real World Interface (RWI) division of IS Robotics, now iRobot Corporation (images adapted from Arkin, Collins, & Endo, 1999). c) A teleoperated Draper Laboratories “ThrowBot” prototype in expanded mode.

A number of developmental challenges were identified (Gage, 2000):

- Acquiring critical component technologies to support the desired functionality
- Delivering systems small enough to fit in a rucksack but large enough to perform in challenging environments, with sufficient on-board energy for meaningful time on station
- Providing supervised autonomous navigation to reduce operator burden and control bandwidth requirements
- Performing appropriate systems integration and implementation to achieve a useful product

Core performers of Phase I (*BAA 98-08 Part A – Technology*) by focus area were (Gage, 2000):

- Mobility: Massachusetts Institute of Technology
- Sensors: University of Michigan (Figure 232)
- Perception: Yale, SRI International
- Autonomy: SRI International, Carnegie Mellon University, Stanford University, University of Southern California, and Georgia Tech
- Mission Packages: Foster-Miller



Figure 232. The University of Michigan's *FLEXnav PPE* precision dead-reckoning system implemented on a *Pioneer AT*.

An example autonomous behavior implemented by Georgia Tech on the *Pioneer AT* surrogate is shown in Figure 233, where the robot's mission was to enter and search each room in the *a priori* floorplan of Figure 234a, looking for a red-colored target object. In the first scenario, the robot started at far left in the expanded image at lower left, travelled down the hallway past Room 360, then entered the adjacent copy room, looking for its visual target. The rightmost image in Figure 233 shows the interior of the copy room immediately upon entry, and with no sign of the red object, the robot eventually stops at the blue icon depicted in Figure 234a (Arkin, Collins, & Endo, 1999).



Figure 233. The *Pioneer AT* test surrogate enters the hallway (far left), traverses past Room 360, turns towards the copy room (center), enters the copy room, and perceives the interior as devoid of the red target object (far right) (images adapted from Arkin, Collins, & Endo, 1999).

The trial was then repeated with the red target object prepositioned in the copy room. The mission was initiated from the same starting point as before as shown in Figure 234b, with the robot traversing the hallway past Room 360 and turning in towards the copy room. As shown in Figure 235, the red target object was immediately detected by the on-board *Cognachrome* vision system developed by Newton Research Labs, Renton, WA (Arkin, Collins, & Endo, 1999), causing the robot to stop prior to room entry (see again Figure 234b). If the target had not been detected, the robot would have entered the room, continuing to search, as in the previous example (Figure 233).

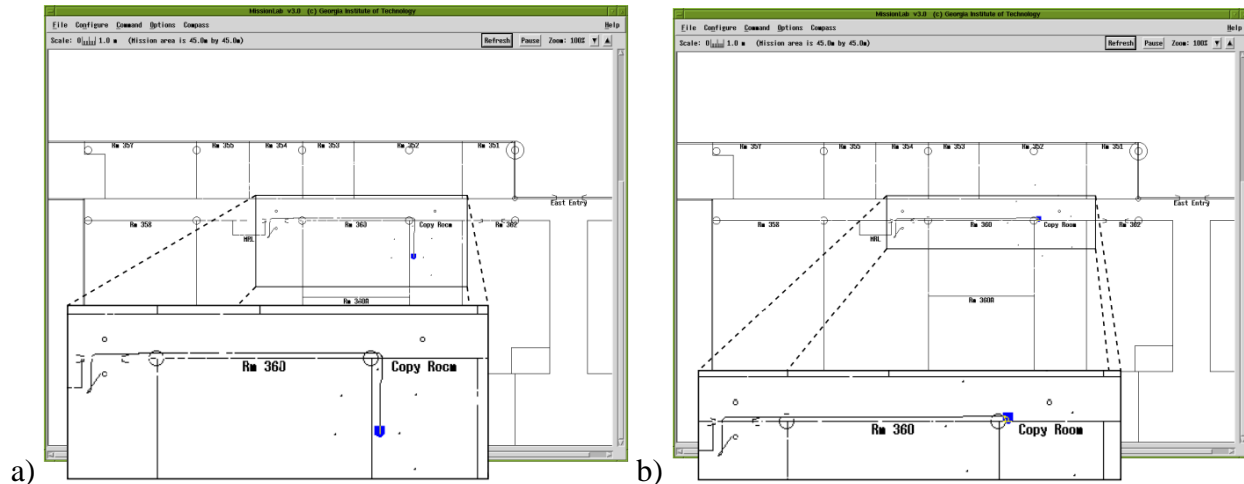

Figure 234. a) The *Pioneer AT* initiates the first remote-room-search trial at lower left, then enters the copy room at lower right after not finding the red target object. b) The robot initiates the second trial as before at lower left, but stops short of the copy room upon detecting the red target object (adapted from Arkin, Collins, & Endo, 1999).

In July and October of 1999, these preliminary test results were further validated at the Fort Sam Houston *TMR* test site in San Antonio, TX (Arkin, Collins, & Endo, 1999). In the first round of tests, the robot explored a corridor inside an abandoned hospital, looking for an open room that potentially contained a biohazard, with *a priori* knowledge of the approximate room location. In the second round, the robot had to visually detect a wall-mounted biohazard sign with no prior knowledge of its location in order to locate the room to be searched. Eight trials were run under the first scenario, out of which the robot successfully completed the mission five times, with five completions out of 12 trials for the second (Collins, Arkin, Cramer, & Endo, 2000).



Figure 235. The *Pioneer AT* test surrogate enters the hallway (far left), traverses past Room 360, turns towards the copy room (center), and comes to a halt upon detecting the target object in the copy room (far right) (images adapted from Arkin, Collins, & Endo, 1999).

The DARPA Phase I *BAA 98-08 Part B – System Design* performers included the below organizations (Gage, 2000):

- Science Applications International Corporation
- Draper Lab
- Raytheon Corporation

The following *BAA 97-20 Phase II* performers were the Jet Propulsion Lab (project lead), Carnegie Mellon University (navigation), IS Robotics (mobility), Oak Ridge National Laboratory (group behaviors), and the University of Southern California (operator control unit). The project focus by this point was to develop intelligent, autonomous navigation for small UGVs using the IS Robotics *Urbie* mobile platform (CMU, 2016a).

As summarized by Doug Gage (2000), the technical goal was:

“Development of a system of robots capable of operator tasked and monitored perception-based autonomous mobility in diverse unstructured environments that can fit in a rucksack and be employed in coordinated groups as a tool for the dismounted warfighter.”

Autonomous robotic stair climbing was viewed as a critical behavior required for reconnaissance and/or search and rescue missions in urban environments. In support of this need, the NASA Jet Propulsion Laboratory (JPL) developed two estimation and control algorithms that significantly increased the speed and effectiveness of autonomous stair climbing (Helmick et al., 2002):

- A Kalman filter that fused visual and lidar data with inertial measurements for improved vehicle-attitude estimates at a high rate
- A physics-based controller that minimized heading error and maximized effective forward velocity during stair climbing

Experimental results using the iRobot *PackBot* shown in Figure 236 validated the improved performance of this approach over previous methods (Helmick et al., 2002).

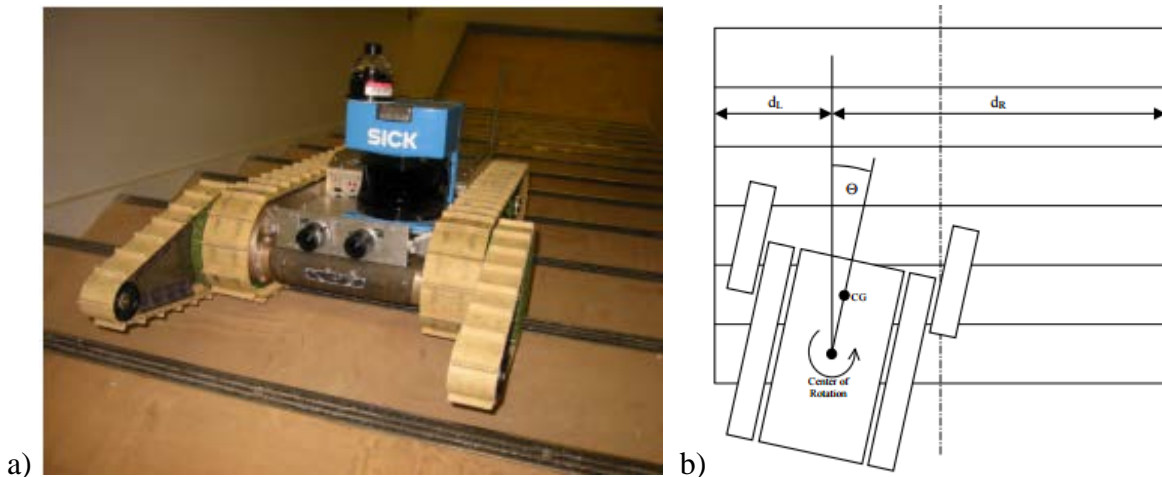

Figure 236. a) The JPL stair-climbing algorithms were evaluated on an early version of the iRobot *PackBot* outfitted with a pair of video cameras and a 2D SICK *LMS-200* lidar. b) JPL edge detection algorithms applied to single-camera video images estimated heading θ and center position d_L/d_R at approximately 4 Hz, which allowed differential steering to keep the robot on heading and centered (adapted from Helmick, Roumeliotis, McHenry, & Matthies, 2002).

Carnegie Mellon University (CMU) developed monocular visual servoing as a supervised autonomous driving mode for the *Urbie* robot, wherein the remote operator would designate an item of interest (such as a door or stairway) for the robot to approach (CMU, 2016a). By servoing on the image of the selected target, the robot could autonomously execute the driving task without human assistance (CMU, 2016b). An omnidirectional camera developed by Professor Shree Nayar at Columbia University allowed 360-degree target selection in the surrounding environment (Nayar, 1997). Technical issues included the selection of suitable visual templates to track, seamless detection and recovery in the event of loss of track, and integration with other behaviors such as obstacle avoidance (CMU, 2016a).

The ultimate *TMR* goal of implementing intelligent behaviors on the *PackBot* was unfortunately cut short by the 9/11 terrorist attack on the World Trade Center, after which Lieutenant Colonel Blich deployed to Iraq with several teleoperated program assets. As the program closed down, Bart Everett, Robin Laird, and Cliff Hudson convinced DARPA to transition relevant *TMR* contracts to the Center, and subsequently cherry picked promising autonomy technology via the *Technology Transfer* program. That same afternoon, they visited Jeff Bradel and a few members of his staff at the nearby Office of Naval Research to try and set up a similar arrangement with ONR 30. (See further *Technology Transfer* discussion under Project Summaries, Volume 2.)

Man-Portable Robotic System (1999–2012)

In 1999, under the NAVSEA-funded *Man-Portable Robotics System (MPRS)* project, SSC San Diego developed a small UGV for use by Army engineers in tunnel, sewer, cave, and urban-structure reconnaissance. A small 65-pound tracked vehicle based upon the chassis and running gear of the Foster-Miller *Tactical Adjustable Robot (TAR)*, the *URBOT (Urban Robot)* was fully invertible in that it could flip over and continue to operate. Early *URBOTs* were teleoperated from a wearable operator control unit (OCU), allowing the warfighter to drive the small vehicle into high-risk areas while receiving video feedback to assess the situation before human entry. Initial prototypes were used in several U.S. Army experiments at Fort Leonard Wood, MO, Fort Drum, NY (Figure 237a), and Fort Polk, LA (Figure 237b).



Figure 237. a) Soldiers prepare to lower an *URBOT* down a manhole at the Fort Drum Military Operations in Urban Terrain (MOUT) site with specially designed tackle that facilitated post-mission asset recovery. b) The *URBOT* is about to enter this underground culvert on a counter-IED training mission at Fort Polk, LA.

The front-mounted adjustable "snout," which housed various sensors and illuminators for situational awareness, could be tilted ± 90 degrees to look up or down. The sensor package employed both forward-looking infrared (FLIR) and low-light cameras, their composite-video outputs fused into a single image through a "fader" card. By fading between the FLIR and low-light camera, the remote operator could adjust the fusion ratio to extract the maximum amount of information from the combined video imagery. The result was presented to the operator on a small ruggedized hand-held display as shown in Figure 238.



Figure 238. Bart Everett (center) briefs DARPA Director Dr. Tony Tether (grey suit) on the Center's unmanned systems projects, as Mike Bruch (lower left) operates the *Urban Robot* (not shown) using the drive pendent (right hand) and video display (left hand) of the custom-designed back-packable controller, circa summer 2001.

Not counting the initial prototype shown in Figure 237, five second-generation *URBOTS* were ultimately constructed by the Robotic Systems Branch, the first of which is shown in Figure 239a. Additional upgrades in the form of improved electronics and heavy duty tracks supplied by Foster-Miller were made to the next four units to significantly improve reliability and performance (Figure 239b). As discussed in the remainder of this section, these rugged and reliable systems served in multiple roles over the next several years in support of continued development, user test and evaluation exercises, crisis response, and in-theater deployment.

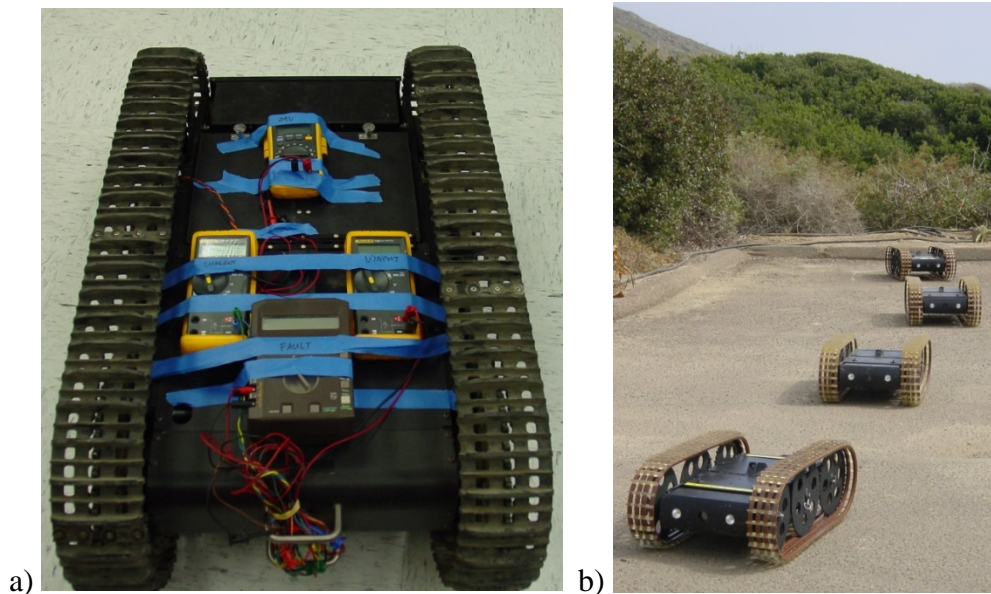

Figure 239. a) An early second-generation *URBOT* outfitted with test equipment to evaluate the performance of the drive-motor H-bridge controllers under load. b) These last four *URBOTS* were retrofitted with the much improved heavy-duty Foster-Miller tracks developed for their Talon robot.

At the request of the RS JPO, Bart Everett, Robin Laird, and Mike Bruch supported the Center for Robotic Assisted Search and Rescue (CRASAR) with three *URBOTs* to evaluate structural damage at the World Trade Center site after the terrorist attack on 11 September 2001 (Figure 240). Other robotic organizations supporting CRASAR (Foster-Miller, iRobot, and the University of South Florida) used smaller vehicles, primarily the Foster-Miller *SOLEM* and Inukton *Vari-Track*, to better penetrate the rubble pile and identify areas where victims were located (Mullens, 2001). Following this week-long evolution, attention returned to the tactical applications for which the *URBOT* was originally designed.



Figure 240. a) Robin Laird controls the Foster-Miller *Special Operations Lemming (SOLEM)* robot from its compact self-contained operator control unit. b) Mike Bruch (right) controls one of three *URBOTs* while Bart Everett looks on, with the remains of WTC Tower Two in background.

In April 2002, two *URBOTs* and two Inukton *Variable Geometry Tracked Vehicles (VGTVs)* were deployed to Afghanistan with U.S. Navy EOD forces to assist in clearing buildings and caves (Figure 241). These assets were part of the Robotic Systems Pool, funded by the OSD Joint Robotics Program and managed by SSC San Diego, as later discussed in the Project Summaries section, Volume 2 (Mullens, 2002a). The robots were used by Navy EOD personnel for the remote inspection of mines, booby traps, and what would soon become known as improvised explosive devices (IEDs).



Figure 241. Lieutenant (j.g.) Kevin Childre loads a pair each of *URBOTs* and Inukton *VGTVs* provided to EOD Mobile Unit 3 (EODMU3) by SSC San Diego for in-theater deployment on 1 April 2002.

In June that same year, Colonel Bruce Jette, U.S. Army, led a Robotic Tiger Team on a 90-day quick-response technology insertion in Afghanistan to provide commercial man-portable robots to warfighters engaged in life-threatening roles.⁵² Made up of representatives from iRobot, Exponent, University of Southern California's Institute for Creative Technologies (Figure 242), and active duty Army personnel, the goals were: 1) to improve mission capability while decreasing risk; 2) assess the full range of tactics, techniques, and procedures (TTPs) for small robots in an operational environment; and 3) examine the entire process involved in rapid integration of robotic systems (REF, 2015).



Figure 242. Ted Hromadka of Exponent (left), Tom Frost of iRobot (center), and Dave Hendrie of the USC Institute of Creative Technologies (right) en route to Afghanistan in support of the Rapid Equipping Force on 28 June 2002 (image courtesy iRobot Corporation).

⁵² The official team designation was "Rapid Integration of Robotic Systems" (REF, 2015).

Based out of Bagram Air Base, the team conducted missions in Kandahar (Figure 243), Gardez, and Kwest to mitigate combat casualties from booby traps and grenade blowback while searching and clearing caves (REF, 2015). The resulting successes led Colonel Jette to recommend to the Vice Chief of Staff that the Army continue to pursue spiral fielding of robots, and establish an equipping strike force, a supporting sustainment process, and a supporting technology mining team. The Rapid Equipping Force (REF), headquartered at Fort Belvoir, VA, was subsequently stood up under the Army G-3/5/7 in late 2002 to support warfighters in *Operation Enduring Freedom* using deployed teams of subject matter experts (REF, 2015).⁵³



Figure 243. a) An Iraqi interpreter observes an iRobot *PackBot* exiting a suspect bunker in Kandahar. b) Approximately 65 pounds, the *PackBot* could be portaged to the start of a mission, as for example exploring this cave in Afghanistan. Note the wearable *M7* Operator Control Unit (courtesy iRobot Corporation).

Also in 2002, a *Chemical, Biological, Radiological, and Nuclear (CBRN)* plug-and-play sensor payload was developed for the *URBOT* at the request of the U.S. Army Chemical School at Fort Leonard Wood, MO (Figure 244a). Towards the end of this effort, a Limited Objective Experiment (LOE) was conducted in February 2003 at SSC San Diego to test the payload and its standard-issue sensors: the *MultiRAE Plus* gas sensor, the *Joint Chemical Agent Detector*, and the *AN/UDR-13* Radiac (Figure 244b). The payload was subsequently adapted for use on the Mesa Engineering *Matilda* robot and demonstrated by Major Todd Cline of the RS JPO in Kuwait to the Combined Joint Task Force - Consequence Management.

⁵³ On 30 January 2014, the Army declared the REF an enduring capability, which was subsequently realigned under the U.S. Army Training and Doctrine Command.

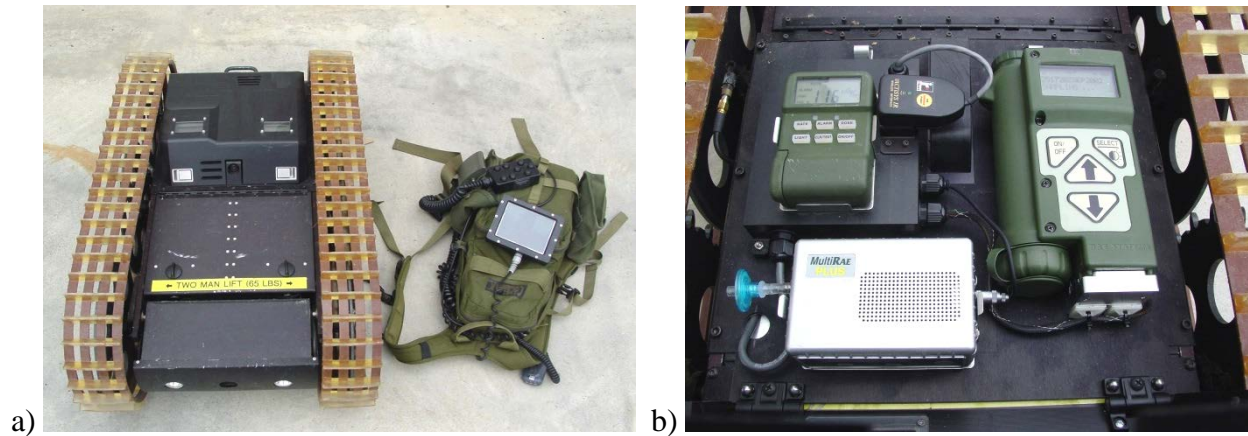

Figure 244. a) The prototype chemical sensor payload is shown here on the *URBOT*, circa 2002. b) Interior view of the sensor payload showing the *MultiRAE Plus* gas sensor (bottom left), the *AN/UDR-13 Radiac* (upper left), and the Joint Chemical Agent Detector (upper right).

As a result of their efforts to expedite this development in preparation for *Operation Iraqi Freedom*, Michael Bruch, Aaron Burmeister, Jason Lum, and Bart Everett were each presented Brigadier General Nilo's "Coin of Excellence" by Chemical Regimental Command Sergeant Major CSM Peter Hiltner (Mullens, 2003). A third-generation version of this payload, the *Chemical and Hazardous Avoidance Robotic System (CHARS)* payload was ported to four *iRobot PackBot Explorers* provided via the RS JPO to the 82nd Airborne Division during *Operation Iraqi Freedom* in 2003 (Mullens, 2004).



Figure 245. One of four *iRobot PackBot Explorers* equipped with the *CHARS* payload. Note *iRobot*'s fiber-optic spooler for improved communications when entering caves and bunkers.

Shown in Figure 246a, an experimental tandem *URBOT* configuration facilitated climbing otherwise insurmountable obstacles, but suffered from impaired turning performance, with the ability to spin in place eliminated altogether. An improved linkage designed by lead mechanical engineer Aaron Burmeister allowed the two vehicles to decouple for independent maneuvering, then reconnect

when desired (Figure 246b). There was some interest at the time in using the slave *URBOT* of a tandem pair as a RF communications relay, decoupling it to serve as a static communications node while the lead vehicle continued to advance. This application was never pursued, however, given the far more practical approach of dropping a small RF repeater brick, as further discussed in several later sections, Volume 2.

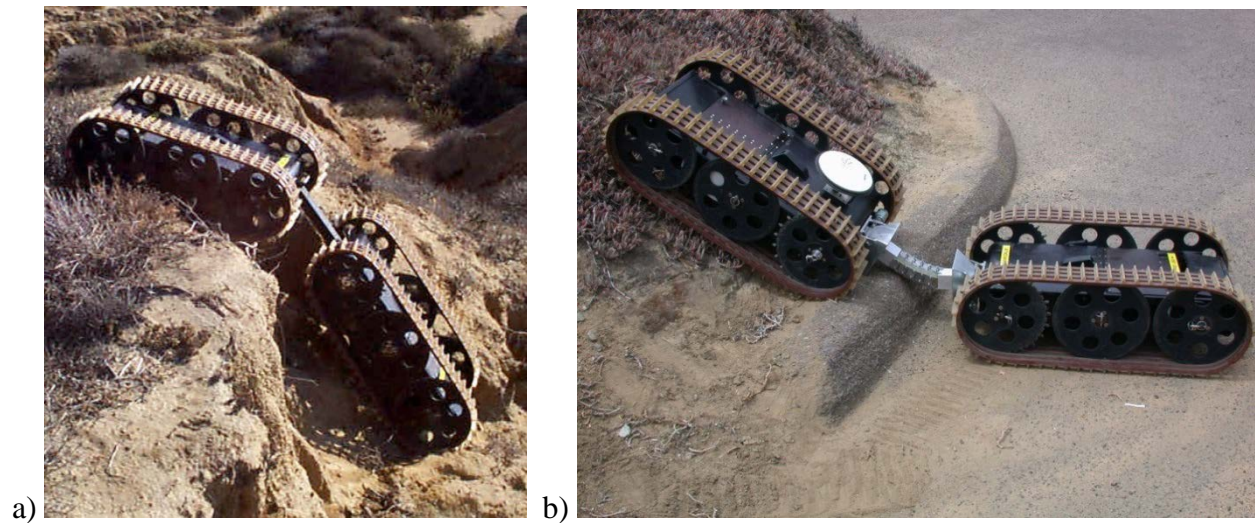

Figure 246. a) A tandem *URBOT* configuration was evaluated for potentially improved mobility over rugged terrain. b) An improved second-generation design featured a flexible linkage that could be automatically decoupled and later reconnected on demand. Note GPS antenna on lead vehicle.

APPENDIX A – NAVSEA POLICY ON AUTOMATION AND ROBOTICS



DEPARTMENT OF THE NAVY

NAVAL SEA SYSTEMS COMMAND
WASHINGTON, D.C. 20382

IN REPLY REFER TO
2020
Ser 90G/63
11 May 1984

From: Commander, Naval Sea Systems Command
To: Distribution

Subj: NAVSEA POLICY RELATIVE TO INTELLIGENT MACHINE AUTOMATION AND
ROBOTICS

1. Intelligent Machine Automation is a new area of advanced technology being extensively researched, developed and applied within industry. As a multi-billion dollar claimant of the industrial resources of the nation, the Navy must capitalize on the tremendous potential of this new technology in the manufacture, maintenance and operation of ship and combat systems when it is cost effective to do so. In this regard, an important goal of this Command is to ensure that the Navy utilizes intelligent systems to reduce total life-cycle costs, guarantee quality, improve readiness, extend endurance, free human assets for higher-order functions, and enhance the attractiveness of shipboard life for Naval personnel.

2. It is recognized that all parts of such a comprehensive goal cannot be achieved simultaneously, but because they are interrelated they should be pursued on an integrated basis. A NAVSEA Robotics Program Plan (under development) will set forth the planned actions to achieve this integration. In the interim, addressees are encouraged to investigate ways to utilize this new technology to improve quality and productivity in their functional areas.

3. The Robotics Program Plan, which will reflect the deliberations and the earlier independent work of the members of the NAVSEA Robotics Council, will fully develop the following approach: establish an understanding and Command awareness of the state-of-the-art and the current prognosis for robotics/Intelligent Machine Automation technology; accumulate and organize a readily accessible data base; critically and constructively review all ongoing projects and ensure that continuing efforts in those projects are addressed to accomplishments consistent with the major thrusts comprising the Command goal; identify Navy needs for robotic applications; match those needs to technology requirements; address through research and development efforts those technology requirements that are not being addressed by the private sector; share technology across as broad a commercial and Navy spectrum as is feasible; develop and demonstrate prototype applications; conduct cost benefit analyses on all promising prototypes; select and implement winners; and, sponsor an appreciation of the robotic power of proven prototypes throughout the Navy.

4. To facilitate the attainment of this goal, LCDR Bart Everett (SEA 90G) is designated as my Special Assistant for Robotics. He will be responsible for developing and executing the Robotics Program Plan; acquiring, synthesizing and disseminating robotics technological information; conducting studies, convening workshops and attending industrial and academic conferences and demonstrations; and participating as a counselor/advisor to NAVSEA in exploratory and decision briefings related to robotics applications in ship and weapon acquisitions, maintenance and operational programs.

5. To minimize redundancy in development efforts, to ensure the compatibility of independently developed systems, to avoid the risks of inappropriately assigned or ill-conceived applications, and to ensure that progress is made on the broad spectrum of the Robotics Program Plan (when promulgated), all NAVSEA robotics efforts shall be coordinated with SEA 90G.

6. The NAVSEA Robotics/Artificial Intelligence Data Base has been established at the Naval Oceans Systems Center to provide the mechanism for descriptive and status information on all ongoing and planned robotics projects. Individual codes initiating programs in robotics are tasked to become aware of and take advantage of ongoing and planned efforts, and to ensure that new initiatives are properly scoped to provide the maximum advantage to the Command.

7. All of the foregoing is intended to provide a Command atmosphere of acceptance for initiatives in this important new technology. I call upon all of you to examine the opportunities that robotics offers to your functional responsibilities, and to consider the allocation of some of your resources in appropriate projects as an investment in the Navy's future.

E. B. FOWLER

Distribution:

SEA 003
SEA 05
SEA 06
SEA 07
SEA 90
SEA 91
SEA 92
FMS 309
FMS 400
PDS 350

APPENDIX B – WHITE PAPER PRESENTED TO ONR/ONT

WHITE PAPER

ROBOTICS TECHNOLOGY
AREAS OF NEEDED RESEARCH AND DEVELOPMENT

Prepared by
LCDR H. R. Everett, USN
OFFICE OF ROBOTICS AND AUTONOMOUS SYSTEMS
NAVAL SEA SYSTEMS COMMAND
WASHINGTON, DC 20362

Presented to
OFFICE OF NAVAL RESEARCH
OFFICE OF NAVAL TECHNOLOGY

6 September 1985

Ser 90G/119

KEY ISSUE

- What is meant by the term "robotics technology"?

POINTS

- Attempts to define a "robot" have been made by many organizations, including the Robotics Industries Association and the Naval Air Systems Command. None of these definitions are adequate for Navy-wide use in both the industrial and non-industrial sense.

- Industry definitions lack operational (non-industrial) orientation

- Service definitions do not adequately address military manufacturing and repair (industrial) applications

- The Joint Technology Panel for Robotics (JTPR), on behalf of the Joint Directors of Laboratories (JDL) has established the following definition of robotics:

"A system incorporating a computer controller to provide autonomy and reprogrammability, which employs an end-effector of some type (manipulator arm or mobile platform), which exhibits flexibility in the roles which it can perform or the equipment with which it interfaces, and which performs tasks of a complexity level that previously required human control."

- The issue, however, is not really the definition of a "robot", but rather what is meant by "robotic technology." The field of robotics (assume for now the JTPR definition) is supported by the disciplines of mathematics, computer science (to include artificial intelligence), mechanical and electrical engineering, materials, physics, psychology, and anatomy. These supporting disciplines required to construct a mechanical system, endow it with intelligence, and provide the necessary sensor data upon which to act, can collectively be termed robotics technology.

CONCLUSIONS

- There is no universally accepted definition of a "robot", but that put forth by the JTPR appears the most appropriate for this discussion. Revision of the JTPR definition will add confusion, but will not necessarily gain acceptance.

- All the supporting disciplines contributing to the successful fielding of an intelligent system as so defined can be considered "robotic technology" when thus employed.

RECOMMENDATION

- Use the JTPR definition of robotics to facilitate determination of technologies that should be pursued in support of robotics system development.

ROBOTICS TECHNOLOGY RESEARCH AND DEVELOPMENT NEEDS

BACKGROUND

For the increasing number of identified potential Navy applications, there are known deficiencies in the supporting technologies that will impede, if not preclude, successful implementation of robotic solutions. These can be subdivided into the two general categories of "Industrial" and "Non-industrial", and are summarized below.

NAVY UNIQUE INDUSTRIAL NEEDS

For the most part these needs reflect the fundamental differences between conventional high-volume assembly-line scenarios which pervade throughout industry, and the very low volume, unstructured environments of Navy applications in manufacturing, but even more importantly, maintenance and repair. It is this latter area where the major impact of robotics on the Navy is predicted to occur, and this arena has been virtually untouched by industrial developments. Examples of needed research and development:

On-line Programming Techniques - Acceptable methods must be developed to allow faster programming for low volume applications. Conventional teach pendants employed by industry are impractical in Navy scenarios. Options include laser-based target designation systems, six degree-of-freedom joysticks, voice input, etc.

Off-line Programming Techniques - Practical methods must be devised to provide three dimensional data describing part geometries for use in generating robot motion programs. This requires interfacing with and augmenting existing and future Computer Aided Design (CAD) systems, and the development of volumetric digitizing techniques and sensors. In addition, process control information depicting parameter values and the sequence of operations must be easily represented in the design database to allow intelligent robotic systems to address low volume, unstructured scenarios typical of Navy applications.

Path Planning for Industrial Robots - Appropriate algorithms must be developed to automatically generate the optimum manipulator and end-effector responses from the geometric and process control data discussed above.

Collision Avoidance - Specialized algorithms must be devised to ensure that robot motion trajectories and process sequences calculated in an offline mode do not create hazardous situations in terms of damage to the workpiece, the equipment, or operating personnel. This requires extensive dynamic modeling of the robotic systems, workpieces, and associated environments.

Sensors to Support Collision Avoidance - Three dimensional imaging sensors are required to ascertain part location and orientation for input to the collision avoidance software routines, as well as to identify discrepancies between expected and actual conditions.

Real Time Process Control Sensors and Algorithms - Automatic and adaptive process control is essential if robotic systems are to be employed in Navy industrial scenarios, due to the unstructured and changing working environments. Research issues include but are not limited to weld pool imaging systems, infrared thermography, paint thickness gauging, surface cleanliness sensors, non-contact measurement techniques, seam tracking systems, weld process control strategies. Typical applications include surface preparation and coating, gas metal arc welding, laser metalworking, application of flame sprayed coatings, grinding and polishing, non-destructive testing, etc.

Dynamic Control Techniques - This is a critical research issue needed to support the design of large robotic systems capable of dealing with massive workpieces as encountered in ship and weapons system manufacturing and repair scenarios. Conventional industrial robots have in comparison rather limited working envelopes. They can therefore assign constant values to control system parameters and mechanical properties such as moments of inertia, static and dynamic frictional forces, etc. In reality, however, these entities are not fixed values but functions of manipulator and end-effector position, velocity, and acceleration, and further affected by changing payloads. Accuracy, repeatability, and system response degrade measurably as real world conditions vary from ideal assumptions, and large systems will require real time calculation of servo control mechanism transfer functions (i.e., gains, damping coefficients, etc.) in order to compensate.

Computer Simulation of Robotic Devices - Much work is needed in this area to provide generic tools needed for off-line programming, collision avoidance, path planning, and dynamic control research.

Generic Rule-Based Architectures - The development of a generic system architecture for networking a modular collection of expert systems with the appropriate modular sensor and controller subsystems is viewed as necessary and desirable for complex Navy applications. Such an architecture would provide for inherent standardization as well as allow for evolutionary system upgrades in response to componentry improvements. The rule-based expert systems address the CAD interface, path planning, collision avoidance, and scheduling functions discussed above, and could be modified through rule changes to accommodate different system applications, without extensive redesign.

Expert System Development - Generic research in expert system development is mandatory for providing the required system intelligence to allow conventional robotic systems to address in

a practical fashion complex Navy needs.

Ship Motion Effects - Research is needed to investigate the effects of ship motion on robot dynamics and equipment life.

NON-INDUSTRIAL NEEDS

The following research and development needs are required to support operational applications of robotics, embodied for the most part in mobile systems. Initial emphasis in prototype development will address hazardous operations (EOD, NBC scenarios) and performance of tasks for which man is incapable. As advances are made in the supporting technologies, there will be a natural trend from teleoperated to semi-autonomous and autonomous systems.

Collision Avoidance for Mobile Robots - Regardless of the application, an essential technological need for any system involving mobility will be the capability to avoid impact with surrounding objects. The problems associated with this need are two-fold: 1) the acquisition of high resolution geometric data describing the environment, and 2) the computational resources needed to interpret that data.

Sensors to Support Collision Avoidance - The acquisition of geometric data requires the development of high resolution, low cost non-contact ranging systems capable of real time operation. Ultrasonic ranging systems have served in this capacity, but suffer from problems associated with extremely poor angular resolution, temperature dependence, specular reflection, interference from adjacent units, and the relatively slow speed of sound in air. Conventional laser rangefinders are prohibitively expensive in terms of initial costs, physical size, and energy requirements. Practical units must be employed in sufficient numbers to rapidly acquire geometric data for use in modeling the robot's surroundings, to support decisions on terrain traversability, and to address environmental "awareness" in general.

Navigational Planning for Mobile Robots - Mobile autonomous and even teleoperated systems must be capable of determining their exact location as well as their orientation at that location in order to effectively maneuver to a desired position, to circumvent known obstructions or hazards, or to avoid detection. Secondly, they must be able to calculate the optimum path for traversing from their current location to the goal, a task which is computationally exhausting.

Sensors to Support Navigational Planning - The task of ascertaining position and orientation will require the development of low cost, accurate, and reliable sensors and/or navigational aids currently unavailable.

Computational Resources - Improved data processing techniques as well as pipeline and parallel processing architectures must be developed to handle the massive amounts of data, calculations, and symbolic reasoning needed to emulate the required degree of intelligence for even the most primitive of systems. This is especially critical for a mobile system where space and energy resources are at a premium.

Application Specific Sensors and Controls - This is the non-industrial analogy to process control sensors in the industrial sense. For a given functional application (firefighting, sentry and security functions, explosive ordnance disposal, mine placement and neutralization, undersea search and recovery, airborne sensor platforms, underwater sensor platforms, weapons handling, material handling, nuclear maintenance, containment, surveillance, etc) there will be required an appropriate sensor suite and associated intelligence to effect the required actions of the system.

Motion Effectors - Research is needed to further develop various types of motion effectors (tracked, wheeled, legged, omni-directional) for optimal maneuverability, dexterity, traction, etc.

Energy Sources - Mobile systems will require a practical onboard source of energy to support drive mechanisms, actuators, sensors, and computational resources.

Man-Machine Interface - Considerable research is needed in this area to effectively enhance the human transfer function and allow efficient interaction between the operator and the complex teleoperated and semi-autonomous systems to be developed.

Training and Self-Diagnostics - The importance of this area cannot be overemphasized. Robotic systems of the future will by necessity be complex in nature, and not well understood by their users. Substantial gains in productivity, quality, or safety could be easily offset by problems associated with operator training, system integration, and maintenance and repair. It is impractical to attempt to provide the skill levels needed to support such equipment through conventional means. Such action would be prohibitively expensive, and even if theoretically possible would suffer from the almost certain loss of highly trained personnel to better paying jobs in industry. Therefore, proposed systems must be fully proficient in diagnosing their own problems. Video disk technology and expert systems must be developed for training and instruction to overcome this problem.

SUMMARY

Ongoing 6.3 development efforts have shown the requirement for more supportive 6.1 and 6.2 research. The examples cited above can be traced to specific prototype development needs in existing NAVSEA programs. The centralized development of generic technology in response to these issues will result in substantial cost savings to the Navy through avoidance of unwanted redundancy. Additional cost savings will be realized through the attainment of application goals otherwise not technologically feasible.

APPENDIX C – CAPTAIN GARRITSON LETTER

NC4(34)/cca
18 May 1982

Vice Admiral E. B. Fowler, Jr, USN
Commander, Naval Sea Systems Command
Washington, DC 20362

Dear Admiral Fowler,

I'm writing to follow up on our conversation of 30 April 1982 relative to robotics. As you may recall, I noted that LCDR Everett of the Naval Engineering Program had achieved instant nation-wide media attention through his robotics-related thesis research and that my observations indicated that LCDR Everett potentially represents a real "blue suit" expert in a field that is about to explode upon the U.S. scene.

I have discussed further the subject of robotics within the Navy with LCDR Everett and several points were brought forth. LCDR Everett is very concerned about efforts to ensure that some naval officers are being given the training and exposure necessary to be able to effectively manage the Navy's interests with regard to robotics. He anticipates a tremendous impact in the very near future which will require many decisions to be made as to what robotics can do in our shipyards, what would be impractical, and which systems would prove cost effective.

To be prepared for this situation he strongly advocates that a few individuals be identified as likely candidates, receive appropriate post-graduate education, and then serve an immediate follow-on tour at facilities actively involved in robotics research, such as NOSC, San Diego. He believes that only through this active association after formal education can an individual get a grasp of this rapidly growing technology which promises to radically change industrial techniques as the Navy knows them today. To expect success otherwise invites financial disaster as well as unreliable productivity as the systems are integrated into the present industrial environment.

I believe that LCDR Everett is an ideal candidate to implement a program to investigate and prepare for this upcoming transition. He has an intense interest in the subject of robotics, and has built four working prototypes, his first when he was a sophomore in high school. He began a systematic approach to achieving his goal of becoming an expert in the field by acquiring a BS in Electrical Engineering at Georgia Tech, and then choosing to work towards an MS in Mechanical Engineering here. He has read extensively outside of the normal program of study in order to obtain the required background in Computer Science while maintaining an overall grade average of 3.8+ to date. His current prototype has won him national recognition as I've noted and an invitation to join Sigma Xi. LCDR Everett intends to continue his personal development in robotics even after departure from the Naval Postgraduate School. It is unlikely that an individual could be found who possesses the required background as well as the drive and personal interest of LCDR Everett in this complex area.

NC4(34)/cca
18 May 1982

Of the many ED officers I've been privileged to meet and observe while assigned to NPS, LCDR Everett comes closest to representing a "blue suit" technical expert in a rapidly growing technological area. I recommend that the Navy take advantage of Everett's expertise in the best manner possible as soon as possible.

Very respectfully,



G. R. GARRITSON

APPENDIX D – NAVSEA MEMO TO NMPC



DEPARTMENT OF THE NAVY

NAVAL SEA SYSTEMS COMMAND
WASHINGTON, DC 20362-5101

IN REPLY REFER TO

2020
Ser 90G/105

From: Commander, Naval Sea Systems Command
To: Commander, Naval Military Personnel Command
Subj: REASSIGNMENT OF LCDR H. R. EVERETT, USN (250-78-4329/1440)
Encl: (1) Captain Garritson's ltr of 18 May 82
(2) NAVSEA Integrated Robotics Program, Annual Report, FY-85.

1. In recognition of LCDR Everett's outstanding performance of duty in establishing the NAVSEA Integrated Robotics Program during his extended assignment in NAVSEA, I invite your attention to the following issues which should be considered in addressing his reassignment.

a) As suggested in enclosure (1), the most appropriate assignment for LCDR Everett following his graduation from the Naval Postgraduate School was to a Navy Laboratory or Center where his classroom theoretical training could be honed in a "hands-on" environment; NOSC was noted as having that kind of work in progress.

b) Immediate needs within this Command at the time made it first necessary to establish a NAVSEA Robotics Program for purposes of technical oversight and coordination. LCDR Everett was selected to give uniformed presence and technically advanced leadership to that effort, thus foregoing the preferred assignment to NOSC.

c) The assessment and organizational planning work which necessitated LCDR Everett's assignment to NAVSEA is essentially completed, and well documented in enclosure (2), which shows that the NAVSEA activity has grown from a few independently originated efforts to an integrated program consisting of more than 70 projects.

d) The program now possesses both the momentum and the infrastructure to sustain itself through a change of leadership; LCDR Everett can therefore be reassigned for the purpose of enhancing his professional technical competence through direct association with technologically demanding projects. The research environment at NOSC is felt to be the most appropriate from the standpoint of exposure to in-house expertise in advanced computer architectures, artificial intelligence, and autonomous systems development.

2. Accordingly, it is my desire that LCDR Everett be assigned to NOSC now for planning purposes, recognizing that execution of the orders may have to be delayed until next fiscal year. Anticipating his detachment not later than October 1986, search must begin immediately for a technically qualified relief (1440/1460 with a masters degree in one or more of the robotics component technology disciplines). It is permissible to gap the billet in the interim in the interest of identifying the best qualified candidate.

Copy to:

SEA 90
NOSC

APPENDIX E – CENTER AND BRANCH NAMES

Date	Center	Branch	Code	Branch Head
1984	NOSC	Autonomous Systems	442	Scott Harmon
1985	NOSC	Autonomous Systems	442	Doug Gage
1986	NOSC	Autonomous Systems	442	Doug Gage
1987	NOSC	Autonomous Systems	442	Doug Gage
1988	NOSC	Advanced Technology Development	535	Ray Glass
1989	NOSC	Advanced Technology Development	535	Ray Glass
1990	NOSC	Advanced Technology Development	535	Steve Martin
1991	NOSC	Advanced Technology Development	535	Steve Martin
1992	NCCOSC	Advanced Technology Development	535	Walt Aviles
1993	NCCOSC	Adaptive Systems	531	Walt Aviles
1994	NCCOSC	Adaptive Systems	531	LCDR Don DeMuth
1995	NCCOSC	Adaptive Systems	531	LCDR Don DeMuth
1996	NCCOSC	Adaptive Systems	D371	John Bott
1997	SSC San Diego	Adaptive Systems	D371	John Bott
1998	SSC San Diego	Adaptive Systems	D371	John Bott
1999	SSC San Diego	Adaptive Systems	D371	John Bott
2000	SSC San Diego	Adaptive Systems	D371	Robin Laird
2001	SSC San Diego	Adaptive Systems	D371	Robin Laird
2002	SSC San Diego	Robotic Systems	2371	Robin Laird
2003	SSC San Diego	Robotic Systems	2371	Robin Laird
2004	SSC San Diego	Unmanned Systems	2371	Robin Laird
2005	SSC San Diego	Unmanned Systems	2371	Hoa Nguyen
2006	SSC San Diego	Unmanned Systems	2371	Hoa Nguyen
2007	SSC San Diego	Unmanned Systems	7171	Hoa Nguyen
2008	SSC Pacific	Unmanned Systems	7171	Hoa Nguyen
2009	SSC Pacific	Unmanned Systems	7171	Hoa Nguyen
2010	SSC Pacific	Unmanned Systems	7171	Hoa Nguyen
2011	SSC Pacific	Unmanned Systems	7171	Hoa Nguyen
2012	SSC Pacific	Unmanned Systems Group	71710/20	Hoa Nguyen
2013	SSC Pacific	Unmanned Systems Group	71710/20	Tracy Pastore/Rachel TenWolde
2014	SSC Pacific	Unmanned Systems Group	71710/20	Tracy Pastore/Rachel TenWolde
2015	SSC Pacific	Unmanned Systems Group	71710/20	Tracy Pastore/Rachel TenWolde

NOSC- Naval Ocean Systems Center

NCCOSC - Naval Command Control and Ocean Surveillance Center

SSC San Diego- Space and Naval Warfare Systems Center San Diego

SSC Pacific- Space and Naval Warfare Systems Center Pacific

APPENDIX F – PATENT AWARDS AND APPLICATIONS

PATENTS AWARDED

1. Blackburn, M., and N. Tran. “Method for Vehicle Collision Avoidance,” U.S. Patent # 8,175,796, awarded 8 May, 2012.
2. Bruch, M., and J. Larson. “Obstacle Avoidance System and Method,” U.S. Patent #7,865,277, awarded 4 January, 2011.
3. Bruch, M., and J. Larson. “Method for Determining Projected Obstacle Areas for Moving Obstacles,” U.S. Patent #7,957,858, awarded 7 June, 2011.
4. Bruch, M., and J. Larson. “Registration of Latitude/Longitude Coordinates Using Range-Detection Sensors and Digital Nautical Charts,” U.S. Patent #8,154,438, awarded 10 April, 2012.
5. Burmeister, A. “System and Method for Measuring an Object’s Center of Gravity,” Navy Case #100,011, U.S. Patent # 8,229,701, awarded 24 July, 2012.
6. Everett, H. R., and C. S. Wright. “Tactile Bumper for a Mobile Robot or Platform,” Navy Case #68,615, U.S. Patent #4,596,412, awarded 24 June, 1986.
7. Everett, H. R. “Programmable Near-Infrared Ranging System,” Navy Case #70,153, U.S. Patent #4,851,661, awarded 25 July, 1989.
8. Everett, H. R., and G. A. Gilbreath. “Intelligent Security Assessment System,” Navy Case #71,393, U.S. Patent #4,857,912, awarded 15 August, 1989.
9. Everett, H. R. “Optical Motion Detector Detecting Visible and Near-Infrared Light,” Navy Case #71816, U.S. Patent #4,902,887, awarded 20 February, 1990.
10. Everett, H. R. “Pneumatic Actuator with Hydraulic Control,” Navy Case #70,227, U.S. Patent #5,058,385, awarded 22 October, 1991.
11. Everett, H. R. “Reconfigurable Video Line Digitizer,” Navy Case #72,498, U.S. Patent #5,034,817, awarded 23 July 1991.
12. Everett, H. R. “Intelligent Battery Charging System,” Navy Case #70,154, U.S. Patent #5,045,769, awarded 3 September, 1991.
13. Everett, H. R. “Pneumatic Actuator with Hydraulic Control,” Navy Case #70,227, U.S. Patent #5,161,449, awarded 10 November, 1992.
14. Everett, H. R., G. A. Gilbreath, R.T. Laird. “Navigational Control System for an Autonomous Vehicle,” Navy Case #72,770, U.S. Patent #5,111,401, awarded 5 May, 1992.
15. Everett, H. R., and G. A. Gilbreath. “Method and System for Fusing Data from Fixed and Mobile Security Sensors,” Navy Case #72,775, U.S. Patent #5,202,661, awarded 13 April, 1993.
16. Everett, H. R. “Doorway Transit Navigational Referencing System,” Navy Case #73419, U.S. Patent #5,276,618, awarded 4 January, 1994.
17. Everett, H.R., and G. A. Gilbreath. “Reflexive Teleoperated Control System for Remotely Controlled Vehicle,” Navy Case #72,949, U.S. Patent #5,307,271, awarded 26 April, 1994.
18. Everett, H. R., and J. M. Nieuwma. “Feedback System for Remotely Operated Vehicles,” Navy Case #73,322, U.S. Patent #5,309,140, awarded 3 May, 1994.
19. Everett, H.R., and R. P. Smurlo. “System for Detecting Perturbations in an Environment Using Temporal Sensor Data,” Navy Case #75,144, U.S. Patent #5,493,273, awarded 20 February, 1996.
20. Everett, H.R., R. T. Laird, G. A. Gilbreath, and T. A. Pastore. “System for Assigning Computer Resources to Control Multiple Computer Directed Devices,” Navy Case #76,192, Patent #5,659,779, awarded 19 August, 1997.
21. Everett, H.R., G. A. Gilbreath, R. S. Inderieden, T. T. Tran, and J. H. Holland. “Optically Based Position Location System for an Autonomous Guided Vehicle,” Navy Case #77,796, U.S. Patent #5,812,267, awarded 22 September, 1998.
22. Everett, H. R., and L. Albuquerque. Scerri, P., “Command and Control System for Integrated Human-Canine-Robot Interaction,” Navy Case #101,887, U.S. Patent # 9,031,714, awarded 12 May, 2015.
23. Gilbreath, G. A., D. Powell, and D. Barbour. “System and Method for Displaying Data from Multiple Devices on a Single User Interface,” U.S. Patent #9,030,491, awarded 12 May, 2015.

24. Holtz, K., A. Burmeister, N. Pezeshkian, A. Hart, and H. Nguyen. "System and Method for Remotely Operated Deployment and Retrieval of Communication Relays," Navy Case #101,287, U.S. Patent #9,094,082, awarded 28 July, 2015.
25. Pezeshkian, N. "Close-Proximity Communications System Using Capacitively Coupled Signal Transfer," Navy Case #99,750, U.S. Patent #8,396,136, awarded 12 March, 2013.
26. Pezeshkian, N., A. Burmeister, and H. Nguyen, H., "Remotely Operated Illumination Device," Navy Case #100,338, U.S. Patent #8,219,023, awarded 10 July, 2012
27. Pezeshkian, N., A. Burmeister, and H. Nguyen. "Relay Device Deployer System," U.S. Patent #8,103,212, awarded 24 January, 2012.
28. Pezeshkian, N., A. Burmeister, H. Nguyen, K. Holtz, and J. Cruikshanks. "Improved Relay Device Deployer System," Navy Case #99,917, U.S. Patent #8,103,212, awarded 24 January, 2012.
29. Pezeshkian, N., A. Burmeister, H. Nguyen, and K. Holtz. "Next Generation Automatically Deployed Communication Relay," Navy Case #99526, U.S. Patent #8,427,383, awarded 23 April, 2013.
30. Pezeshkian, N., A. Burmeister., and H. G. Nguyen. "Wireless Self-Contained Relay Device," U.S. Patent #8,849,189, awarded 30 September, 2014.
31. Pezeshkian, N., A. Burmeister, and H. Nguyen. "Wireless Self-Contained Relay Device," Navy Case #98,480, U.S. Patent #8,849,189, 30 September, 2014.⁵⁴
32. Pezeshkian, N., A. Burmeister, and H. Nguyen. "Relay Device Deployer System," Navy Case #98,975, U.S. Patent #8,909,130, 9 December, 2014.
33. Pezeshkian, N., A. Burmeister, K. Holtz, A. Hart, H. Nguyen, and L. Roth. "Method of Maintaining an Ad Hoc Communications Network Between a Base and Mobile Platform," Navy Case #102,533, U.S. Patent 9,107,081, 11 August, 2015.
34. Pezeshkian, N., J. D. Neff, and H. R. Everett. "Adaptive Electronic Camouflage," Navy Case #101,118, U.S. Patent #9175930, awarded 3 November, 2015.
35. Tran, N., and M. Blackburn. "Active Composite RFID Tag for Object Localization and Instruction," U.S. Patent #8,094,012, awarded 10 January, 2012.
36. Tran, N., and M. Blackburn, M., "Self-Contained Sensor Package for Water Security and Safety," U.S. Patent #8,134,462, awarded 13 March, 2012.
37. Tran, N., M. Blackburn, and H. Phan. "Hall-Effect Finger-Mounted Computer Input Device," U.S. Patent #8,246,462, awarded 21 August, 2012.
38. Tran, N., S. Fugate, L. Duffy, and H. Phan. "RFID System for Gesture Recognition, Information Coding, and Processing," U.S. Patent #8,279,091, awarded 2 October, 2012.
39. Tran, N. "Hydraulic-Based Spherical Robot," U.S. Patent # 8,316,970, awarded 27 November, 2012.
40. Tran, N., S. Fugate, M. Ceruti, L. Duffy, H. Phan. "Hall-Effect System for Gesture Recognition, Information Coding, and Processing," U.S. Patent #8,421,448, awarded 16 April, 2013.
41. Tran, N., M. Bruch, R. Adam, A. Burmeister, A. Rahimi. "Remotely Controlled Traffic Management System," U.S. Patent #8,222,750, awarded 15 April, 2013.
42. Tran, N., M. Bruch, R. Adam, A. Burmeister, and A. Rahimi. "Remotely Controlled Traffic Management System," U.S. Patent #8,442,750, awarded 14 May, 2013.
43. Tran, N., H. Phan, T. Ton, J. Rockway, and A. Ton. "Wand Controller for Aircraft Marshalling," U.S. Patent #8,456,329, awarded 4 June, 2013.
44. Tran, N., M. Bruch, H. Phan, and S. Fugate. "Active Capacitive Control Stylus," U.S. Patent #8,648,837, awarded 11 February, 2014.
45. Tran, N. "RF-Based System for Close-Proximity Data and Energy Transfer," U.S. Patent #8,660,491, awarded 25 February, 2014.
3. Burmeister, A. "Manually Deployed Communication Relay," U.S. Patent #9094082, awarded .

Applications Submitted

1. Rosen, G., B. Chadwick, B. Nguyen, A. Burmeister, and H. Nguyen. "Surface Sediment Core Catcher," Navy Case #102,059, filed 5 March, 2014.
2. Burmeister, A., N. Tran, M. Bruch, R. Halterman, J. Lum, and M. Tjersland. "Nodding Mechanism of a Single-Scan Sensor," Navy Case #100,892, filed 28 November, 2013.

⁵⁴ Received the "Michael Kagan 2014 Invention of the Year Award."

3. Burmeister, A. "Manually Deployed Communication Relay," Navy Case #101,287, filed 23 May, 2012.
4. Holtz, K., A. Burmeister, N. Pezeshkian, A. Hart, and H. Nguyen. "System and Method for Remotely Operated Deployment and Retrieval of Communication Relays," Navy Case #101,207, filed 14 May, 2012.
5. Larson, J., and N. Tran. "Building Inspection and Mapping Device," Navy Case #101,320, 28 November, 2013.
6. Nguyen, H., and A. Burmeister. "VTOL UAV Landing on Uneven or Sloped Terrain," Navy Case #102,573, filed 22 May, 2013.
7. Nguyen, H. "Method for Automatic Recovery of Lost Communications for Unmanned Ground Robots," Navy Case 101,908, filed 29 November, 2012.
8. Talke, K., A. Burmeister, and D. Leung. "Stowable Payload Carrier for a Ground Vehicle," Navy Case #102,534, filed 5 May, 2014.

APPENDIX G – PROJECT HISTORY CHART

REPLACE THIS PAGE WITH
717 Unmanned Systems Group History - 11 x 17 inch page
folded to fit 8 ½ x 11 inches

The back of the 11 x 17 page is blank



717 Unmanned Systems Group History: Air, Land, and Sea

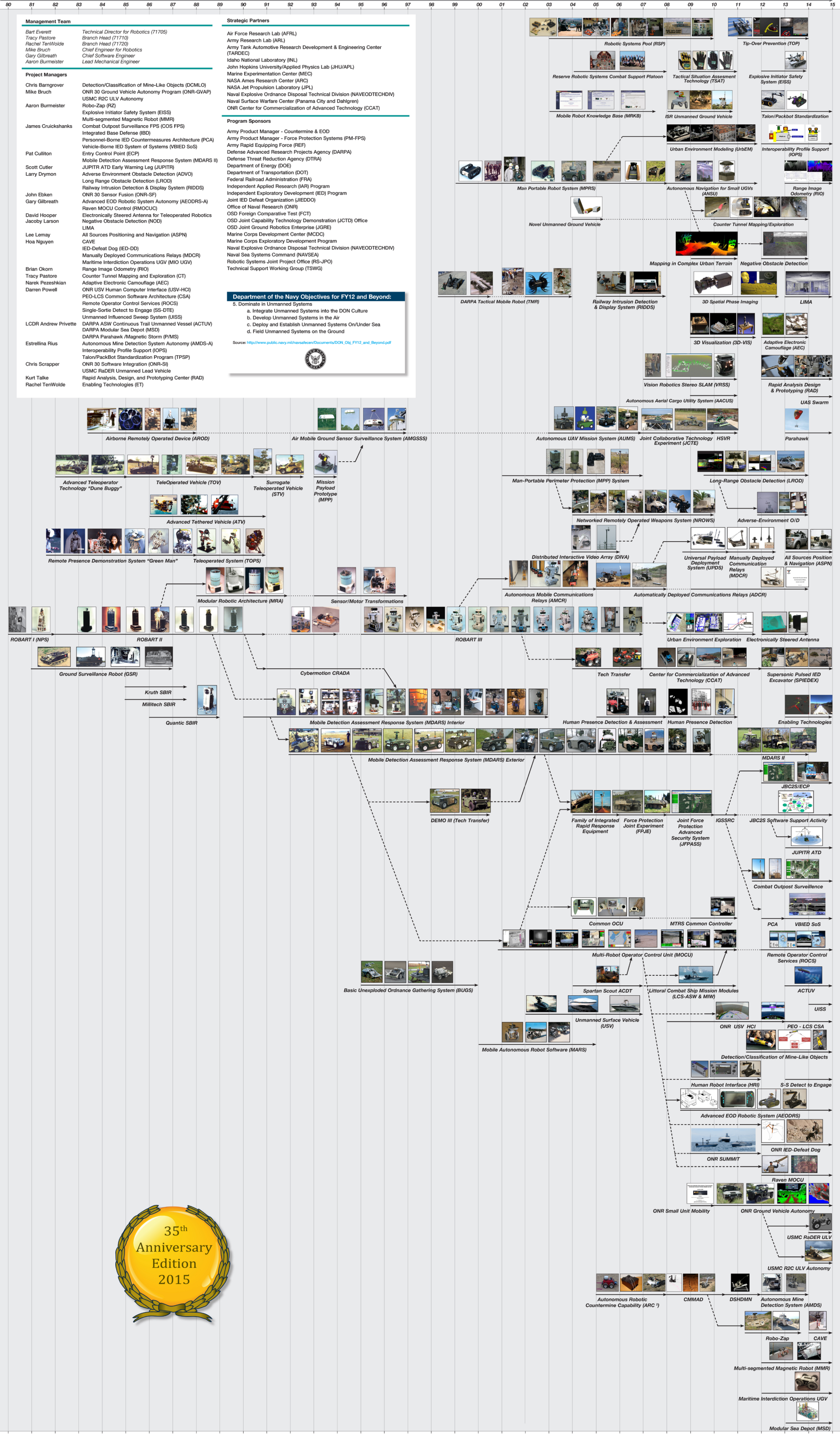

Management Team

Bart Everett Technical Director for Robotics (71705)
Tracy Pastore Branch Head (71710)
Rachel TenWolde Branch Head (71720)
Mike Bruch Chief Engineer for Robotics
Gary Gilbreath Chief Software Engineer
Alison Burmeister Lead Mechanical Engineer

Project Managers

Chris Barngrover Detection/Classification of Mine-Like Objects (DCMLO)
Mike Bruch ONR 30 Ground Vehicle Autonomy Program (ONR-GVAP)
Aaron Burmeister USMC R2C ULV Autonomy
 Robo-Zap (RZ)
 Explosive Initiator Safety System (EISS)
 Multi-segmented Magnetic Robot (MMR)
 Combat Outpost Surveillance FPS (COS FPS)
 Integrated Base Defense (IBD)
 Personnel-Borne IED Countermeasures Architecture (PCA)
 Vehicle-Borne IED System of Systems (VBIED SoS)
 Entry Control Point (ECP)
 Mobile Detection Assessment Response System (MDARS II)
Pat Culliton JUPITR ATD Early Warning Leg (JUPITR)
Scott Cutler Adverse Environment Obstacle Detection (ADVO)
Larry Drymon Long Range Obstacle Detection (LROD)
 Railway Intrusion Detection & Display System (RIDDS)
 ONR 30 Sensor Fusion (ONR-SF)
 Advanced EOD Robotic System (AEODRS-A)
 Raven MOCU Control (RMOUCG)
 Electronically Steered Antenna for Teleoperated Robotics
 Negative Obstacle Detection (NOD)
 LIMA
 All Sources Positioning and Navigation (ASPN)
 CAVE
 IED-Defeat Dog (IED-DD)
 Manually Deployed Communications Relays (MDCR)
 Maritime Interdiction Operations UGV (MIO UGV)
 Range Image Odometry (RIO)
 Counter Tunnel Mapping and Exploration (CT)
 Adaptive Electronic Camouflage (AEC)
 ONR USV Human Computer Interface (USV-HCI)
 PEO-LCS Common Software Architecture (CSA)
 Remote Operator Control Services (ROCS)
 Single-Sortie Detect to Engage (SS-DTE)
 Unmanned Influenced Sweep System (IUSS)
 DARPA ASW Continuous Trail Unmanned Vessel (ACTUV)
 DARPA Modular Sea Depot (MSD)
 DARPA Parahawk/Magnetic Storm (PMS)
 Autonomous Mine Detection System Autonomy (AMDS-A)
 Interoperability Profile Support (IOPS)
 Talon/PackBot Standardization Program (TPSP)
 ONR 30 Software Integration (ONR-SI)
 USMC RaDER Unmanned Lead Vehicle
 Rapid Analysis, Design, and Prototyping Center (RAD)
 Enabling Technologies (ET)

Strategic Partners

Air Force Research Lab (AFRL)
 Army Research Lab (ARL)
 Army Tank Automotive Research Development & Engineering Center (TARDEC)
 Idaho National Laboratory (INL)
 John Hopkins University/Applied Physics Lab (JHU/APL)
 Marine Experimentation Center (MEC)
 NASA Ames Research Center (ARC)
 NASA Jet Propulsion Laboratory (JPL)
 Naval Explosive Ordnance Disposal Technical Division (NAVEDTECHDIV)
 Naval Surface Warfare Center (Panama City and Dahlgren)
 ONR Center for Commercialization of Advanced Technology (CCAT)

Program Sponsors

Army Product Manager - Countermine & EOD
 Army Product Manager - Force Protection Systems (PM-FPS)
 Army Rapid Equipping Force (REF)
 Defense Advanced Research Projects Agency (DARPA)
 Defense Threat Reduction Agency (DTRA)
 Department of Energy (DOE)
 Department of Transportation (DOT)
 Federal Railroad Administration (FRA)
 Independent Applied Research (IAR) Program
 Independent Exploratory Development (IED) Program
 Joint IED Defeat Organization (JIEDDO)
 Office of Naval Research (ONR)
 OSD Foreign Comparative Test (FCT)
 OSD Joint Capability Technology Demonstration (JCTD) Office
 OSD Joint Ground Robotics Enterprise (JGRE)
 Marine Corps Development Center (MCDCG)
 Marine Corps Exploratory Development Program
 Naval Explosive Ordnance Disposal Technical Division (NAVEDTECHDIV)
 Naval Sea Systems Command (NAVSEA)
 Robotic Systems Joint Project Office (RS-JPO)
 Technical Support Working Group (TSWG)

Department of the Navy Objectives for FY12 and Beyond:

5. Dominate in Unmanned Systems
 - a. Integrate Unmanned Systems into the DON Culture
 - b. Develop Unmanned Systems in the Air
 - c. Deploy and Establish Unmanned Systems On/Under Sea
 - d. Field Unmanned Systems on the Ground

Source: http://www.public.navy.mil/navasocentr/Documents/DON_Objs_FY12_and_Beyond.pdf



GLOSSARY

ACS	Autonomous Capabilities Suite
ACTD	Advanced Concept Technology Demonstration
ADVO	Adverse Environment Obstacle Detection
AI	Artificial Intelligence
AIS	Automatic Identification System (AIS)
AMDS	Autonomous Mine Detection System
ARPA	Automated Radar Plotting Aid
ARPA	Advanced Research Projects Agency
ASB	Army Science Board
ASPN	All Sources Positioning and Navigation
ATD	Advanced Technology Demonstration
ATRV	All Terrain Robotic Vehicle
BAA	Broad Agency Announcement
BAIS	Battlefield Anti-Intrusion System
BYU	Brigham Young University
CAA	Center for Army Analysis
CARACaS	Control Architecture for Robotic Agent Command and Sensing
CCAT	Center for Commercialization of Advanced Technology
CFPI	Comprehensive Force Protection Initiative
CMU	Carnegie Mellon University
C-RAM	Counter-Rocket Artillery and Mortar
CODEC	Coder Decoder
COEE	Concept of Employment Exercise
COTS	Commercial Off The Shelf
CRADA	Cooperative Research and Development Agreement
DARPA	Defense Advanced Research Projects Agency
DLA	Defense Logistics Agency
DoD	Department of Defense
DoF	Degree of Freedom
DSEHDMN	Dismounted Standoff Explosive Hazard Detection Marking and Neutralization
ECP	Engineering Change Proposal
EDO	Engineering Duty Officer
EISS	Explosive Initiator Safety System
EOD	Explosive Ordnance Disposal
eTASS	Enhanced Tactical Automated Security System
EUA	Early User Appraisal
FIRRE	Family of Integrated Rapid Response Equipment
GDRS	General Dynamics Robotic Systems
IED	Improvised Explosive Device
IFF	Identification Friend or Foe
IHEODTD	Indian Head Explosive Ordnance Disposal Technology Division
INCONUS	In the Continental United States
INEEL	Idaho National Engineering and Environmental Laboratory
INL	Idaho National Laboratory
IP	Internet Protocol
IPT	Integrated Product Team
J AUS	Joint Architecture for Unmanned Systems
JBC2S	Joint Battlespace Command and Control System
JCTD	Joint Capability Technology Demonstration
JPL	Jet Propulsion Laboratory
JGRE	Joint Ground Robotics Enterprise

JRP	Joint Robotics Program
JUONS	Joint Urgent Operational Needs Statement
JUPITR	
LIDAR	Light Detection and Ranging
LIMA	
LUT	Limited User Testing
MCTSSA	Marine Corps Tactical Systems Support Activity
MDARS	Mobile Detection Assessment Response System
MDARS-I	Mobile Detection Assessment Response System - Interior
MDARS-E	Mobile Detection Assessment Response System - Exterior
MDCR	Manually-Deployed Communication Relays
MRHA	Multi-Robot Host Architecture, later Multi-Resource Host Architecture
MPRS	Man-Portable Robotic System
MTRS	Man-Transportable Robotic System
MOCU	Multi-robot Operator Control Unit, later Multi-Robot Operator Control Unit
MOOS	Mission Oriented Operating Suite
NASA	National Aeronautics and Space Administration
NAVEODTECHDIV	Naval Explosive Ordnance Disposal Technology Division
NNSS	Nevada National Security Site
NPS	Naval Postgraduate School
NAVSEA	Naval Sea Systems Command
NCCOSC	Naval Command Control and Ocean Surveillance Center
NOSC	Naval Ocean Systems Center
NSWC	Naval Surface Warfare Center, previously Naval Surface Weapons Center
NSWC	Naval Special Warfare Command
NREIP	Naval Research Enterprise Intern Program
OCONUS	Outside the Continental United States
OCU	Operator Control Unit
OEF	Operation Enduring Freedom
OIF	Operation Iraqi Freedom
ONR	Office of Naval Research
ONT	Office of Naval Technology
OPMG	Army Office of the Provost Marshal General
OSD	Office of the Secretary of Defense
PCA	Principal Component Analysis
PCB	Printed Circuit Board
PCMCIA	Personal Computer Memory Card International Association
PdM – PSE	Product Manager – Physical Security Equipment
PdM – RUS	Product Manager – Robotic and Unmanned Sensors (
PEOCBD	Joint Program Executive Officer for Chemical and Biological Defense
PM – UAS	Program Manager – Unmanned Air Systems
PSEAG	Physical Security Equipment Action Group
PTZ	Pan, Tilt, Zoom
RaDER	
RAID	Robotics and Artificial Intelligence Database
RDT&E	Research, Development, Test and Evaluation
RIDDS	Railway Intrusion detection Display System
RMP	Robotic Mobility Platform
ROCC	Robotic Operations Command Center
ROCS	Remote Operator Control Services
ROS	Robot Operating System
RS JPO	Robotic Systems Joint Program Office
RSP	Robotic Systems Pool
RSSI	Signal Strength Indicator
RST	Robotic Systems Technology
SAE	Society of Automotive Engineers

SAIC	Science Applications International Corporation
SDD	System Development and Demonstration
SINCGARS	Single Channel Ground and Airborne Radio System
SLAM	Simultaneous Localization and Mapping
SPAWAR	Space and Naval Warfare Systems Center
SPI	Security Patrol Instrumentation
SRI	Stanford Research Institute, later SRI International
STANAG	Standardization Agreement
SwRI	Southwest Research Institute
TAGS	Tactical Amphibious Ground Surveillance
TCIM	Tactical Communication Interface Module
TFT	Technical Feasibility Test
TIS	Thermal Imaging System
TMR	Tactical Mobile Robotics
TRC	Transitions Research Corporation
UAS	Unmanned Air System
UAV	Unmanned Air Vehicle
UGV	Unmanned Ground Vehicle
UGV JPO	Unmanned Ground Vehicle Joint Program Office
UHF	Ultra High Frequency
UISS	UIKit Style Sheets
URBOT	Urban Robot
USV	Unmanned Surface Vehicle
UUV	Unmanned Undersea Vehicle
UXV	Unmanned (generic type)Vehicle
VHF	Very High Frequency
VIS	Video Imaging System
WLAN	Wireless Local Area Network
WTC	World Trade Center
WWI	World War I
WWII	World War II

REFERENCES/BIBLIOGRAPHY

- AFRL (Air Force Research Lab). 2005 “Engineers Deliver Robot to Neutralize Remove Explosives.” Space Daily (30 June). Available online at <http://www.spacedaily.com/news/robot-05zx.html>. Accessed 23 March 2016.
- Anderson, C. 2006. “The 50 Best Robots Ever,” *Wired Magazine* (January).
- Anderson, D. K. 2014. “NPS Thesis Assistance; Unmanned Ground Vehicles,” e-mail correspondence, 2 September.
- Anhalt, D., and J. Spofford, J. 1999. “Use of Mission Roles as a Robotic Tasking Device.” *Proceedings of SPIE 3838: Mobile Robots XIV*. 19 September, Boston, MA.
- Arkin, R. C., T. R. Collins, and Y. Endo. 1999. “Tactical Mobile Robot Mission Specification and Execution.” *Proceedings of SPIE 3838: Mobile Robots XIV*. 15 November, Boston, MA.
- Aviles, W. A., D. W. Gage, S. Y. Harmon, and G. L. Bianchini. 1985. “An Architecture for the Coordination and Control of Complex Robotic Subsystems.” *Proceedings of the 1985 Conference on Intelligent Systems and Machines* (pp. 40–46). 23–24 April, Rochester MI.
- Aviles, W. A., T. W. Hughes, H. R. Everett, A. Y. Umeda, S. W. Martin, A. H. Koyamatsu, M. R. Solorzano, R. T. Laird, and S. P. McArthur. 1990. “Issues in Mobile Robotics: The Unmanned Ground Vehicle Program TeleOperated Vehicle (TOV).” *Proceedings of the SPIE Conference on Mobile Robots V* (pp. 587–597). 8–9 November, Boston, MA.
- Axe, D. 2006. “Enter the BomBot,” *DefenseTech* (June 13). Available online at <http://defensetech.org/2006/06/13/enter-the-bombot/>. Accessed 23 March 2016.
- Babb, C., Ed. 1990. “NOSC to Form Cooperative R&D Agreement with Industry,” *OutLook* (11 May). Naval Ocean Systems Center (NOSC), San Diego, CA.
- Barnes, M., T. Heath-Pastore, and R. Hallman. 2005. “Mobile Robot Knowledge Base.” *Proceedings of SPIE 5804: Unmanned Ground Vehicle Technology VII*. 29–31 March, Orlando, FL.
- Bassett, W. G. 1987. “A Dynamic Simulation and Feedback Control Scheme for the U.S. Marine Corps' Airborne Remotely Operated Device (AROD).” Master’s thesis. Naval Postgraduate School, Monterey, CA. Available online at <http://calhoun.nps.edu/bitstream/handle/10945/22758/dynamicsimulatio00bass.pdf?sequence=1>. Accessed 24 March 2015.
- Blackburn, M. R., and H. G. Nguyen. 1994. “Robotic Sensor-Motor Transformations.” *Proceedings of the 1994 ARPA Image Understanding Workshop*. 13–16 November, Monterey, CA.
- Blackburn, M. R., and H. G. Nguyen. 1994. “Autonomous Visual Control of a Mobile Robot.” *Proceedings, 1994 ARPA Image Understanding Workshop*. 13–16 November, Monterey, CA.
- Blackburn, M. R., and H. G. Nguyen. 1995. “Vision Based Autonomous Robot Navigation: Motion Segmentation.” *Proceedings of the 28th International Symposium on Automotive Technology and Automation (ISATA) Conference on Robotics, Motion, and Machine Vision in the Automotive Industries* (pp. 353–360). 18–22 September, Stuttgart, Germany.
- Blackburn, M. R., H. G. Nguyen, and P. K. Kaomea. 1987. “Machine Visual Motion Detection Modeled on Vertebrate Retina.” *Proceedings of SPIE 980: Underwater Imaging* (pp. 90–98). 18 August, San Diego, CA
- Borenstein, J., H. R. Everett, and L. Feng. 1996. *Navigating Mobile Robots: Systems and Techniques*, A. K. Peters, Ltd., Wellesley, MA.
- Borenstein, J., H. R. Everett, L. Feng, and D. Wehe. 1997. “Mobile Robot Positioning: Sensors and Techniques,” *Journal of Robotic Systems*, vol. 14, no. 4, pp. 231–249.
- Bradley, D. M., D. Silver, and S. Thayer. 2004. “A Regional Point Descriptor for Global Topological Localization in Flooded Subterranean Environments.” *Proceedings of the IEEE Conference on Robotics, Automation and Mechatronics* (pp. 440–445). 1–3 December, Singapore.

- Bradley, T., W. Cadwallander, P. Calella, K. Eng, H. R. Everett, M. Friedman, T. Lu, C. Periera, R. Smurlo, R. Torres, and D. Troast. 1993. "Mobile Detection Assessment and Response System (MDARS) Remote Platform Architecture." Technical Report NDTM-93005 (July). Armament Research Development and Engineering Center, Picatinny Arsenal, NJ.
- Brooks, R. A. 2002. *Flesh and Machines: How Robots Will Change Us*. Pantheon Books, New York, NY.
- Bruch, M. H., R. T. Laird, and H. R. Everett. 2000. "Challenges for Deploying Man-portable Robots into Hostile Environments." *Proceedings of SPIE 4195: Mobile Robots XV*. 5–8 November, Boston, MA.
- Bruch, M. H., G. A. Gilbreath, J. W. Muehlhauser, and J. Q. Lum. 2002. "Accurate Waypoint Navigation Using Non-differential GPS." *Proceedings of the AUVSI Unmanned Systems Conference 2002*. 9–11 July, Lake Buena Vista, FL.
- Bruch, M. H., J. Lum, S. Yee, and N. Tran. 2005. "Advances in Autonomy for Small UGVs." *Proceedings of SPIE 5804: Unmanned Ground Vehicle Technology VII*. 29–31 March, Orlando, FL.
- Bryan, W. D., H. G. Nguyen, and D. W. Gage. 1998. "Man-Portable Networked Sensor System." *Proceedings of SPIE 3394: Sensor Technology for Soldier Systems* (pp 79–88). 13–15 April, Orlando, FL.
- Cadwallander, W.K., T. M. Bradley, K. Eng, K., T. M. Lu, M. Torres, and A. Franz. 1993. "The MDARS Technical Feasibility Test (TFT) Platform: 1989–1991." Technical Memo ASTDTM 93006, FSN 93007, Rev. 1 (26 August). U.S. Army Armament Research Development and Engineering Center, Picatinny Arsenal, NJ.
- Cadwallander, W. K., and S. H. Smith. 1993. "Development of a Special Purpose Embedded Computer for the Mobile Detection Assessment Response System (MDARS)." Technical Memo NDTM FSN 93001, Rev. 1 (13 January). U.S. Army Armament Research Development and Engineering Center, Picatinny Arsenal, NJ.
- Carroll, D., H. R. Everett, G. Gilbreath, and K. Mullens. 2002. "Extending Mobile Security Robots to Force Protection Missions." *AUVSI Unmanned Systems 2002*. July 9–11, Lake Buena Vista, FL. Available online at http://www.public.navy.mil/spawar/Pacific/Robotics/Documents/Publications/2002/auvsi02_mdars.pdf. Accessed 14 April 2016.
- Carroll, D., G. A. Gilbreath, and H. R. Everett. 2002. "Extending Mobile Security Robots to Force Protection Missions." *Proceedings of the AUVSI Unmanned Systems Conference 2002*. 9–11 July, Lake Buena Vista, FL.
- Carroll, D., G. Gilbreath, K. Grant, and L. Day. 2003. "Command and Control for Mixed Manned and Unmanned Security Forces." *AUVSI Unmanned Systems in International Security 2003 (USIS 03)*. 9–12 September, London, United Kingdom. Available online at www.dtic.mil/dtic/tr/fulltext/u2/a422019.pdf. Accessed 14 April 2016.
- Carroll, D., C. Nguyen, H. R. Everett, and B. Frederick. 2005. "Development and Testing for Physical Security Robots." *Proceedings of SPIE 5804: Unmanned Ground Vehicle Technology VII*. 29–31 March, Orlando, FL.
- Carroll, D. M., H. G. Nguyen, R. T. Laird, and H. R. Everett. 2005. "Center of Excellence for Small Robots." *Proceedings of SPIE 5804: Unmanned Ground Vehicle Technology VII*. 29–31 March, Orlando, FL.
- CBD (Chemical and Biological Defense). 1995. "Collaborative Behavior Demonstration." Program handout. *Unmanned Systems Capabilities Conference II*, 15 December, San Diego, CA.
- Chatfield, J. A. 1995. "Force Feedback for Anthropomorphic Teleoperated Mechanisms." Master's thesis (June). Naval Postgraduate School, Monterey, CA.

- Chen, A., and X. Yuille. 2004. "Detecting and Reading Text in Natural Scenes." *Proceedings of the IEEE Conference on Computer Vision and Pattern Recognition*, Volume 2 (pp. 366–373). 27 June–2 July, Washington, DC.
- Christ, R. D., and R. L. Wernli. 2013. *The ROV Manual: A User Guide to Remotely Operated Vehicles*. Butterworth-Heinemann, Oxford, United Kingdom.
- Ciccimaro, D., and M. West. 1998. "An Automated Security Response Robot," *Robotics and Machine Perception* (August), vol. 7, no. 2, p. 9.
- Ciccimaro, D. A., H. R. Everett, G. A. Gilbreath, and T. T. Tran. 1998. "An Automated Security Response Robot." *Proceedings of SPIE 3525: Mobile Robots XIII and Intelligent Transportation Systems* (pp. 50–61). 1–5 November, Boston, MA.
- CMU. 2016a. "Tactical Mobile Robotics." Carnegie Mellon University. Available online at https://www.ri.cmu.edu/research_project_detail.html?project_id=267&menu_id=261. Accessed 26 January.
- CMU. 2016b. "Waypoint Navigation Design." Carnegie Mellon University. Available online at <http://www.cs.cmu.edu/~tmr/waypoint/design.html>. Accessed 27 January.
- Collins, T. R., R. C. Arkin, M. J. Cramer, and Y. Endo. 2000. "Field Results of Tactical Mobile Robot Missions." Available online at http://www.cc.gatech.edu/ai/robot-lab/tmr/field_results.pdf. *Unmanned Systems 2000*. 11–13 July, Orlando, FL.
- Collins, R. T., and Y. Tsin. 1999. "Calibration of an Outdoor Active Camera System." *Proceedings of IEEE Computer Society Conference on Computer Vision and Pattern Recognition (CVPR 99)* (pp. 528–534). June 23–25, Fort Collins, CO.
- Cory, P., H. R. Everett, and T. Heath-Pastore. 1998. "Radar-Based Intruder Detection for a Robotic Security System." *Proceedings of SPIE 3525: Mobile Robots XIII and Intelligent Transportation Systems* (pp. 62–72). 1–5 November, Boston, MA.
- Curd, K. M. 2009. "DDR&E's J. M. 'Raleigh' Durham Visits SSC Pacific," *Robotics Update*, vol. 9, no. 2 (Fall).
- DARPA. 1986. "Strategic Computing Program Second Annual Report (February)." Defense Advanced Research Projects Agency, Arlington, VA.
- Davis, B. 2011. "Where We've Been: The ROBART Series." Association of Unmanned Vehicle Systems International (pp. 51–52). Washington DC.
- Dahmann, J., G. Rebovich, J. Lane, R. Lowry, and K. Baldwin. 2011. "An Implementer's View of Systems Engineering for Systems of Systems." *IEEE International Systems Conference*, 4–7 April, Montreal, QC, Canada.
- DeBolt, C., C. O'Donnell, C. Freed, and T. Nguyen. 1997. "The BUGS 'Basic UXO Gathering System' Project for UXO Clearance and Mine Countermeasures." *Proceedings: 1997 IEEE Conference on Robotics and Automation* (pp. 329–334), 20–25 April, Albuquerque, NM.
- Del Giorno, M. 2015 "Scanned the Sensor." e-mail correspondence, 8 December.
- Delphi. 2015. "Delphi Electronically Scanning Radar." DESen 120180. Available online at <http://delphi.com/docs/default-source/old-delphi-files/b87cda8b-468d-4f8e-a7a8-836c370fc2c2-pdf>. Accessed 18 August 2015.
- Diffrient, N., A. Tilley, and J. Bardagjy. 1974. *Humanscale 1/2/3*. MIT Press, Cambridge, MA.
- Dziak, R. P., C. G. Fox, R. W. Embley, J. E. Lupton, G. C. Johnson, W. W. Chadwick, and R. A. Kosk. 1996. "Detection of and Response to a Probable Volcanogenic T-wave Event Swarm on the Western Blanco Transform Fault Zone," *Geography Research Letters*, vol. 23, pp. 873–876.
- Dlagnekov, L. 2005 "Video-Based Car Surveillance: License Plate, Make, and Model Recognition." Master's thesis. University of California, San Diego, San Diego, CA.
- Dombkins, D. 2007. *Complex Project Management*, Booksurge Publishing, Charleston, SC.
- DoN. 2012. "Department of the Navy Objectives for FY 2012 and Beyond." Available online at http://www.public.navy.mil/navsafecen/Documents/DON_Obj_FY12_and_Beyond.pdf.

- DoN. 2015. "Department of the Navy Objectives for FY 2012 and Beyond." Available online at http://www.public.navy.mil/navsafecen/Documents/DON_Obj_FY15_and_Beyond.pdf.
- Dove, R., B. Schindel, and C. Scrapper. 2016. "Agile Systems Engineering Process features Collective Culture, Consciousness, and Conscious at SSC Pacific Unmanned Systems Group." *26th Annual INCOSE International Symposium*, 18–21 July, Edinburgh, Scotland.
- Eng, K. Y., T. M. Lu, and T. P. Bradley. 1992. "Product/Barrier Assessment Development for the Mobile Detection Assessment Response System Program: Phase I." Technical Memo NDTM 92002 (May), FSN 92004, U.S. Army Armament Research Development and Engineering Center, Picatinny Arsenal, NJ.
- Everett, H. R. 1982. "A Microprocessor Controlled Autonomous Sentry Robot." Master's thesis (October). Defense Technical Information Center (DTIC) ADA125239. Naval Postgraduate School, Monterey, CA.
- Everett, H. R. 1984. "NAVSEA Integrated Robotics Program: Annual Report: FY-84." NAVSEA Technical Report No. 450-90G-TR-0002 (December). Naval Sea Systems Command, Washington, DC.
- Everett, H. R. 1985a. "Naval Sea Systems Command Integrated Robotics Program: Annual Report, FY-85." NAVSEA Technical Report No. 450-90G-TR-0003 (December). Naval Sea Systems Command, Washington, DC. Available online at <http://www.public.navy.mil/spawar/Pacific/Robotics/Documents/Publications/1985/NAVSEA%20ROBOTICS.pdf>. Accessed March 24, 2016.
- Everett, H. R. 1985b. "Robotics Technology: Areas of Needed Research and Development." Ser. 90G/119 (6 September), White paper presented to the Office of Naval Research and Office of Naval Technology. Washington, DC.
- Everett, H. R. 1985c. "Robotics in the Navy: Industrial Applications," *Robotics Age* (November), pp. 6–11.
- Everett, H. R. 1985d. "A Second Generation Autonomous Sentry Robot," *Robotics Age* (April), pp. 29–32.
- Everett, H. R. 1985e. "A Multi-Element Ultrasonic Ranging Array," *Robotics Age* (July), pp. 13–20.
- Everett, H. R. 2003. "Robotic Security Systems," *IEEE Instrumentation and Measurement Magazine* (December), vol. 6, No. 4, pp. 30–34.
- Everett, H. R. 2005. "Robart I: In Retrospect." SSC Pacific Technical Document 3199 (December). Space and Naval Warfare Systems Center San Diego, San Diego, CA. Available online at Defense Technical Information Center (DTIC) ADA487366: <http://www.dtic.mil/get-tr-doc/pdf?AD=ADA487366>. Accessed March 30 2016.
- Everett, H. R. 1995a. *Sensors for Mobile Robots: Theory and Application*, A. K. Peters, Ltd., Wellesley, MA.
- Everett, H. R. 1995b. "Understanding Ultrasonic Ranging Sensors," *The Robotics Practitioner* (Fall).
- Everett, H. R. 1996a. "Autonomous Navigation on a Shoestring Budget," *The Robotics Practitioner* (Winter), pp. 15–23.
- Everett, H. R. 1996b. "Representational World Modeling," *The Robotics Practitioner* (Spring), pp. 31–38.
- Everett, H. R. 1997. "Bulletized Rational for Not Competing the MRHA," e-mail attachment to LtCol Bruce Swagler, PM-PSE, Fort Belvoir, VA, 24 October, 1997.
- Everett, H. R. 1998. "MDARS-I EUA Demonstration Plan," prepared 27 February for PM-PSE, Fort Belvoir, VA.
- Everett, H. R. 2015. "Unmanned Systems of World Wars I & II." MIT Press, Wellesley, MA.
- Everett, H. R., and G. L. Bianchini. 1987. "ROBART II: An Intelligent Security Robot." *U.S. Army Training and Doctrine Command, Artificial Intelligence and Robotics Symposium*, Norfolk, VA.

- Everett, H. R., and A. M. Flynn. 1986. "A Programmable Near-Infrared Proximity Detector for Mobile Robot Navigation." *Proceedings of SPIE 00727: Mobile Robots I*. 26–31 October, Cambridge, MA.
- Everett, H. R., D. W. Gage, G. A. Gilbreath, R. T. Laird, and R. P. Smurlo. 1994. "Real-world Issues in Warehouse Navigation." *Proceedings of SPIEL 2352: Mobile Robots IX* (pp. 249–259). 2–4 November, Boston, MA.
- Everett, H. R., and D. W. Gage. 1995. "Navigational Referencing Techniques for Real-World Environments." *Proceedings of SPIE 2591: Mobile Robots X* (pp. 43–54). 23–24 October, Philadelphia, PA.
- Everett, H. R., and D. W. Gage. 1996. "A Third Generation Security Robot." *Proceedings of SPIE 2903: Mobile Robot and Automated Vehicle Control Systems* (pp. 118–126). 20–21 November, Boston, MA.
- Everett, H. R., and G. A. Gilbreath. 1989. "ROBART II: A Robotic Security Testbed," NOSC Technical Document 1450 (January), Naval Oceans Systems Center, San Diego, CA.
- Everett, H. R., and G. A. Gilbreath. 1998. "A Supervised Autonomous Security Robot," *Robotics and Autonomous Systems*, vol.4, no. 3, pp. 209–232.
- Everett, H. R., G. A. Gilbreath, and S. L. Alderson. 1988. "Intelligent Security Assessment for a Mobile Sentry Robot." *Proceedings of the 29th Annual Meeting, Institute for Nuclear Materials Management*. 26–29 June, Las Vegas, NV.
- Everett, H. R., G. A. Gilbreath, and G. L. Bianchini. 1988. "ROBART II: An Autonomous Sentry Robot." NOSC Technical Document 1230 (March). Naval Ocean Systems Center, San Diego, CA.
- Everett, H. R., G. A. Gilbreath, T. A. Heath, and R. T. Laird. 1993. "Coordinated Control of Multiple Security Robots." *Proceedings of SPIE 2058: Mobile Robots VIII* (pp. 292–305). 9–10 September. Cambridge, MA.
- Everett, H. R., G. A. Gilbreath, and T. T. Tran. 1990. "Modeling the Environment of a Mobile Security Robot." NOSC Technical Document 1835 (August). Naval Ocean Systems Center, San Diego, CA.
- Everett, H. R., T. A. Heath-Pastore, S. P. Hower. 1994. "Host Architecture for Coordinated Control of Multiple Autonomous Platforms." ISRAM 94: Fifth International Symposium on Robotics and Manufacturing. 14–18 August, Maui, HI.
- Everett, H. R., R. Inderieden, D. Jaffee, and R. Walker. 1999. "RoboGuards Nab Bads, Track Tagged Goods," *ID Systems* (March), vol. 19, no. 3, pp. 18–27.
- Everett, H. R., R. T. Laird, D. M. Carroll, G. A. Gilbreath, T. A. Heath-Pastore, R. S. Inderieden, T. Tran, K. J. Grant, and D. M. Jaffee. 2000. "Multiple Resource Host Architecture (MRHA) for the Mobile Detection Assessment Response System (MDARS)." SSC San Diego Technical Document 3026, Revision A (September). Available online at Defense Technical Information Center (DTIC) ADA422131: <http://www.dtic.mil/dtic/tr/fulltext/u2/a422131.pdf>. Accessed 28 March 2015.
- Everett, H. R., E. B. Pacis, G. Kogurt, N. Farrington, and S. Khurana. 2004. "Towards a Warfighter's Associate: Eliminating the Operator Control Unit." *SPIE Proceedings 5609: Mobile Robots XVII*. 26–28 October, Philadelphia, PA. Available online at <http://www.public.navy.mil/spawar/pacific/robotics/pages/publications.aspx>. Accessed 28 March 2016.
- Exponent. 2016. "MARCbot." Exponent Engineering and Scientific Consulting. Available online at http://www.exponent.com/marcbot_product/. Accessed 20 January, 2016.
- Farrington, N., H. G. Nguyen, and N. Pezeshkian. 2004. "Intelligent Behaviors for a Convoy of Indoor Mobile Robots Operating in Unknown Environments." *Proceedings of SPIE 5609: Mobile Robots XVII*. 26–28 October, Philadelphia, PA.

- Finkelstein, R. 2010. "Military Robotics: Malignant Machines or the Path to Peace?" Available online at <http://www.roboticstechnologyinc.com/images/upload/file/Presentation%20Military%20Robotics%20Overview%20Jan%202010.pdf>. Accessed 28 March 2016.
- Flynn, A. M. 1985. "Redundant Sensors for Mobile Robot Navigation." Master's thesis (October). Massachusetts Institute of Technology, Cambridge, MA. Available online at Defense Technical Information Center (DTIC) ADA161087: www.dtic.mil/dtic/tr/fulltext/u2/a161087.pdf. Accessed 31 March 2016.
- Fowler, E. B. 1984. "NAVSEA Policy Relative to Intelligent Machine Automation and Robotics." Memorandum (11 May), Ser. 90G/63. Commander, Naval Sea Systems Command (NAVSEA), Washington, DC.
- Gage, D. W., and S. P. Hower. 1994. "The MDARS Multiple Robot Host Architecture." *Proceedings of AUVS-94, 21st Annual Technical Symposium and Exhibition of the Association for Unmanned Vehicle Systems* (pp 133–136). 23–25 May, Detroit, MI.
- Gage, D. W. 1995a. "Many-Robot MCM Search Systems," *Autonomous Vehicles in Mine Countermeasures Symposium* (pp. 9–55 to 9-63). 4–7 April, Monterey, CA.
- Gage, D. W. 1995b. "UGV History 101: A Brief History of Unmanned Ground Vehicle (UGV) Development Efforts," *Unmanned Systems Magazine* (Summer), vol. 13, no. 3.
- Gage, D. W. 1997. "Network Protocols for Mobile Robot Systems." *SPIE Proceedings 3210: Mobile Robots XII*. 14–17 October, Pittsburgh, PA.
- Gage, D. W., W. D. Bryan, and H. G. Nguyen. 1998. "Internetting Tactical Security Sensor Systems." *SPIE Proceedings 3393: Digitization of the Battlespace*. 15–17 April, Orlando, FL.
- Gage, D. W. 2000. "Current Thrusts in Ground Robotics: Programs, Systems, Technologies, Issues." *Proceedings of the Fourth International Symposium on Technology and the Mine Problem*. 12–16 March, Monterey, CA.
- Gilbreath, G. A., and H. R. Everett. 1988. "Path Planning and Collision Avoidance for an Indoor Security Robot." *Proceedings of SPIE 1007: Mobile Robots III*. 10–11 November, Cambridge, MA.
- Gilbreath, G.A., D. A. Ciccimaro, and H. R. Everett. 2000. "An Advanced Telereflexive Tactical Response Robot." *Proceedings, Workshop 7: Vehicle Teleoperation Interfaces*. IEEE International Conference on Robotics and Automation (ICRA2000). 28 April, San Francisco, CA.
- Gillingham, K. K., and J. W. Wolfe. 1986. "Spacial Orientation in Flight." USAFSAM-TR-85-31 (December). USAF School of Aerospace Medicine, Brooks Air Force Base, TX.
- Gregory, J. D., R. Lujan, D. Haley, and W. Hamel. 2001. "Robotics and Intelligent Machines: A DOE Critical Technology Roadmap." WM'01 Conference. 25 February—1 March, Tucson, AZ. Available online at <http://web.ornl.gov/~webworks/cpr/y2001/pres/109760.pdf>. Accessed 28 March 2016.
- Harmon, S. Y. 1982. "Ground Surveillance Robot (GSR): The Beginning of Robotics for the US Marine Corps." NOSC Technical Report 788. Naval Ocean Systems Center, San Diego, CA.
- Harmon, S. Y. 1984. "USMC Ground Surveillance Robot: A Testbed for Autonomous Vehicle Research." *Proceedings of the 4th UAH/UAB Robotics Conference*. 24–26 April, Huntsville, AL.
- Harmon, S. Y. 1986. "USMC Ground Surveillance Robot (GSR): Lessons Learned." *Proceedings of SPIE 0727: Mobile Robots I* (pp 336–343). 28 October, Cambridge, MA.
- Harmon, S. Y. 1987a. "The Ground Surveillance Robot (GDR): An Autonomous Vehicle Designed to Transit Unknown Terrain," *IEEE Journal of Robotics and Automation* (June), vol. RA-3, no. 3, pp. 266–279.

- Harmon, S. Y. 1987b. "Implementation of Complex Robotic Subsystems on Distributed Computing Resources." In *Machine Intelligence and Knowledge Engineering for Robotic Applications*, pp. 407–435, A. K. C. Wong & A. Pugh, Eds. NATO ASI Series, Volume F33, Springer-Verlag, Berlin, Germany.
- Harmon, S. Y., W. A. Aviles, and D. W. Gage. 1996. "A Technique for Coordinating Autonomous Robots." *Proceedings of the IEEE International Conference on Robotics and Automation* (pp. 2029–2034), 7–10 April, San Francisco, CA.
- Harmon, S. Y., G. Bianchini, and B. Pinz. 1986. "Sensor Data Fusion on an Autonomous Mobile Robot through a Distributed Blackboard." *Proceedings of the IEEE International Conference on Robotics and Automation* (pp. 1449–1454). 7–10 April, San Francisco, CA.
- Harmon, S. Y., and D. W. Gage, W. Aviles, and G. Bianchini. 1984. "Coordination of Intelligent Systems in Complex Robots." *Proceedings of the 1st IEEE Conference on Artificial Intelligence Applications* (pp. 64–69). December, Denver, CO.
- Harmon, S. Y., and D. W. Gage. 1984. "Current Technical Research Issues of Autonomous Robots Employed in Combat." *Proceedings of 1984 EASCON: 17th Annual Electronics and Aerospace Conference* (pp. 215–219). 11–13 September, Washington, DC. Available online at <http://www.public.navy.mil/spawar/Pacific/Robotics/Documents/Publications/1984/eascon84.pdf> Accessed 28 March 2016.
- Hart, A., N. Pezeshkian, and H. Nguyen. 2012. "Mesh Networking Optimized for Robotic Teleoperation." *Proceedings of SPIE 8387: Unmanned Systems Technology XIV*. 25–27 April, Baltimore, MD.
- Heath-Pastore, T.A., and H. R. Everett. 1994. "Coordinated Control of Interior and Exterior Autonomous Platforms." ISRAM 94: Fifth International Symposium on Robotics and Manufacturing, 14–18 August, Maui, HI.
- Helmick, D., S. Roumeliotis, M. McHenry, and L. Matthies. 2002. "Multi-Sensor, High Speed Autonomous Stair Climbing." *Proceedings of the IEEE/RSJ Conference on Intelligent Robots and Systems (IROS), Volume 1* (pp. 733–742). 30 September—4 October, EPFL Lausanne, Switzerland.
- Hightower, J. D., and R. L. Sciple. 1978. "Operational Experience with the Swath Ship SSP Kaimalino." AIAA/SNAME Advanced Marine Vehicle Conference, Paper No. 78/741. 17–19 April, San Diego, CA.
- Hoffman, R. T. 1991. "Advanced Tethered Vehicle, Design and Description." *Proceedings of Association of Unmanned Vehicle Systems*. Defense Technical Information Center (DTIC) AD0A245254 (August).
- Holland, J., H. R. Everett, and G. A. Gilbreath. 1990. "Hybrid Navigational Control Scheme." *Proceedings of SPIE 1388: Mobile Robots V* (pp. 291–298). 8–9 November, Boston, MA.
- Holland, J. M., A. Martin, R. P. Smurlo, and H. R. Everett. 1995. "MDARS Interior Platform." *Proceedings Manual: Association of Unmanned Vehicle Systems 22nd Annual Symposium and Exhibition (AUVS '95)*. 10–12 July, Washington, DC.
- Hughes, T. W., W. A. Aviles, H. R. Everett, A. Y. Umeda, S. W. Martin, A. H. Koyamatsu, M. R. Solorzano, R. T. Laird, and S. P. McArthur. 1990. "Issues in Mobile Robotics: Unmanned Ground Vehicle Program Teleoperated Vehicle." *Proceedings of SPIE 1388: Mobile Robots V* (pp. 587–597). 8–9 November, Boston, MA.
- Huntsberger, D. V. 1967. *Elements of Statistical Inference*. Allyn and Bacon, Inc., Boston, MA.
- Inderieden, R. S., H. R. Everett, T. A. Heath-Pastore, and R. P. Smurlo. 1995. "Overview of the Mobile Detection Assessment and Response System." *DND/CSA Robotics and KBS Workshop*. October, St. Hubert, Quebec, Canada.

- Johnson, J. 1958. "Analysis of Image Forming Systems." *Proceedings of the Image Intensifier Symposium*. Defense Technical Information Center (DTIC) AD220160. U.S. Army Engineer Research and Development Laboratories. 6–7 October, Fort Belvoir, VA.
- JRP. 2002. "Joint Robotics Program Master Plan: FY02." OUSD (AT&L) Defense Systems/Land Warfare and Munitions, Washington, DC.
- JRP. 2004. "Joint Robotics Program Plan: Out Front in Harm's Way." OUSD (AT&L) Defense Systems/Land Warfare and Munitions, Washington, DC.
- Kadonoff, M. 1994. Chief Engineer, Denning Mobile Robots, conversation with Bart Everett regarding earlier Denning *Sentry* development.
- Katevos, N., Ed. 2001. "Robotic Assistance for Hospital Fetch and Carry Services." In *Mobile Robotics in Healthcare*, pp. 76–77. Assistive Technology Research Series. IOS Press, Amsterdam, The Netherlands.
- Kogut, G., and L. Drymon. 2004. "A Vision System for an Unmanned Gun Pod." *Proceedings of SPIE 5608: Intelligent Robots and Computer Vision XXII*. 25–27 October, Philadelphia, PA.
- Kogut, G. T., F. Birchmore, E. B. Pacis, G. Ahuja, B. Sights, and H. R. Everett. 2006. "Using Advanced Computer Vision Algorithms on Small Mobile Robots." *Proceedings of SPIE 6230: Unmanned Systems Technology VIII. Defense & Security Symposium*. 17–20 April, Orlando, FL.
- Krotkov, E., and J. Blich. 1999. "The Defense Advanced Research Projects Agency (DARPA) Tactical Mobile Robotics Program," *International Journal of Robotics Research* (18 July), vol. 18, no. 7, pp. 769–776.
- Laird, R. T., and H. R. Everett. 1990. "Reflexive Teleoperated Control." *Proceedings Manual: Association For Unmanned Vehicle Systems 17th Annual Technical Symposium and Exhibition (AUVS '90)* (pp. 280–292). 30 July–1 August, Dayton, OH.
- Laird, R. T., R. P. Smurlo, and S. R. Timmer. "Development of a Modular Robotic Architecture," NOSC Technical Document 2171 (September). Naval Ocean Systems Center, San Diego, CA.
- Laird, R. T., H. R. Everett, and G. A. Gilbreath. 1993. "A Host Architecture for Multiple Robot Control." *Proceeding of the American Nuclear Society (ANS) Fifth Topical Meeting on Robotics and Remote Handling* (pp. 531–538), 23–27 April, Knoxville, TN.
- Laird, R. T. 1993. "Software Test Description for the Link Server CSCI of the Mobile Detection Assessment Response System." MDARS-LINKSERV-STD-CAT-ROC1 (6 July). Adaptive Systems Branch (Code 531), Naval Command and Control and Ocean Systems Center (NCCOSC), San Diego, CA.
- Laird, R. T., G. A. Gilbreath, T. A. Heath-Pastore, H. R. Everett, R. S. Inderieden, and K. Grant. 1995. "MDARS Multiple Robot Host Architecture." *Proceedings Manual: Association of Unmanned Vehicle Systems 22nd Annual Technical Symposium and Exhibition (AUVS '95)*. 10–12 July, Washington, DC.
- Laird, R. T., M. Bruch, M. West, D. Ciccimaro, and H. R. Everett. 2000. "Issues in Vehicle Teleoperation for Tunnel and Sewer Reconnaissance." *Proceedings of the IEEE International Conference on Robotics and Automation (ICRA 2000)*. 24–28 April, San Francisco, CA. Available online at Defense Technical Information Center (DTIC) ADA422071.
- Lang, T. G., and J. E. Sloggett. 1985. "SWATH Developments and Performance Comparisons with other Craft." *International Conference on SWATH Ships and Advanced Multi-Hull Vessels*. 17–19 April, London, United Kingdom.
- Larson, J., J. Ebken, and M. H. Bruch. 2006. "Autonomous Navigation and Obstacle Avoidance for Unmanned Surface Vehicles." *SPIE Proceedings 6230: Unmanned Systems Technology VIII. Defense Security Symposium*. 17–20 April, Orlando, FL.
- Larson, J., M. Bruch, R. Halterman, J. Rogers, and R. Webster. 2007. "Advances in Autonomous Obstacle Avoidance for Unmanned Surface Vehicles." *Proceedings of the AUVSI Unmanned Systems North America*. 6–9 August, Washington, DC.

- Larson, J., B. Okorn, T. Pastore, D. Hooper, and J. Edwards. 2014. "Counter Tunnel Exploration, Mapping, and Localization with an Unmanned Ground Vehicle." *SPIE Proceedings 9084: Unmanned Systems Technology XVI*. 6–8 May, Baltimore, MD.
- Larson, J., T. A. Pastore, D. Hooper, B. Okorn, J. Edwards, and B. Skibba. 2015. Counter Tunnel Project Final Report. SSC Pacific Technical Report 2071. Space and Naval Warfare Systems Center Pacific, San Diego, CA.
- Lash, C. 2006. "Robots Built in W.Va. Going to Iraq to Detonate Bombs," *Pittsburgh Post-Gazette* (21 April). Available online at <http://www.post-gazette.com/news/world/2006/04/21/Robots-built-in-W-Va-going-to-Iraq-to-detonate-bombs/stories/200604210224>, Accessed 29 March 2016.
- Lee, C. Y. 1961. "An Algorithm for Path Connections and its Applications," *IRE Transactions in Electronic Computing* (September), vol. EC-10, pp. 346–365.
- Lemaire, I. P. 1988. "NOSC and Remotely Operated Vehicles (ROVs) and Autonomous Unmanned Vehicles (AUVs)." NOSC Technical Document 1448 (November). Defense Technical Information Center (DTIC) AD-A203356. Naval Ocean Systems Center, San Diego, CA.
- Martin, B., and D. Bryan. 1995. "Low-Cost Miniature Interface and Control Systems for Smart Sensors, Tactical Radios, and Computer Networks." IEEE Military Communications Conference (MILCOM 95). 6–8 November, San Diego, CA.
- Martinson, S. P. 1988. "An Inexpensive Real-Time Flight Simulator for the United States Marine Corps' Airborned Remotely Operated Device," Master's thesis (June). Naval Postgraduate School, Monterey, CA, Available online at <http://calhoun.nps.edu/bitstream/handle/10945/23268/inexpensiverealt00mart.pdf?sequence=1>. Accessed 31 March 2016.
- Matthies, L., Y. Xiong, R. Hogg, D. Zhu, A. Rankin, B. Kennedy, M. Hebert, R. Maclachlan, C. Won, T. Frost, G. Sukhatme, M. McHenry, and S. Goldberg. 2000. "A Portable, Autonomous, Urban Reconnaissance Robot." The 6th International Conference on Intelligent Autonomous Systems, 25–27 July, Venice, Italy.
- McGovern, D. E. 1990. "Experiences and Results in Teleoperation of Land Vehicles." Sandia Report SAND90-0299 (April). Albuquerque, NM.
- Metz, C. D., H. R. Everett, and S. Myers. 1992. "Recent Developments in Tactical Unmanned Ground Vehicles." *Proceedings Manual: Association of Unmanned Vehicle Systems 22nd Annual Symposium and Exhibition (AUVS-92)*. 22–24 June. Huntsville, AL.
- Miller, I., and J. E. Freund. 1977. *Probability and Statistics for Engineers*. Prentice-Hall, Inc., Englewood Cliffs, NJ.
- Morinaga, W. S., and R. T. Hoffman. 1991. "Advanced Tethered Vehicle," *Oceans '91*, vol. 3. Defense Technical Information Center (DTIC) AD-A244885.
- Mullens, K. D. 2001. "SSC San Diego Robots Assist New York City Rescue Effort," *Robotics Update*, vol. 1, no. 2 (31 December). Adaptive Systems Branch (Code D371), Space and Naval Warfare Systems Center San Diego, San Diego, CA.
- Mullens, K. D. 2002a "Robots Sent to Assist EOD Efforts for Operation Enduring Freedom," *Robotics Update* (22 April), vol. 2, no. 1. Robotic Systems Branch (Code 2371), Space and Naval Warfare Systems Center San Diego, San Diego, CA.
- Mullens, K. D. 2002b. "Allied Aerospace's UAV Launched from MDARS-E Platform," *Robotics Update* (22 April), Vol. 2, No. 1. Robotic Systems Branch (Code 2371), Space and Naval Warfare Systems Center San Diego, San Diego, CA.
- Mullens, K. D. 2002c. "Free-Flight Launch of iStar from MDARS-E," *Robotics Update* (19 April) vol. 2, no. 2. Robotic Systems Branch (Code 2371), Space and Naval Warfare Systems Center San Diego, San Diego, CA.

- Mullens, K. D. 2003a. "Chem/Rad Sensor Payload Achieves Army LOE Objective," *Robotics Update* (21 April), vol. 3, no. 1. Robotic Systems Branch (Code 2371), Space and Naval Warfare Systems Center San Diego, San Diego, CA.
- Mullens, K. D. 2003b. "U.S. Navy Shows High-Level Interest in Robotic Systems," *Robotics Update* (15 August), vol. 3, no. 2. Robotic Systems Branch (Code 2371), Space and Naval Warfare Systems Center San Diego, San Diego, CA.
- Mullens, K. D., E. B. Pacis, S. B. Stancliff, A. B. Burmeister, T. A. Denewiler, M. H. Bruch, and H. R. Everett. 2003. "An Automated UAV Mission System," *Proceedings of the AUVSI Unmanned Systems in International Security 2003* (USIS 03). 9–12 September, London, United Kingdom.
- Mullens, K., A. Burmeister, M. Wills, N. Stroumtsos, T. Denewiler, K. Thomas, and S. Stancliff. 2004. "Automated Launch, Recovery, and Refueling for Small Unmanned Aerial Vehicles." *SPIE Proceedings 5609: Mobile Robots XVII*. 26–28 October, Philadelphia, PA.
- Mullens, K. D. 2005. *Robotics Update*, vol. 5, no. 1 (Spring). Unmanned Systems Branch (Code 2371), Space and Naval Warfare Systems Center San Diego, San Diego, CA
- Murphy, D. W. 1991. "Advances and Experience with Teleoperated Systems Incorporating Remote Presence." *Proceedings of U.S.-Japan Cooperative Program in Natural Resources (UJNR) Meeting*. 10 May, Tokyo, Japan.
- Murphy, D. W. 1994. "The Air-Mobile Ground Security and Surveillance System (AMGSSS)." *Proceedings of the 10th Annual American Defense Preparedness Association (ADPA) Security Technology Symposium* (pp. 129–134). 20–23 June.
- Murphy, D. W. 1994. "Advantages of Teleoperated Undersea Vehicles," *Proceedings of the 19th Joint Meeting of the UJNR Marine Facilities Panel* (pp. 379–385), May, Tokyo, Japan.
- Murphy, D. W. and J. P. Bott. 1995. "The Air Mobile Ground Security Surveillance System (AMGSSS)," *Unmanned Systems Magazine* (Summer), vol. 13, no. 3.
- Murphy, D. W., and J. P. Bott. "On the Lookout: The Air Mobile Ground Security and Surveillance System (AMGSSS) Has Arrived," *Unmanned Systems* (Fall), vol. 13, no. 4.
- Murphy, D.W., J. P. Bott, J. P. Cycon, W. D. Bryan, J. J. L. Coleman, D. W. Gage, W. C. Marsh, B. F. Martin, H. G. Nguyen, and R. Schneider. 1996. "Air-Mobile Ground Security and Surveillance System (AMGSSS) Project Summary Report." NRaD Technical Document 2914 (September). Naval Command and Control Ocean and Surveillance Center RDT&E Division, San Diego, CA.
- Murphy, D. W., J. P. Bott, W. D. Bryan, J. L. Coleman, D. W. Gage, H. G. Nguyen, and M. P. Cheatham. 1997. "MSSMP: No Place to Hide." *Proceedings Manual: Annual Symposium and Exhibition, Association of Unmanned Vehicle Systems (AUVSI'97)*, 3–6 June, Baltimore, MD.
- Myers, S. D. 1991. "Surrogate Teleoperated Vehicle." *Proceedings of the IEEE National Telesystems Conference (NTC '91), Volume 1* (pp. 315–320). 26–27 March, Atlanta, GA.
- Myers, S. D. 1994. "Design of an Autonomous Exterior Security Robot." NASA Conference on Intelligent Robotics in Field, Factory, Service, and Space. Publication 3251, Volume 1 (pp. 82–87). 21–24 March, Houston, TX.
- Myers, S. D. 1995. "The MDARS Exterior Platform." *Proceedings Manual: 22nd Annual Symposium and Exhibition, Association of Unmanned Vehicle Systems (AUVS '95)*. 10–12 July, Washington, DC.
- Nakagawa, A. T., and D. C. Smith. 1980. "A Report on Two Fiber-Optic-Tethered Underwater Vehicles." *IEEE Oceans '80*. 8–10 September, Seattle, WA.
- Nayar, S. K. 1997. "Catadioptric Omnidirectional Camera." *Proceedings of the IEEE Computer Society Conference on Computer Vision and Pattern Recognition* (pp. 482–488). 17–19 June, San Juan, Puerto Rico.

- Newton, J., Ed. 1998. "MDARS-I Security Robots Up and Running in Field Installation," *OutLook* (20 March), Space and Naval Warfare Systems Center San Diego, San Diego, CA.
- Newton, J., Ed. 2001. "Robotics Group Assists New York, Rescue Operations," *OutLook* (12 October). Space and Naval Warfare Systems Center San Diego, San Diego, CA.
- Newton, J., Ed. 2002. "Secretary of Defense Donald Rumsfeld Visits Center," *OutLook* (13 September). Space and Naval Warfare Systems Center San Diego, San Diego, CA.
- Newton, J., Ed. 2004. "Networked-Integrated Remotely Operated Weapon System (NROWS) Upgrades Demonstrated," *OutLook* 19 November). Space and Naval Warfare Systems Center San Diego, San Diego, CA.
- Newton, J. 2006. "Summer Interns Complete Prototype Refueling Systems for Small UAVs," *OutLook* (10 February). Space and Naval Warfare Systems Center San Diego, San Diego, CA.
- Newton, J. 2006. "ROBART III is in the News," *OutLook* (24 February). Space and Naval Warfare Systems Center San Diego, San Diego, CA.
- Nguyen, H. G., W. G. Marsh, and W. D. Bryan. 1996. "Virtual Systems: Aspects of the Air-Mobile Ground Security and Surveillance System Prototype," *Unmanned Systems* (Winter), vol. 14, no. 1.
- Nguyen, H. G., H. R. Everett, N. Manouk, and A. Verma. 2002. "Autonomous Mobile Communication Relays." *Proceedings of SPIE 4715: Unmanned Ground Vehicle Technology IV*. 1–5 April, Orlando, FL.
- Nguyen, H. G., N. Pezeshkian, M. Raymond, A. Gupta, and J. M. Spector. 2003. "Autonomous Communication Relays for Tactical Robots." IEEE 11th International Conference on Advanced Robotics (ICAR 2003). 30 June–3 July, Coimbra, Portugal.
- Nguyen; H., G., G. Kogut, R. Barua, A. Burmeister, N. Pezeshkian, D. Powell, N. M. Farrington, M. Wimmer, B. Cicchetto, C. Heng, and V. Ramirez. 2004. "A Segway RMP-Based Robotic Transport System." *SPIE Proceedings 5609: Mobile Robots XVII*, October 27–28. Philadelphia, PA.
- Nguyen, H. G., N. Pezeshkian, A. Gupta, and N. M. Farrington. 2004. "Maintaining Communication Link for a Robot Operating in a Hazardous Environment." *American Nuclear Society (ANS) 10th International Conference on Robotics and Remote Systems for Hazardous Environments*. 28–31 March, Gainesville, FL.
- Nguyen, H. G., and M. Baker. 2012. "Characteristics of a Maritime Interdiction Operations Unmanned Ground Vehicle." *Proceedings of SPIE 8387: Unmanned Systems Technology XIV*. 25–27 April, Baltimore, MD.
- Nguyen, H. G., N. Pezeshkian, K. Holz, A. Hart, M. Baker, and R. Fransham. 2012a. "Manually-Deployed Communication Relays (MDCR) Operator Manual for the iRobot/Boeing Mini-EOD Revision A." SSC Pacific Technical Document 3263 (30 May). Space and Naval Warfare Systems Center Pacific, San Diego, CA.
- Nguyen, H. G., N. Pezeshkian, K. Holz, A. Hart, M. Baker, and R. Fransham. 2012b. "Manually-Deployed Communication Relays (MDCR) Installation Manual for use with iRobot PackBot 510 and the iRobot/Boeing Mini-EOD (SUGV 310) Revision A." SSC Pacific Technical Document 3264 (30 May). Space and Naval Warfare Systems Center Pacific, San Diego, CA.
- Nguyen, H. G., N. Pezeshkian, K. Holz, A. Hart, M. Baker, and R. Fransham. 2012c. "Manually-Deployed Communication Relays (MDCR) Operator Manual for the iRobot PackBot 510 Revision A." SSC Pacific Technical Document 3265 (30 May). Space and Naval Warfare Systems Center Pacific, San Diego, CA.
- Nguyen, H., N. Pezeshkian, A. Hart, A. Burmeister, K. Holz, J. Neff, and L. Roth. 2013. "Evolution of a Radio Communication Relay System." *Proceedings of SPIE 8741: Unmanned Systems Technology XV*. 1–3 May, Baltimore, MD.

- Nguyen, H. G., and C. R. Castelli. 2014. "Development and Evaluation of the Stingray, an Amphibious Maritime Interdiction Operations Unmanned Ground Vehicle." *Proceedings of SPIE 9084: Unmanned Systems Technology XVI*. 6–8 May, Baltimore, MD.
- Nguyen, H. G., A. Nans, K. Talke, P. Candela, and H. R. Everett. 2015. "Automatic Behavior Sensing for a Bomb-Detecting Dog." *Proceedings of SPIE 9468: Unmanned Systems Technology XVII*. 21–23 April, Baltimore, MD.
- Nguyen, H. G. 2016. "The Pan-and-Tilt Unit." e-mail correspondence, 27 January.
- Ojeda, L., G. Reina, D. Cruz, and J. Borenstein. 2006. "The FLEXnav Precision Dead-reckoning System." *International Journal of Vehicle Autonomous Systems (IJVAS). Special Issue on Computational Intelligence and Its Applications to Mobile Robots and Autonomous Systems*, vol. 4, nos. 2–4, pp. 173–195.
- Ollis, M. 2011. "LongROAD: Fused Radar, Ladar, and Vision for Long-Range Obstacle Detection." Report No. W15QKN-09-RPP-0004, Topic 2.2 (April). Science Engineering and Technology (SET) Corporation. Arlington, VA. (U.S. Government Agencies only).
- Pacis, E. B., B. Sights, G. Ahuja, G. Kogut, H. R. Everett. 2006. "An Adaptive Localization System for Outdoor/Indoor Navigation for Autonomous Robots." *Proceedings of SPIE 6230: Unmanned Systems Technology VIII, Defense & Security Symposium*. 17–20 April, Orlando, FL.
- Pastore, T. H. 1994. "Improved Operator Awareness of Teleoperated Land Vehicle Attitude." NRaD Technical Report 1659 (June). Naval Command, Control and Ocean Surveillance Center (NCCOSC) RDT&E Division, San Diego, CA.
- Pepper, R. L., R. E. Cole, E. H. Spain, and J. E. Sigurdson. 1983 "Research Issues Involved In Applying Stereoscopic Television to Remotely Operated Vehicles." *Proceedings of SPIE 0402: Three-Dimensional Imaging Conference*. 18 April, Geneva, Switzerland.
- Pezeshkian, N., H. G. Nguyen, and A. Burmeister. 2007. "Unmanned Ground Vehicle Radio Relay Deployment System for Non-line-of-sight Operations." *Proceedings of the 13th IASTED International Conference on Robotics and Applications*. 29–31 August, Wuerzburg, Germany.
- Pezeshkian, N., H. G. Nguyen, A. B. Burmeister, K. F. Holz, and A. Hart. 2010a. "Automatic Payload Deployment System." *Proceedings of SPIE 7692: Unmanned Systems Technology XII*. 5–9 April, Orlando, FL.
- Pezeshkian, N., N. G. Nguyen, B. A. Burmeister, K. F. Holz, and A. Hart. 2010b. "A Modular Design Approach for the Automatic Payload Deployment System." *Proceedings of the AUVSI Unmanned Systems North America Conference*. August 24–27, Denver, CO.
- Pezeshkian, N., J. D. Neff, and A. Hart. 2012. "Link Quality Estimator for a Mobile Robot." *Proceedings of the 9th International Conference on Informatics in Control, Automation and Robotics (ICINCO)*. 28–31 July, Rome, Italy.
- Pransky, J. 1997. "Mobile Robots: Big Benefits for US Military," *Industrial Robot*, vol. 24, no. 2, pp. 126–130.
- REF (Rapid Equipping Force). 2015. "Ref History." U.S. Army. Available online at <http://www.ref.army.mil/refhistory.html>. Accessed 29 December 2015.
- Rona, P. A., D. R. Jackson, T. Wen, C. Jones, K. Mitsuzawa, K. G. Bemis, and J. G. Dworski. 1997. "Acoustic Mapping of Diffuse Flow at a Seafloor Hydrothermal Site: Monolith Vent, Juan de Fuca Ridge," *Geophysical Research Letters*, vol. 24, pp. 2351–2354.
- Rosheim, M. E. 1994. *Robot Evolution: The Development of Anthrobotics*. John Wiley & Sons, New York NY.
- Scraper, C. 2014. "Evolutionary System Engineering Model for Unmanned Systems." National Defense Industrial Association (NDIA) System of Systems System Engineering Committee Meeting (August).

- Scrapper, C., R. Halterman, and J. Dahmann. 2016. "An Implementor's View of the Evolutionary Systems Engineering for Autonomous Unmanned Systems." *Proceedings of the 10th Annual IEEE International Systems Conference*. 18–21 April, Orlando, FL.
- SEG. 2008. "Systems Engineering Guide for Systems of Systems." Version 1.0 (August). U.S. Department of Defense, Washington, DC.
- Smith, S. H. 1992. "MDARS Platform Computer." Army Contract No. DAAA21-91-C-0071 (15 November), S. H. Smith Associates, Montville, NJ.
- Smurlo, R. P., and H. R. Everett. 1992. "Intelligent Security Assessment for a Mobile Robot." *Proceedings of Sensors Exposition* (pp. 125–132). 29 September–1 October, Chicago, IL.
- Smurlo, R. P., and H. R. Everett. 1994. "Intelligent Sensor Fusion for a Mobile Security Robot," *Sensors* (March), pp. 18–28.
- Smurlo, R. P., R. T. Laird, H. R. Everett, R. S. Inderieden, S. Elaine, and D. M. Jaffee. 1995. "MDARS Product Assessment System." *Proceedings Manual: Association of Unmanned Vehicle Systems 22nd Annual Symposium and Exhibition (AUVS '95)*. 10–12 July, Washington, DC.
- Snavely, N., S. M. Seitz, and R. Szeliski. 2008. "Modeling the World from Internet Photo Collections," *International Journal of Computer Vision*, vol. 80, no. 2, pp. 189–210. Available online at <http://phototour.cs.washington.edu/>. Accessed 29 March 2016.
- Spackman, H. M. 1989. "Mathematical Analysis of Scissor Lifts." NOSC Technical Document 1550 (June). DTIC AD-A225220. Naval Ocean Systems Center, San Diego, CA.
- Spain, E. H. 1987. "Assessments of Maneuverability with the Teleoperated Vehicle." *Proceedings of the AUVS Symposium*. July, Washington, DC.
- Stevens, T. "Comments under 'Enter the BomBots' (Axe, 2006).
- Talkington, H. R. 1978. "Remotely Manned Undersea Work Systems at Naval Ocean Systems Center (NOSC)." NOSC Technical Report 237 (15 April). Naval Ocean Systems Center, San Diego, CA.
- TFT (Technical Feasibility Test). 1997. "Technical Feasibility Test Plan for the Mobile Detection Assessment Response System-Interior (MDARS-I)." Conducted by Aberdeen Test Center, 10–21 February 1997, at the Camp Elliott warehouse operated by the Naval Command Control and Ocean Surveillance Center, RDT&E Division, San Diego, CA.
- Thompson, B. G. 2006. "Detour Ahead: Critical Vulnerabilities in America's Rail and Mass Transit System." Report prepared by Democratic Staff of the Committee on Homeland Security. Released by Congressman Thompson (19 June 2006).
- Umeda, A. 2015. "Telepresence and Projects–Update." e-mail correspondence received 23 October.
- USR. 2007. "BomBot (MK 4 MOD) EOD Robot." Unmanned Systems Roadmap 2007–2032 (December), Appendix B, p. 128. Department of Defense, Washington, DC.
- USVMP, 2007. "The Navy Unmanned Surface Vehicle (USC) Master Plan (23 July)."
- UUVMP. 2004. "The Navy Unmanned Undersea Vehicle (UUV) Master Plan 9 November."
- Vickers, R. 2006. "Materials and Manufacturing Directorate Delivers Compact, Low-Cost Robot for Remote Improvised Explosive Device Neutralization," *Federal Laboratory Consortium Midwest Region Quarterly Newsletter* (Spring).
- Walter, W. G. 1953. *The Living Brain*. WW Norton & Co., New York, NY.
- Weiss, J. A., and R. K. Simmons. 1989. "TMAP–A Versatile Mobile Robot." *Proceedings of SPIE 1007 Mobile Robots III*. 7 November, Boston, MA.
- Wernli, R. L. 1979. "The Work Systems Package–Remote Work Experience." *Proceedings of Oceans '79* (pp.743–751). 17–19 September, San Diego, CA.
- Wernli, R. L. 1980. "Work Systems Package / Pontoon Impacement Vehicle Operational Testing at San Clemente Island." 1979, NOSC Technical Report 553 (June), Defense Technical Information Center (DTIC) AD-A093825. Naval Ocean Systems Center, San Diego, CA,

- Wikipedia. 2015. "Photosynth." Available online at <https://en.wikipedia.org/wiki/Photosynth>, Accessed 20 October 2015.
- Xiong, Y., and L. Matthies. 2000. "Vision-Guided Autonomous Stair Climbing." *IEEE International Conference on Robotics and Automation*. 24–28 April, San Francisco, CA..
- Yumori, I. R. 1998. "Advanced Tethered Vehicle Surface Handling System Test." NOSC Technical Report 1273 (December). Naval Ocean Systems Center, San Diego, CA.
- Zhang, Z. 2000. "A Flexible New Technique for Camera Calibration," *IEEE Transactions on Pattern Analysis and Machine Intelligence* (November), pp.1330–1334.

REPORT DOCUMENTATION PAGE

*Form Approved
OMB No. 0704-01-0188*

The public reporting burden for this collection of information is estimated to average 1 hour per response, including the time for reviewing instructions, searching existing data sources, gathering and maintaining the data needed, and completing and reviewing the collection of information. Send comments regarding this burden estimate or any other aspect of this collection of information, including suggestions for reducing the burden to Department of Defense, Washington Headquarters Services Directorate for Information Operations and Reports (0704-0188), 1215 Jefferson Davis Highway, Suite 1204, Arlington VA 22202-4302. Respondents should be aware that notwithstanding any other provision of law, no person shall be subject to any penalty for failing to comply with a collection of information if it does not display a currently valid OMB control number.

PLEASE DO NOT RETURN YOUR FORM TO THE ABOVE ADDRESS.

1. REPORT DATE (DD-MM-YYYY) April 2016		2. REPORT TYPE Final	3. DATES COVERED (From - To)		
4. TITLE AND SUBTITLE A Pictorial History of the Code 717 Unmanned Systems Group—Air, Land, and Sea Volume 1			5a. CONTRACT NUMBER		
			5b. GRANT NUMBER		
			5c. PROGRAM ELEMENT NUMBER		
6. AUTHORS H. R. Everett			5d. PROJECT NUMBER		
			5e. TASK NUMBER		
			5f. WORK UNIT NUMBER		
7. PERFORMING ORGANIZATION NAME(S) AND ADDRESS(ES) SSC Pacific, 53560 Hull Street, San Diego, CA 92152–5001			8. PERFORMING ORGANIZATION REPORT NUMBER TD 3289		
9. SPONSORING/MONITORING AGENCY NAME(S) AND ADDRESS(ES) SSC Pacific 53560 Hull Street San Diego, CA 92152–5001			10. SPONSOR/MONITOR'S ACRONYM(S)		
			11. SPONSOR/MONITOR'S REPORT NUMBER(S)		
12. DISTRIBUTION/AVAILABILITY STATEMENT Approved for public release.					
13. SUPPLEMENTARY NOTES This is work of the United States Government and therefore is not copyrighted. This work may be copied and disseminated without restriction.					
14. ABSTRACT Due to the large number of projects involved, this Pictorial History of the Code 717 Unmanned Systems Group is chronologically presented in three successive volumes: <ul style="list-style-type: none"> •Volume 1 (TD 3289) provides background information on the organizational structure, technology focus areas, key service areas, and facilities, followed by detailed project summaries for early work over the period 1970 through 1999. •Volume 2 (TD 3301) continues the project-summary discussions for those efforts begun in 2000 through 2009. •Volume 3 (TD 3302) continues the project-summary discussions for those efforts begun in 2010 through 2016. This is Volume I.					
15. SUBJECT TERMS Mission area: Unmanned Systems unmanned air, ground, surface, undersea vehicles; autonomy; perception; data mining; visualization; evolutionary systems engineering; standard test methods; rapid prototyping; command, control, and communications					
16. SECURITY CLASSIFICATION OF:			17. LIMITATION OF ABSTRACT	18. NUMBER OF PAGES	19a. NAME OF RESPONSIBLE PERSON
a. REPORT	b. ABSTRACT	c. THIS PAGE			H. R. Everett
U	U	U	U	234	19B. TELEPHONE NUMBER (Include area code) (619) 553-3672

INITIAL DISTRIBUTION

84300	Library	(2)
85300	Archive/Stock	(1)
71705	H. R. Everett	(97)

Defense Technical Information Center Fort Belvoir, VA 22060-6218	(1)
---	-----

Approved for public release.



SSC Pacific
San Diego, CA 92152-5001