

SUPER ARMATRON™

Cat. No. 60-2558

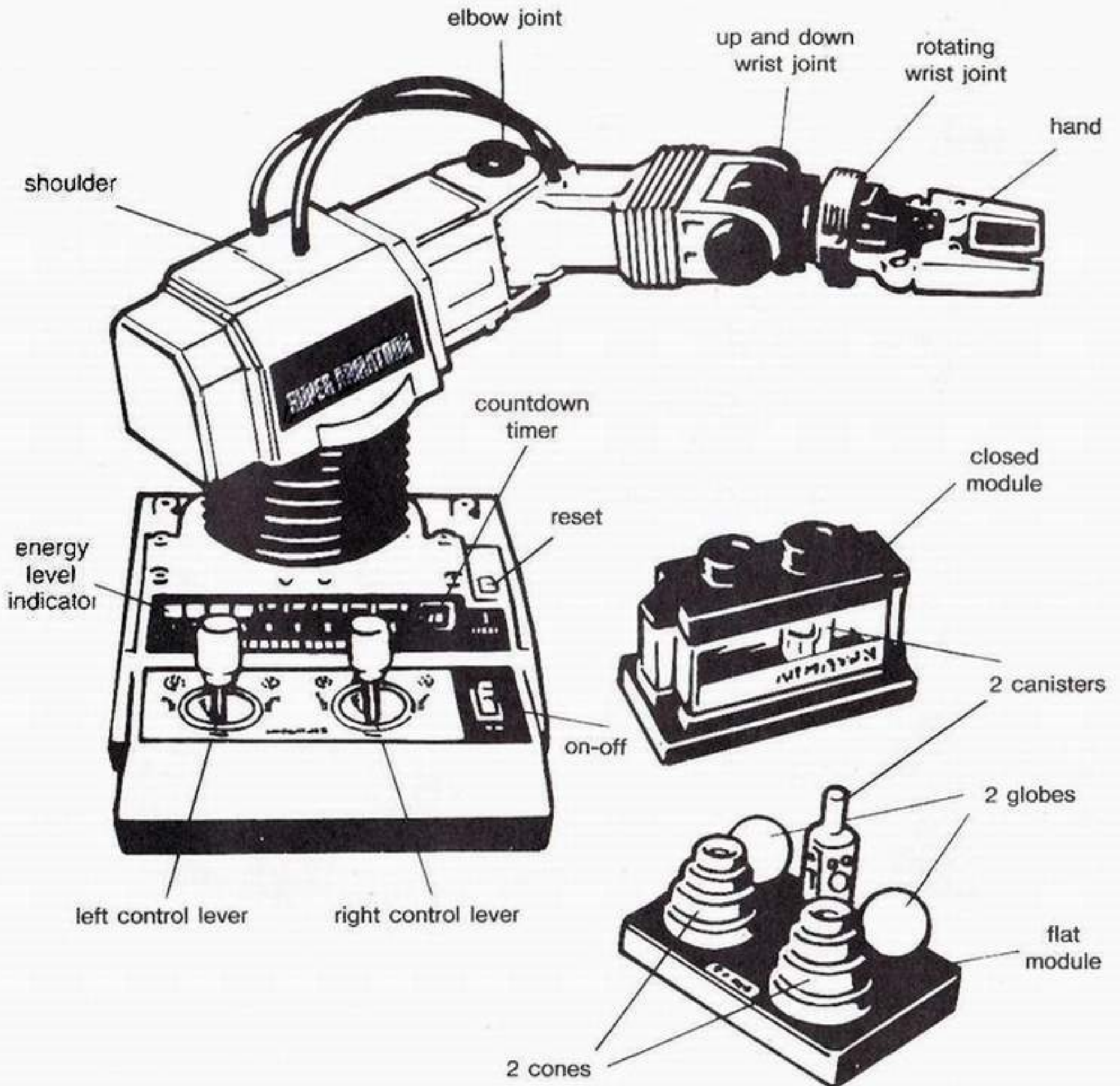

©1994 Tandy Corporation.
All Rights Reserved.

Radio Shack is a registered trademark used by Tandy Corporation.
Super Armatron is a trademark used by Tandy Corporation.

1 Decal Placement

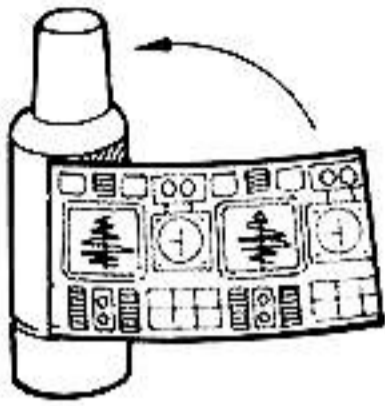

Wrap decals around both cannisters as shown above.

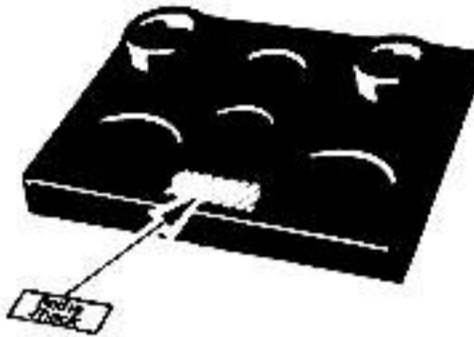

Place Radio Shack decal as indicated by the shaded area.

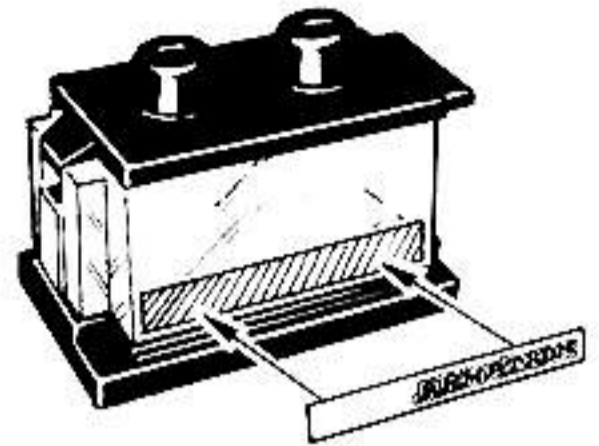

Position Armatron decal as indicated by the shaded area.

2 Batteries

Battery compartment is located on the bottom of the Armatron base.

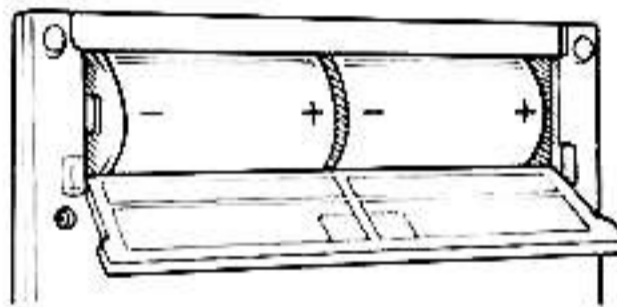

Use two D batteries. We recommend our Long Life (23-580) or Alkaline (23-550) batteries.

3 Reset Knob

The ENERGY LEVEL indicator consists of 10 energy levels (windows). Each window will register an orange or black color. An orange window indicates a charged energy level; black indicates that energy is discharged.

You lose one ENERGY LEVEL (orange to black) each time the countdown timer completes one revolution. The Armatron automatically turns itself off when all ENERGY LEVEL indicate black (total discharge).

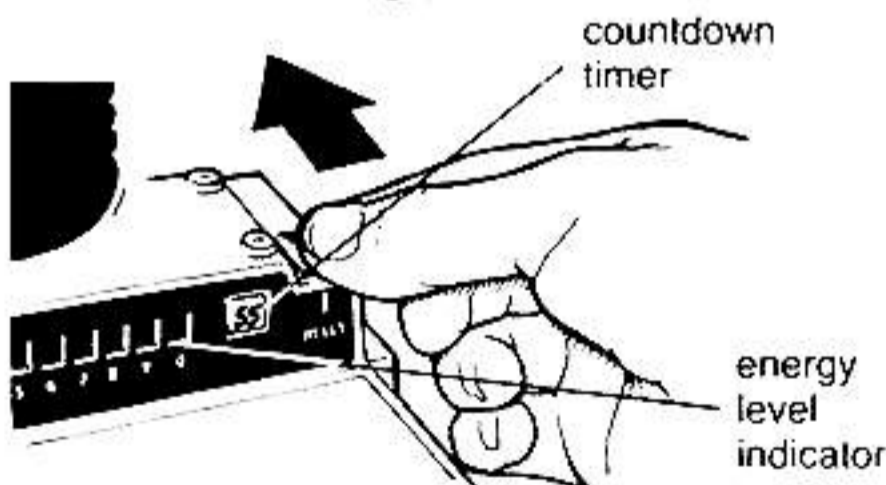

To begin, roll the RESET knob forward until the countdown timer reads "55". All 10 ENERGY LEVELS plus the countdown timer will register orange (indicating a maximum charge).

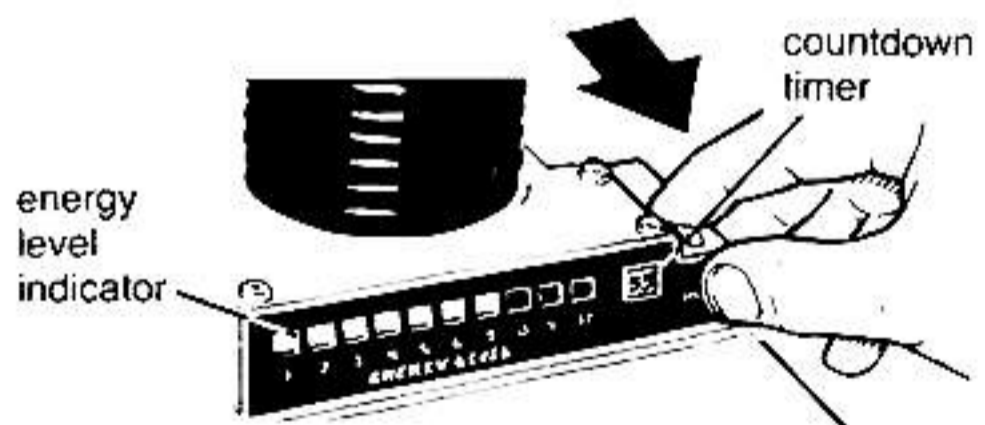

If you desire less than a full charge, simply roll the RESET knob backwards to obtain the desired energy level.

Turn the ON/OFF switch to on and you're ready to play. NOTE: The ON/OFF switch will not start the Armatron if all ENERGY LEVELS register black. To reset, follow the above instructions (refer to illustration).

5 2-Speed Control Levers

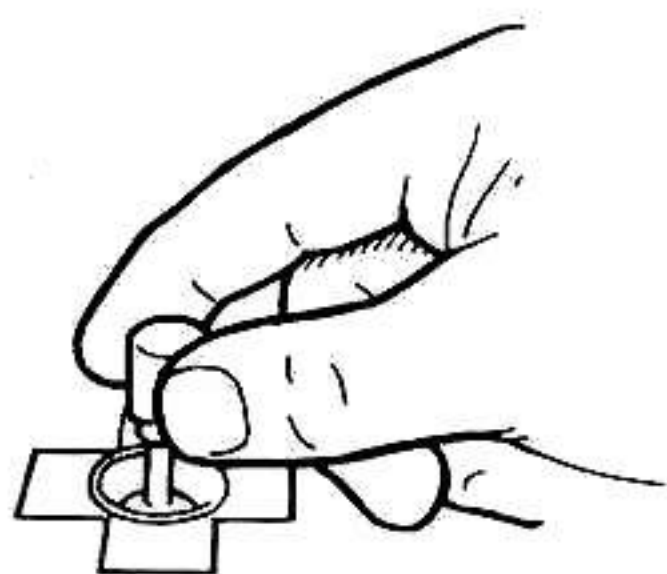

neutral
(center position)

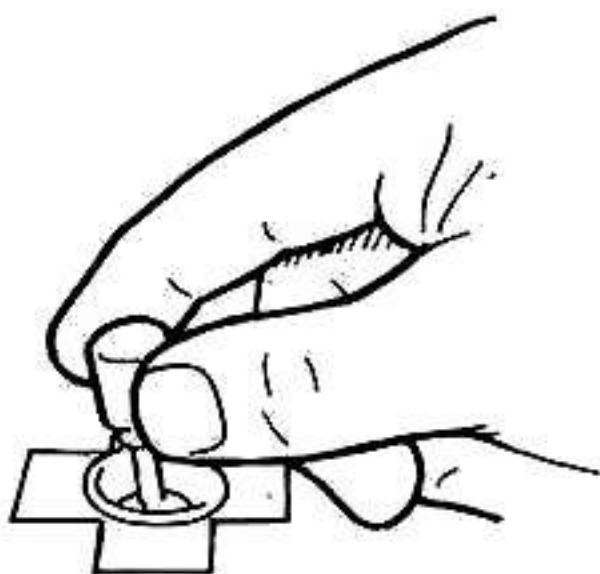

slow
(Push slightly in desired direction.)

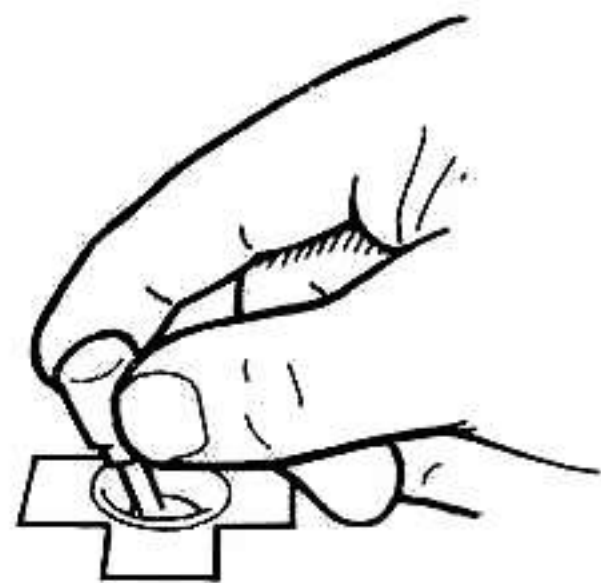

fast
(Push all the way in desired direction.)

6 Playing with Armatron

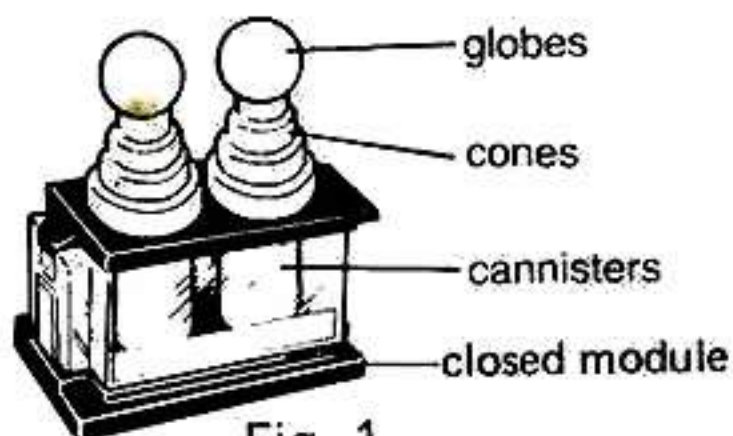
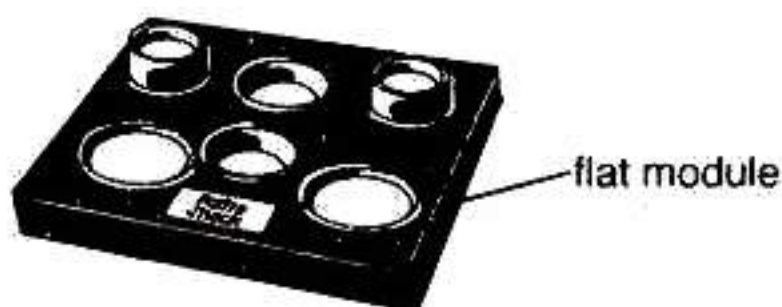

Fig. 1



Armatron is a game of skill and coordination. Play by yourself or challenge a friend. See who can manipulate this robot-like arm in a race against time.

1. First set up the energy module as shown in figure 1.
2. Next set the flat and closed modules about 8 inches from the center of the Armatron base as shown.

Each player is given the opportunity to set up Armatron and each module at the beginning of his turn. Once play begins Armatron base and modules cannot be moved.

TO PLAY:

Use your skill to transfer the globes and cones from the top of the closed module to the flat module. Once that mission is completed, use Armatron to open the closed module to reach the liquid fuel cannisters inside. Carefully lift the cannisters out one by one and place on the flat module. (Fig. 2) But watch out! If a cannister drops, it "blows" up and you lose the game. As soon as you have all of the pieces transferred, turn Armatron off. The number of orange energy levels you have remaining count for points towards your final score. Using the scoring below count the total points earned from successful unit transfers. Also count the number of points from remaining orange energy levels and tally your score. Highest score wins!

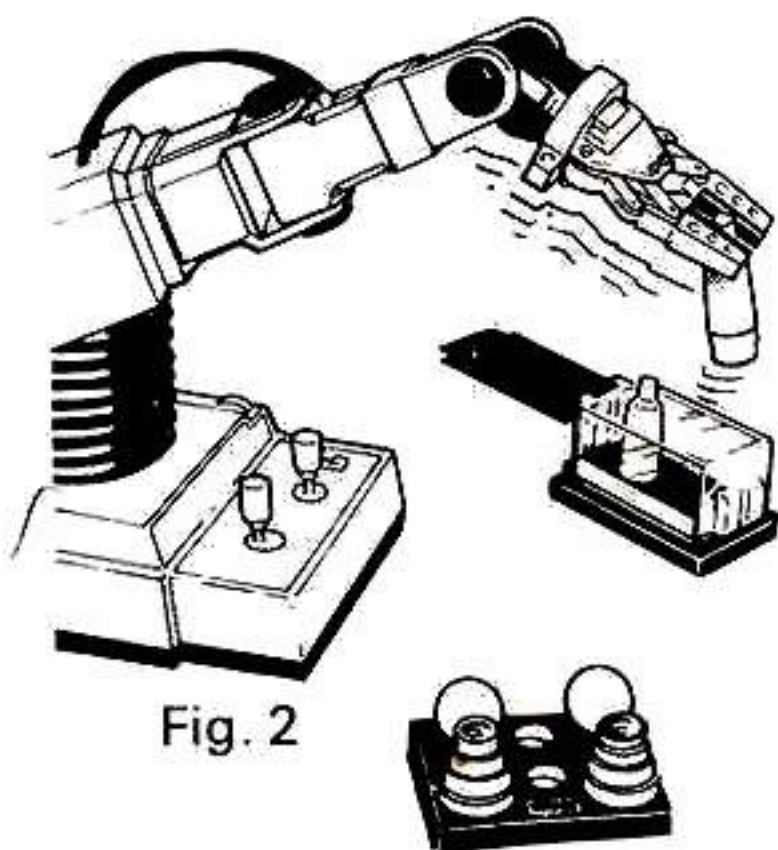
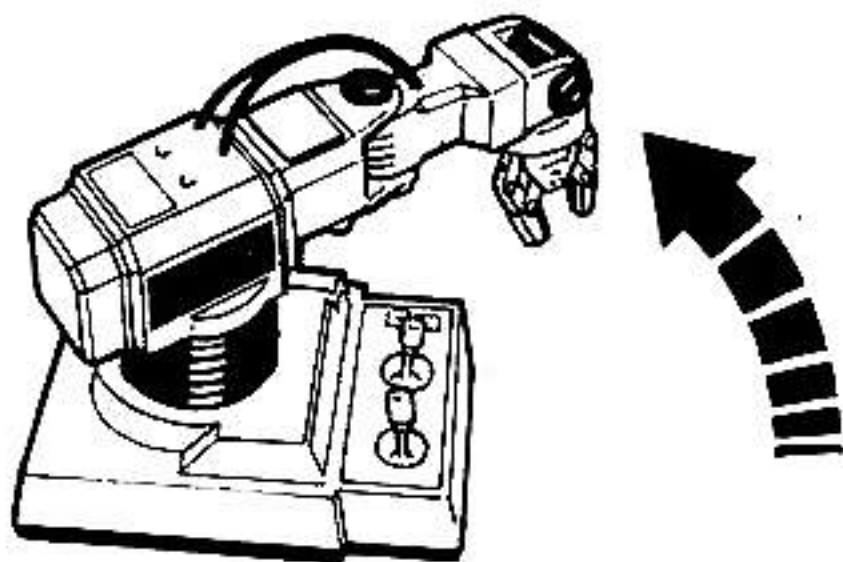
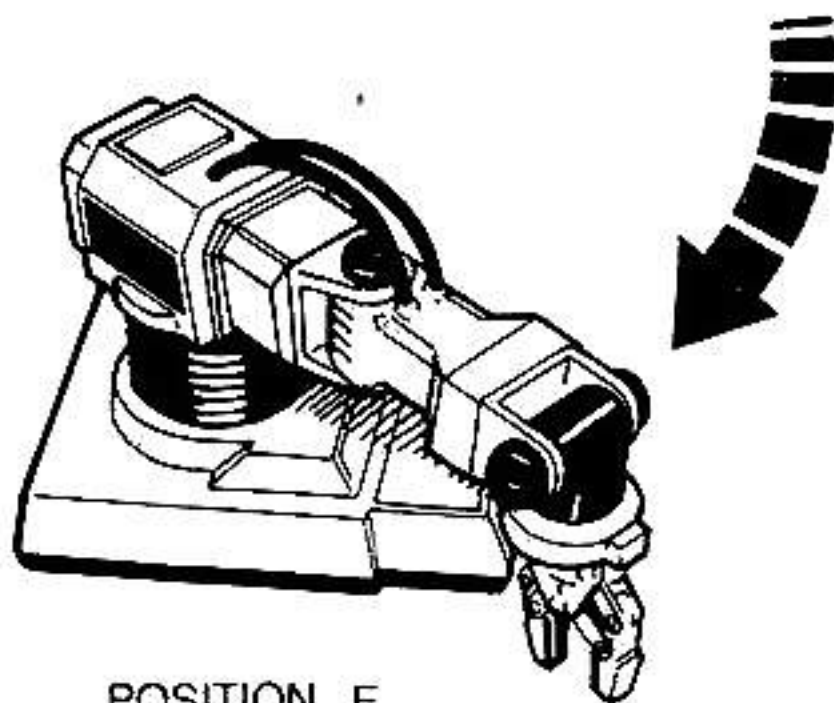

Fig. 2



POSITION E
Moves the entire arm
counterclockwise.



POSITION F
Moves the entire arm clockwise.

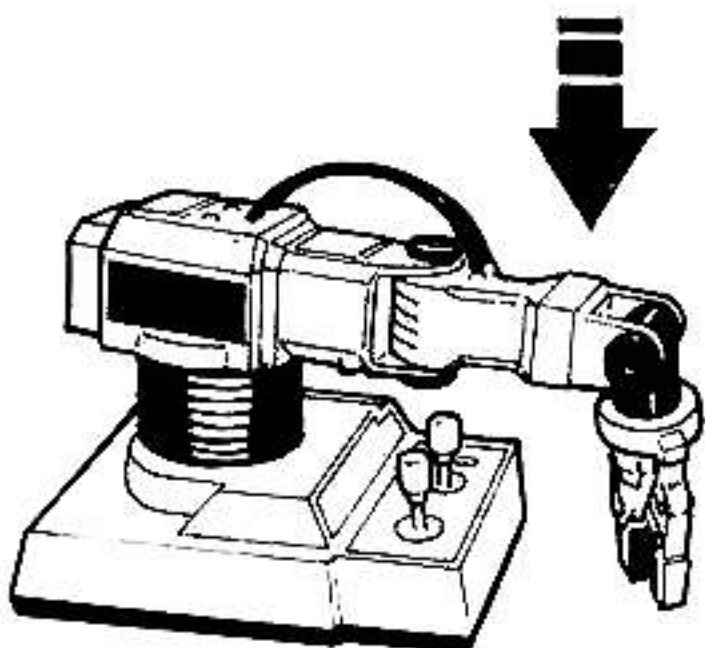

POSITION G
Moves the entire arm down.

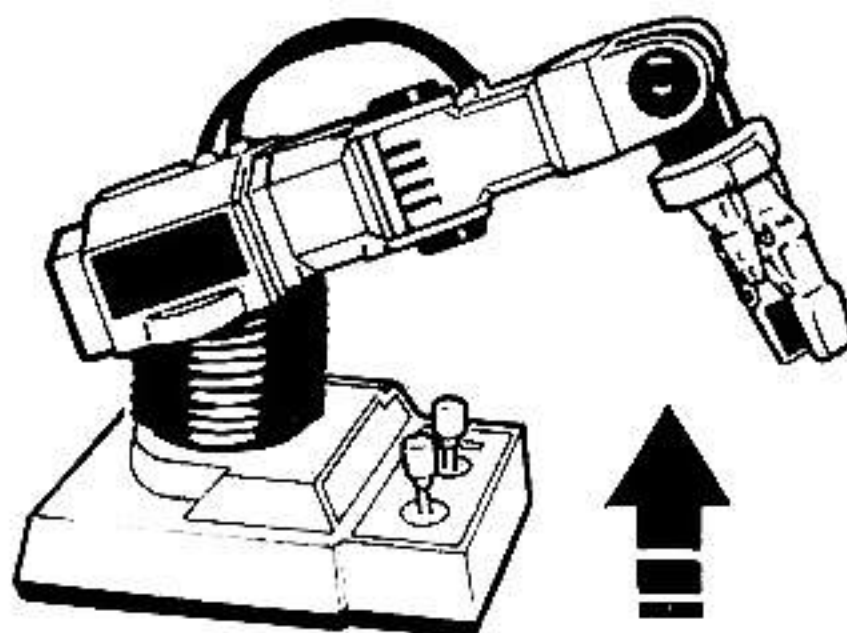

POSITION H
Moves the entire arm up.

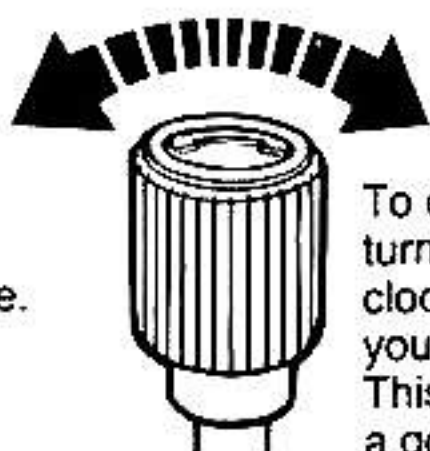

To open hand
turn the lever
counterclockwise.

To close hand
turn the lever
clockwise until
you hear it click.
This will ensure
a good grip on
the object you
are picking up.

LEFT CONTROL LEVER (I)

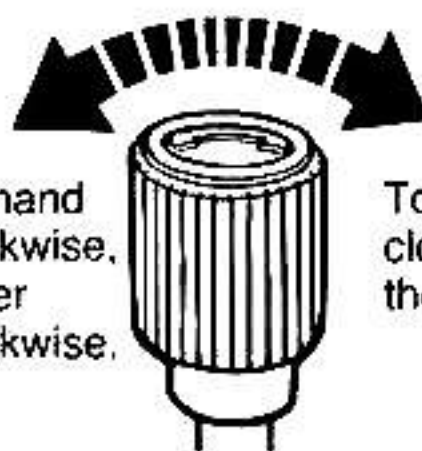

To revolve hand
counterclockwise,
turn the lever
counterclockwise.

To revolve hand
clockwise, turn
the lever clockwise.

RIGHT CONTROL LEVER (J)

4 Armatron Control Levers

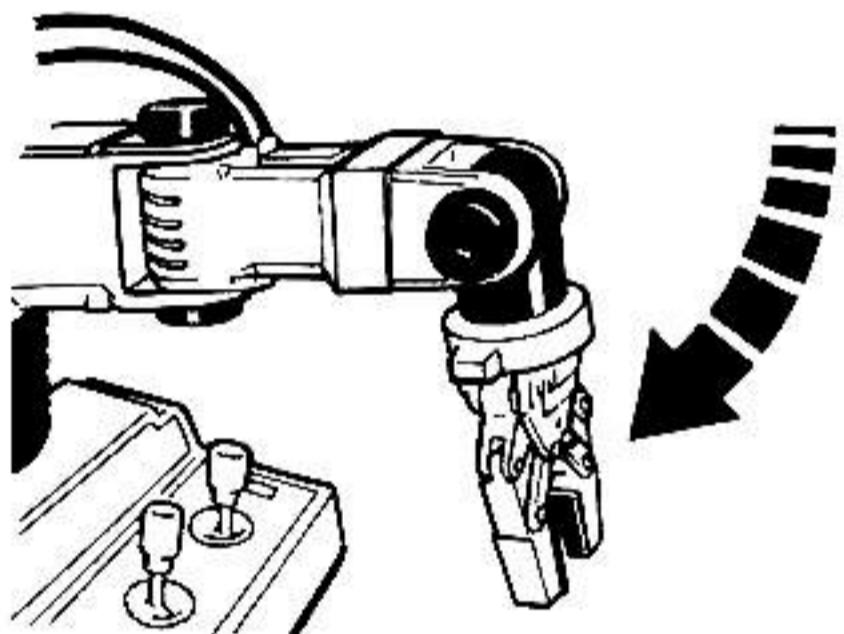
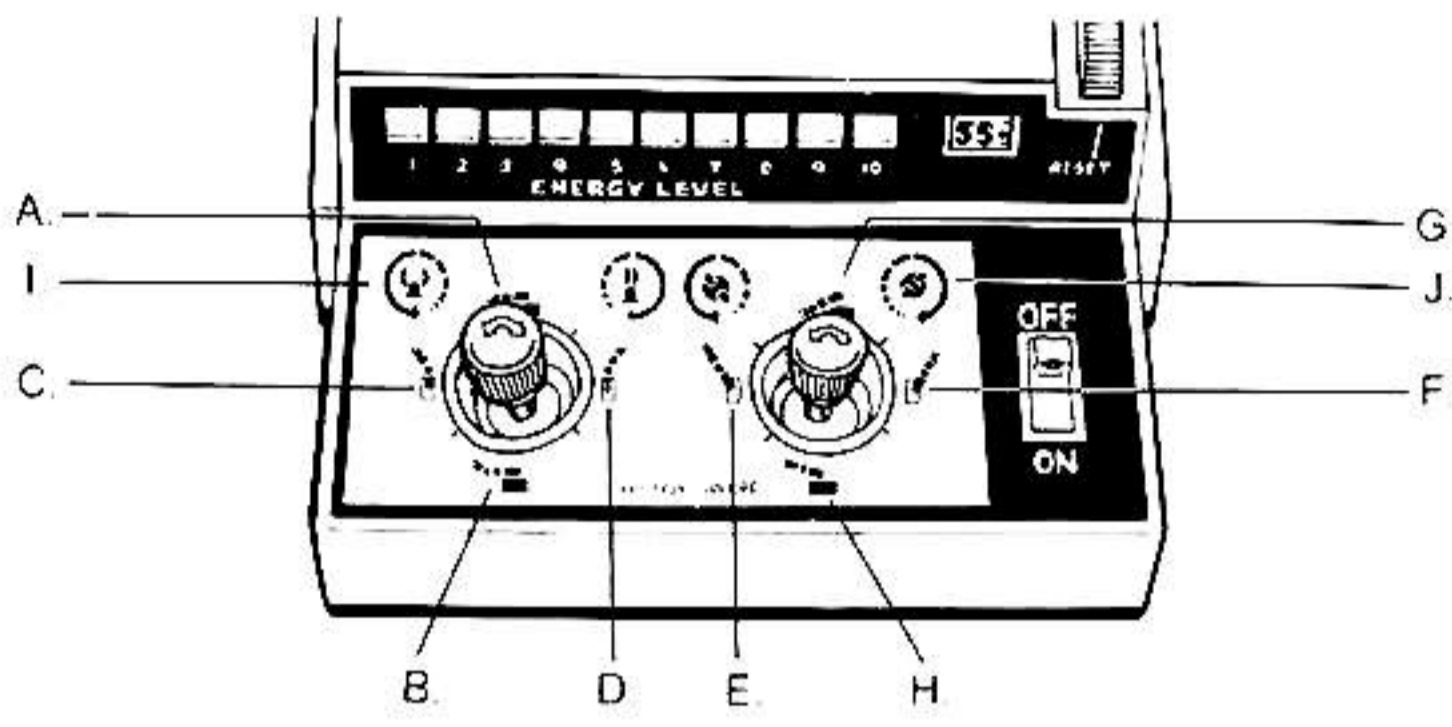

POSITION A
Moves the hand down.

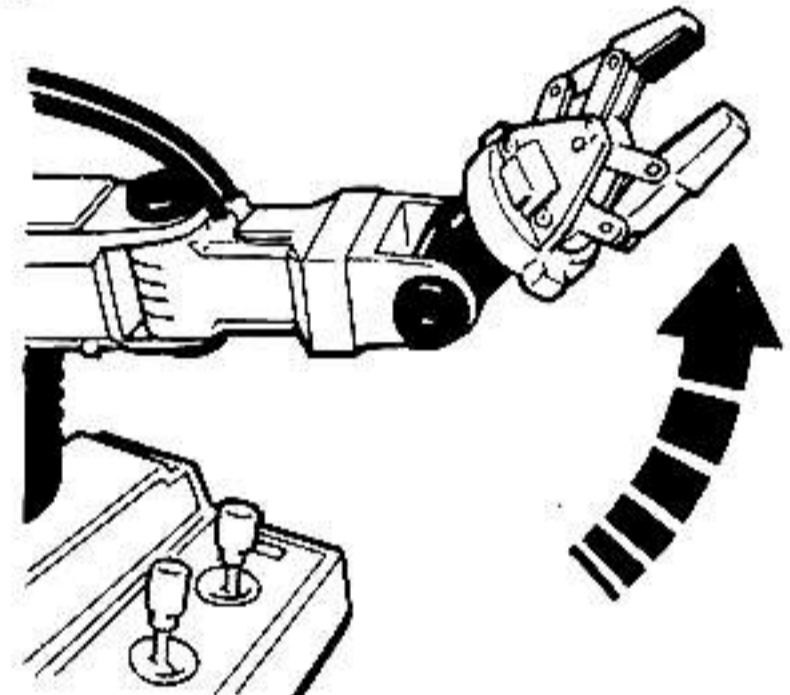

POSITION B
Moves the hand up.

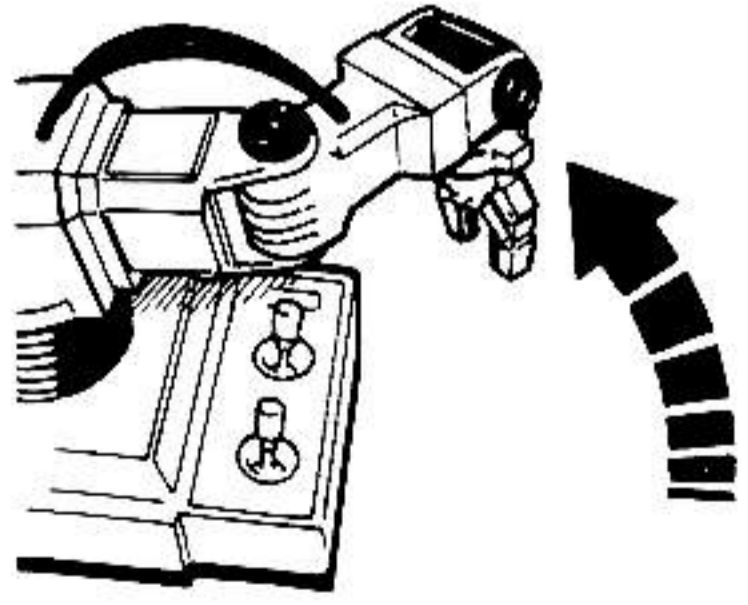

POSITION C
Moves the arm counterclockwise from the elbow joint.

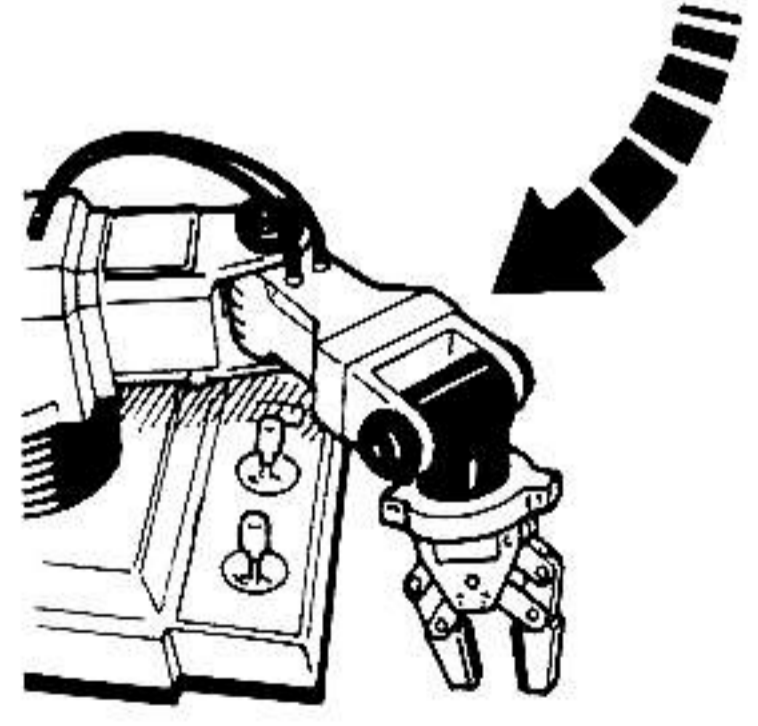

POSITION D
Moves the arm clockwise from the elbow joint.

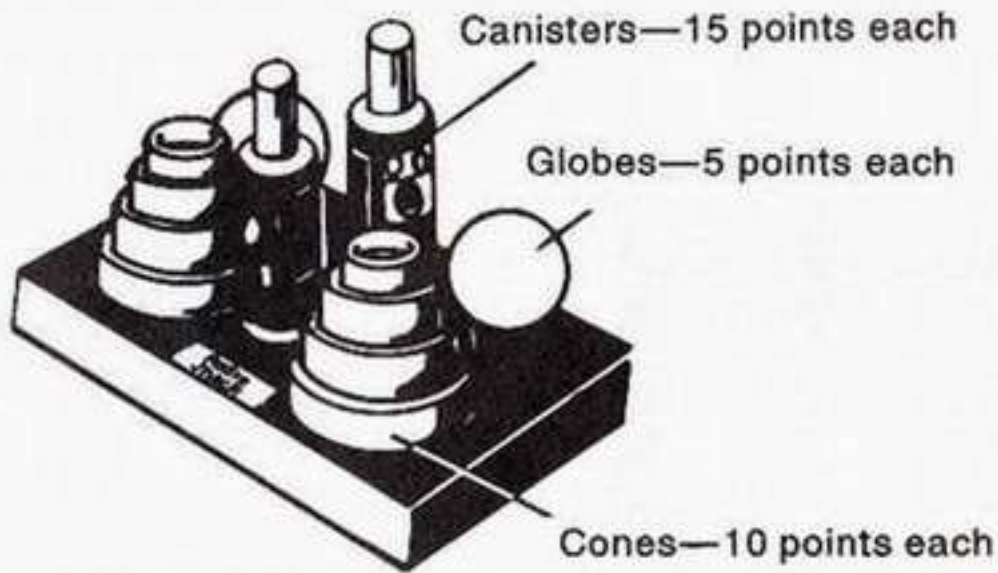

Scoring:

- Globes—5 points each
- Cones—10 points each
- Canisters—15 points each
- Each remaining energy level—10 points

Special Note :

In order to keep your Super Armatron working trouble-free, do not pick it up by the arm or dismantle it.

Care and Maintenance

- Keep the Super Armatron dry.
- Use fresh batteries. Remove old or weak batteries.
- Handle the Super Armatron carefully. Do not drop it.
- Keep the Super Armatron away from dust and dirt.
- Don't use the Super Armatron in temperature extremes.
- Wipe the Super Armatron with a damp cloth to clean it.
- Do not modify or tamper with the Super Armatron's internal components.

RADIO SHACK LIMITED WARRANTY

This product is warranted against defects for 90 days from date of purchase from Radio Shack company-owned stores and authorized Radio Shack franchisees and dealers. Within this period, we will repair it without charge for parts and labor. Simply **bring your Radio Shack sales slip** as proof of purchase date to any Radio Shack store. Warranty does not cover transportation costs. Nor does it cover a product subjected to misuse or accidental damage.

EXCEPT AS PROVIDED HEREIN, RADIO SHACK MAKES NO WARRANTIES, EXPRESS OR IMPLIED, INCLUDING WARRANTIES OF MERCHANTABILITY AND FITNESS FOR A PARTICULAR PURPOSE. Some states do not permit limitation or exclusion of implied warranties; therefore, the aforesaid limitation(s) or exclusion(s) may not apply to the purchaser.

This warranty gives you specific legal rights and you may also have other rights which vary from state to state.

We Service What We Sell

RADIO SHACK
A Division of Tandy Corporation
Fort Worth, Texas 76102